



Christian Puret

A graduate Engineer from the E.N.S.E.R.G. (Institut National Polytechnique de Grenoble) and the I.A.E. in Paris, he joined Merlin Gerin in 1977.

His first assignment gave him expertise in the field of programmable logic controllers. He was then put in charge of customer training for the Merlin Gerin Group.

In 1986, he rejoined the Medium Voltage Division in which he now holds a position involving strategic marketing. He is in charge of integration of developments in protection systems and telecontrol in MV equipment, and more specifically in those destined for public distribution networks.

n°155

MV public distribution networks throughout the world

glossary

Configuration : an operation, in both digital protection and telecontrol systems, that involves assigning, via either a built-in or a loaded software package, a standard piece of equipment to a specific application. The latter operation, loading a software package, is carried out using a tool : the configurator, normally a personal computer PC. This allows for example:

- definition of functions that the equipment will perform,
- devising of connections with the environment,
- creation of mimic diagrams and labelling of alarms for users.

Draw-out (part of an assembly) (IEC 50 - chapter 441, NF C 01- 441) : withdrawable part of an assembly that, whilst remaining mechanically attached to the assembly, can be moved to the position or one of the positions that gives an insulating distance or a metal separation between open contacts. This insulating distance or metal separation always intervenes in the main circuit. It may or may not also intervene in auxiliary circuits.

Fixed (fixed device), (IEC dictionary of electricity) : a device that is designed to be mounted on a fixed support and intended to be connected to external circuits using fixed electrical conductors.

Cut-out type fuse : MV striker-type fuse, that performs the two functions of protection and isolation. Isolation occurs when the fuse melts by ejection of the striker which in turn automatically triggers switch-over of the fuse cartridge.

Fault passage indicator : a device fitted to MV networks that indicates, fault passage either locally or at a distance. In order to improve quality of service, the operating company makes every effort to reduce the interruption in supply to that part of the network in which the fault exists. To achieve this they must know which portion of the network is affected by the fault. With this aim, the operating company installs fault passage indicators. Analysis of the information provided enables the faulty area to be closed off, followed by reconfiguration of the network (typical remote control application)

Prediction : a new science with the objective of event prediction, it is based on reasoning and scientific deduction.

Recloser : MV circuit breaker incorporating a multishot autoclosing relay, installed on an overhead MV feeder and coordinated with protection devices (fuses) placed on the feeder (upstream and downstream). It is used in North-American type distribution networks.

Sectionalizer : MV switch equipped with a fault passage counter, it is installed downstream of a MV overhead feeder protected by a recloser. Its automatic control counts the number of fault current passages (corresponding to the number of times the recloser is activated), and when a preset number has been reached it opens the circuit breaker. Selectivity can thus be obtained by installing several sectionalizers in series on a MV feeder, the last sectionalizer (which is furthest from the recloser) opening on the second instance of current fault, the preceding sectionalizer opening on the third occasion and so on. This device is used in North-American type distribution networks.

MV public distribution networks throughout the world

table of contents

1. Different types of electrical networks	The transmission and interconnection network	p. 4
	The subtransmission network	p. 5
	The MV network	p. 5
	The LV network	p. 6
	Type of electric current	p. 6
	Network planning	p. 6
2. The distributor	Reason of existence	p. 7
	His role	p. 7
	His development	p. 8
3. MV network topologies	Criteria in choosing a topology	p. 10
	Items that depend on the chosen topology	p. 10
	Various MV network layouts	p. 10
	Neutral earthing layouts	p. 12
	Protection system	p. 13
	Telecontrol system	p. 14
4. MV Public distribution	Substations on MV networks	p. 15
	Other MV installations	p. 16
	MV switchgear	p. 16
	French and North-American layouts	p. 18
5. Protection and control of MV networks	MV protection device technology	p. 20
	Electromagnetic compatibility	p. 21
	MV control applications	p. 21
	MV telecontrol architectures	p. 23
	Communications networks	p. 24
6. Conclusion		p. 25
Appendix 1: some MV product standards		p. 26
Appendix 2: various selectivity techniques		p. 26
Appendix 3: EDF architecture and Merlin Gerin equipment		p. 27
Appendix 4: references		p. 28

In a country, the Transmission and Public Distribution networks ensure the transfer of electrical energy from points of production to consumer units.

The points of production are power stations that generate electrical energy from various primary energy sources (nuclear, hydro-electric, coal....)

The points of consumption in MV - Medium Voltage -, are substations, from which the energy is delivered to customers (subscribers).

This takes place via the "MV distribution system" which is the object of this "Cahier Technique" report.

In this "Cahier Technique" report, after having described the various types of distribution networks and the distributor's role, the reader who is not familiar with MV will find details on:

- topologies of MV networks,
- substations,
- protection and telecontrol devices.

Comment: In this "Cahier Technique" report, the term MV applies to any voltage from a few kV to 40 kV.

1. different types of electrical networks

Producing electrical current in power stations is not enough in itself, it must also be brought to the end-user.

In order to link production and consumption, which in turn can be translated into financial benefit, a country's electrical structure is generally broken down into several levels that correspond to different types of electrical networks. (see fig. 1).

It should be noted that there is no standard structure that exists worldwide, and that the split into several networks with their

corresponding voltage levels can be different from country to country. However, in general the number of voltage levels is limited to three; indeed in 1983 the IEC publication 38 formulated recommendations for voltage levels for 50 and 60 Hz networks.

However, in order to gain better understanding of this split, the following paragraphs present each grid with:

- its object,
- its voltage level,
- its structure.

the transmission and interconnection network

The geographical distance between production sites and consumer centres, the irregularity of consumption and the impossibility of storing electrical energy create the need for an electrical network that is capable of directing and transmitting it across large distances.

These lines can stretch across thousands of kilometers, for example in the French network there exists 20 000 km.

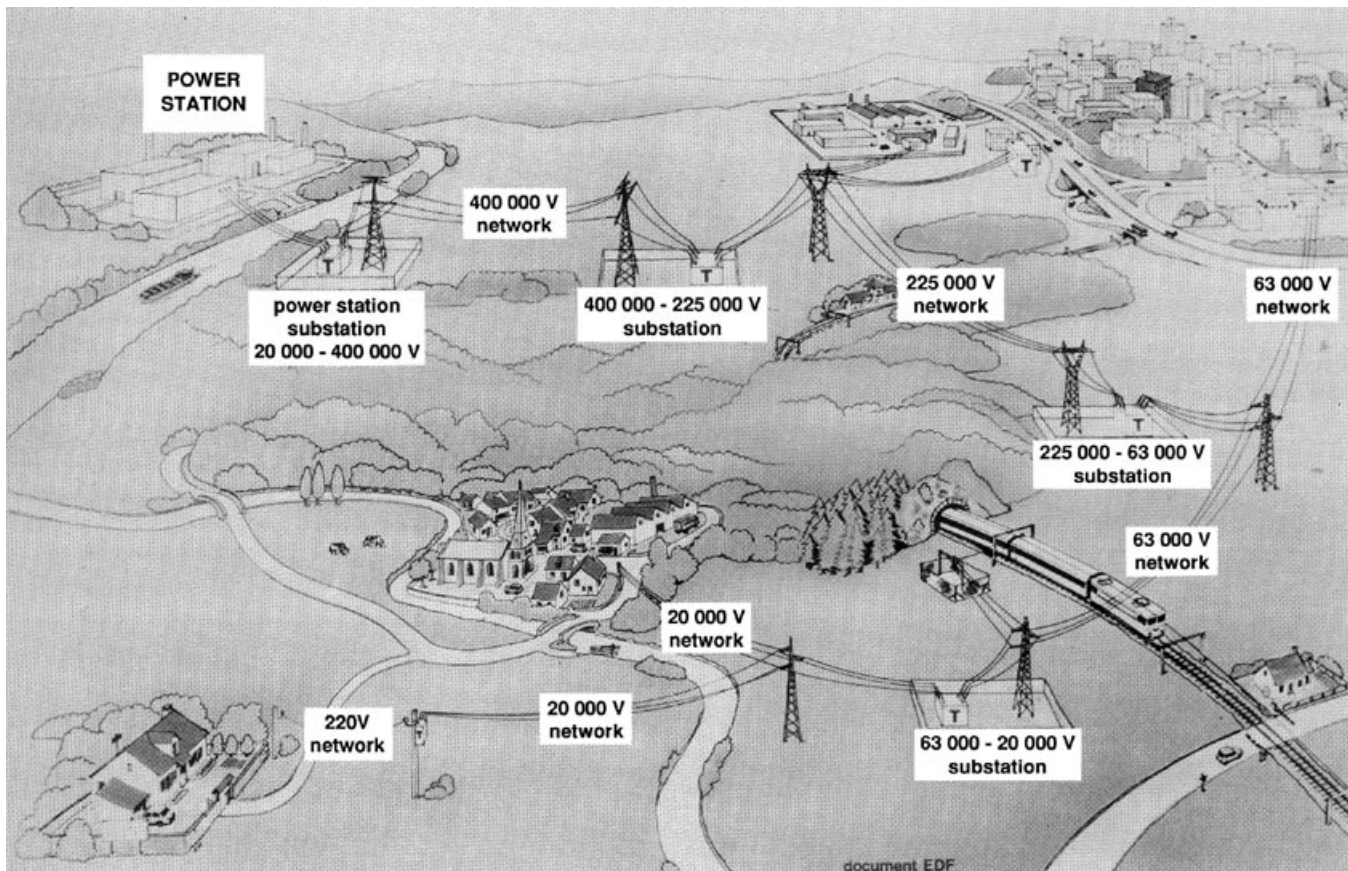

fig. 1: illustrated layout of an electrical network showing that electricity is produced, carried and distributed at various voltage levels.

The object of this network is threefold:

- a "transmission" function with the aim of carrying electricity from producing power stations to the main consumer zones;

- a "national interconnection" function that manages the product distribution by relating the production to the geographical and time-dependant nature of demand;

- an "international interconnection" function - that manages energy flux between countries dependant on programmed exchanges or as back-up.

In general only very few customers with a high consumption are connected to these networks.

These networks are essentially of overhead type structure.

The voltages are normally between 225 and 400 kV, and sometimes 800 kV (e.g.: 765 kV in South Africa). Use of such high voltages is tied in with cost saving objectives. Indeed for a given power, the line losses by Joule effect are inversely proportional to the square of the voltage:

$$p = k/U^2, \text{ with}$$

U = network voltage,

k = constant - dependant on the line.

In addition the transmitted power values are such that using low voltages would require totally unrealistic cable cross-sections. Use of high voltages is thus imposed in spite of the drawbacks involved in higher equipment insulation costs, the easiest solution being the use of overhead lines.

In any case, the choice of transmission voltage is above all a technico-economic one, dependant on the power to be transmitted and the distances to be covered.

The safety aspect is fundamental for these networks. Indeed any fault at this level leads to important supply failures for all consumer units. In 1965 in the United States, 30 million people were without electricity for 12 hours due to such a fault.

These networks' protection systems must be very high-performance. As for their operation on a national level, this is the task of a control centre from which the electrical energy is permanently monitored and managed.

the subtransmission network

The object of this network is essentially to carry electricity from the transmission network to the main consumer centres.

These consumer centres are:

- either from the public sector with access to the MV network,

- or from the private sector with access to high-consumption customer (greater than = 10 MVA) supplied directly with HV. In any country the number of such consumers is very small (e.g. 600 in France). They are essentially industries such as iron and steel, cement, chemicals, rail transport,....

The structure of these networks is generally of overhead type (sometimes underground near urban areas). In this respect environmental concerns (care for the environment and protection of certain natural sites) are often raised in opposition to the construction of lines. As a result it is more and more difficult and expensive for subtransmission networks to reach high population density areas.

Voltage in these networks is between 25 kV and 275 kV.

The protection systems are of the same kind as those for transmission networks, the control centres being regional.

the MV network

This level of a country's electrical structure will be covered in more detail in the chapters that follow. Thus, here we only give a few distinguishing features.

The object of this network is to carry electricity from the subtransmission network to points of medium consumption (greater than 250 KVA in France).

These consumer points are:

- either in the public sector, with access to MV/LV public distribution substations,

- or in the private sector, with access to delivery substations for medium consumption users. The number of these customers (e.g. 160 000 in France) is only a small proportion of the total number of customers supplied directly with LV. They are essentially from the tertiary sector, such as hospitals, administrative buildings, small industries,...

The structure is of overhead or underground type.

Voltage in these networks ranges from a few to 40 kV (see fig. 2).

Operation of these networks, can be carried out manually or, more frequently, by remote control from fixed/mobile control centres. However, in order to account of specific needs for

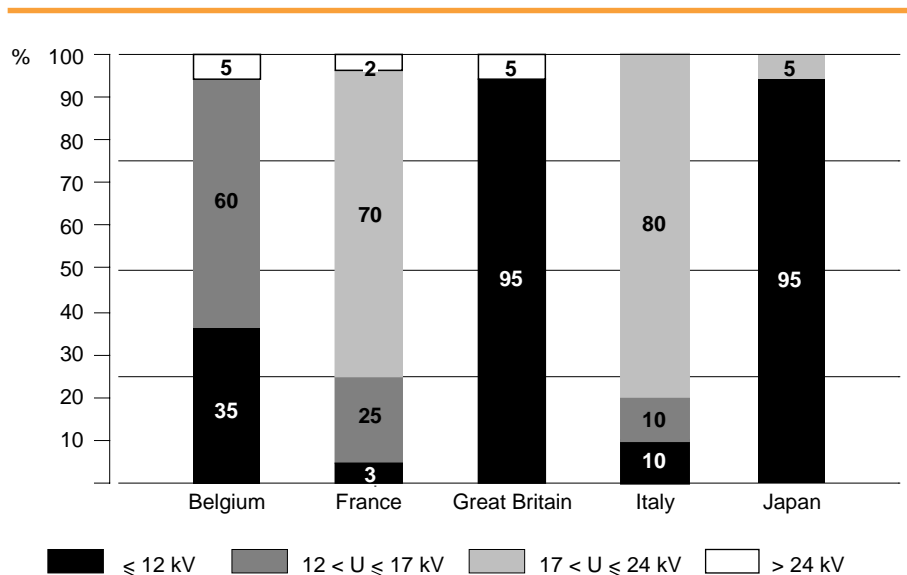

fig. 2: proportion of various voltage levels within national MV networks as a function of the lengths of lines of each country.

control of MV networks, these control centres are different to those used on transmission and subtransmission grid. The number and the geographical dispersion of remote control units, the management of several simultaneous control centres, the number and level of qualifications of the operators all require appropriate solutions: ergonomics and user-friendly type work stations, control assistance tools, control centre configuration tools, and management of the various transmission devices that are used.

the LV network

The object of this network is to carry electricity from the MV network to points of low consumption (less than 250 KVA in France) in the public sector with access to LV customers. It represents the final level in an electrical structure.

This network enables supply to a very large number of consumers (26 million in France) corresponding to the domestic sector.

Its structure, whether overhead or underground is often influenced by the environment.

Voltages in these networks are between 100 and 440 V.

Such networks are often operated manually.

type of electric current

Energy transmission on these various networks is accomplished using electric current.

Direct current or HVDC (high voltage direct current) links are used for exchanges between countries exclusively on a transmission network level. The choice of this technique enables optimization of the use of transmission cables, particularly by cancelling the "skin" effect. Such intercontinental and even continental links exist, for example a link between Italy and Sardinia via Corsica (300 MW/200 kV).

In other cases, particularly public MV networks, links are through alternating current. Indeed, in these networks, the use of direct current would not be profitable:

- losses reduced on short networks (less than 100 km),
- equipment made more expensive (requirement of numerous direct/alternating converters).

In addition, alternating current is very well adapted to voltage changes (transformers) in the course of its transmission as electrical energy.

With very few exceptions (Saudi Arabia), and outside of the American continent where 60 hertz is used throughout, the current frequency is 50 hertz.

Of particular note is the case of Japan where half of the country is on 60 hertz, and the other half on 50 hertz.

network planning

The installation and evolution of the structure of an electrical supply network for a country corresponds to planning operations.

For transmission and subtransmission, these operations are generally centralised, since:

- the decisions leading to a modification in the structure of such networks, for example the introduction of a new MV/LV substation, requires to take into account numerous technical and economical parameters;
- the number of these parameters involved and their possible interactions means that help from computerized tools is required, such as use of a database and of expert systems.

For MV and LV networks, the planning is, however, often decentralized.

2. the distributor

reason of existance: to supply electricity

The electrical energy distributors exist to supply electrical energy to consumers taking into account several objectives such as:

- continuity and quality of service,
- safety of people and goods,
- flexibility and ease of operation,
- commercial competitiveness.

his role

If electricity supply is satisfactory in industrialized countries, the degree of electrification still remains variable in certain other countries.

Varying objectives depending on the degree of electrification...

For countries that are not 100% electrified, the priority objective remains the improvement of this degree of electrification. To this end, investment is mostly in construction of networks and installations (see fig. 3).

However, the investment capabilities, sometimes reduced, can lead to solutions based on simplification of the networks' structure to the detriment of the system performance. In the same way, sometimes a lack of availability and competence of the operators can lead to over-simplified operation.

Varying situations in industrialized countries

In countries that are 100% electrified, there are considerable differences in uses of electrical energy:

- national electrical energy consumptions show great differences (see fig. 4). These differences are due to the size of country, to its economic growth (GNP) and to the weight of the industrial sector (example 40% of the French consumption).
- per capita consumption can vary by a factor of 10 between certain countries (see fig. 4). These differences are mostly due to the pricing policy of distributors, but also to climatic conditions.

The role of the MV distributor is not clear-cut: it often covers LV - Low Voltage - distribution and in some cases he is also in charge of transmission, for example:

- in Japan, nine regional private companies are each responsible for the production, transmission and distribution for their area,
- in Germany around a thousand companies are involved in the distribution of electricity. Around 1/3 have their own production facilities.
- in Great Britain production is the responsibility of two companies (NP - National Power - and PG - Power Gen). The NGC (National Grid Company) are in charge of transmission, and the regional distribution is looked after by around twelve Regional Electricity Companies. This structure is a result of a privatisation bill for British distributors voted in 1990.
- in Italy a law founded the E.N.E.L. in 1962. This is a public service responsible for the production,

transmission and distribution; it manages around 80% of the electricity distributed in Italy.

- in France the situation is similar with the E.D.F.

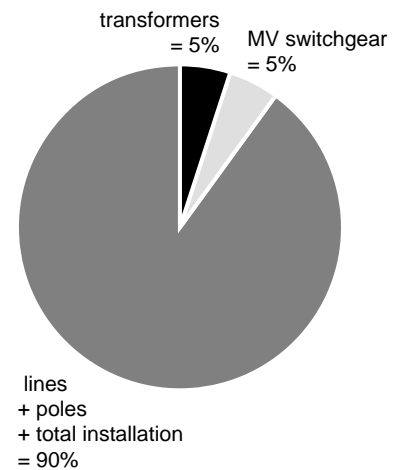

fig. 3: break-down of costs of MV overhead lines.

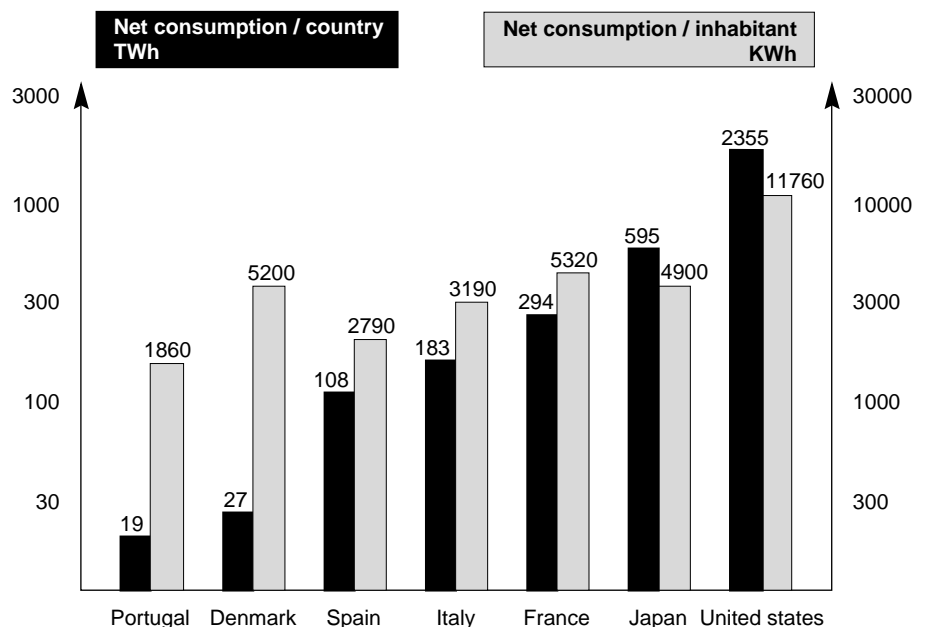

fig. 4: net consumption per country and per inhabitant.

These examples would thus appear to show that the number of parties involved, particularly in MV distribution, can vary considerably from country to country (see fig. 5).

In the case of MV distribution the distributor generally has complete responsibility for the network, from the HV/MV substation to the MV/LV transformer substation. In addition the distributor's job now includes a commercial aspect with respect to the sale of "electricity" as a product in the form of a kWh. He must thus continually improve the quality of the product to satisfy the demands of his various customers, and remain competitive in relation to other sources of energy. This objective leads distributors to consider several price levels dependant on the quality of kWh being sold.

Equally, the electrical network represents an important investment for the distributor. He has to make this investment as profitable as possible and it is for this reason that it is increasingly frequent that distributors' requirements include the idea of energy management.

Lastly, distributors play an important social and political role, a role which can have a bearing on his choices, or at least on their priorities, as in the following two examples:

- supplying new customers may require extension of the network,
- the price per kWh may be limited in line with government economic policy.

country	number of distributors		the most important
	total	distributing 80% of national consumption	
Germany	600	20	R . W . E .
Saudi arabia	5	5	S . C . E . C . O .
Spain	200	6	Hydro Electrica
France	200	1	E . D . F .
Great Britain	15	10	Regional Electricities C ^{ie}
Italy	150	1	E . N . E . L .
Japan	9	9	Tokyo Electric Power Co

fig. 5: electrical energy distributors in several countries.

his development: supply of high quality energy

Increasingly, the energy distributor is required to supply a high quality electricity product. In order to do this he must:

- reduce the number and the length of interruptions in supply to his customers,
- minimise the consequences of them,
- avoid disruptions such as voltage and frequency fluctuations (see fig. 6).

parameters	nominal values	tolerances
Frequency	(50 Hz)	± 1Hz
MV Voltage	(12 to 24 kV)	± 7%
LV Voltage	(230 or 400V)	
overhead		± 10%
underground		± 5%

fig. 6: examples of a distributors "quality" constraints (EDF France).

The type of faults depend on the type of network

For customers, the consequences of such phenomena depend above all on the type of fault.

A fault can be:

- momentary or permanent in duration;
- one-phase or three-phase dependant on the type of its cause.

A momentary fault often means a brief interruption of the order of several 100 ms, essentially related to the operating time of a recloser.

A permanent fault implies an interruption lasting between several minutes to several hours ; it requires human intervention.

Overhead networks, that are naturally considerably more exposed than underground grid, require specific solutions to problems encountered such as:

- tree branches falling on overhead lines;
- birds landing on the line or its supports;
- faults due to lightning, wind, frost, snow;
- vandalism.

As a consequence, the type of failures encountered differ between overhead and underground networks:

■ on overhead networks, the faults are mostly momentary (80 to 90%) and one-phased (75%) since they are often due for example to storms, to a line fallen to the ground or to shorting across an insulator.

■ on underground networks, the faults are mostly permanent (100%) and multi-phased (90%) since they are very often the result of severing a cable.

A need for information

The importance of understanding the incidents occurring on the network increasingly justifies a need for information that distributors satisfy by using statistical studies.

This analytical work aims to:

- classify and code the incidents,
- determine their origins and causes,
- statistically calculate their frequencies,
- search for correlations,
- study the comparative performances of the various topologies,
- analyse the results according to operating methods and installed equipment involved.

These statistics provide a tool for helping distributors in the design, operation and maintenance of public networks.

In addition, in order to be able to decide on the best solutions, the quality of service must be able to be quantified and measured, and no longer just be approached in a subjective manner. In order to achieve this, new tools have been designed (based on mathematical models), particularly including the idea of "undistributed energy". Notably, to measure the cost of low quality in

MV networks, the E.D.F. use the formula:

$A \cdot N \cdot P + B \cdot N \cdot P \cdot T$, with

N = number of permanent breaks per feeder,

P = average power per feeder in kW,

T = average length of interruption per failure,

A and B = economic value coefficients

(in 1990, for the EDF in France

A = 6 FF/ kW and B = 13.5 FF/ kWh).

However, measurement of the quality of service can require inclusion of even more parameters. The complexity of the calculations and simulations to be carried out, justifies the development of software tools that are increasingly powerful to help with the decision.

To measure the reliability of energy supply to a residential LV customer, distributors prefer to use the criteria of "degree of unavailability": this is the total annual time during which an average customer has his supply interrupted due to a fault on the electrical network (HV, MV or LV).

Lastly, it is important to note that for a LV customer, numerous incidents are due to the MV network (60% according to an EDF study) (see fig. 7).

Networks, equipment and operators, are all evolving

It should not be forgotten that a network's performance depends above all on its topology. However, throughout the world, present networks are simply the result of years of laying of structures one on top of the other as needs have increased. In addition a network ages and is constantly in need of maintenance and renovation work to retain its performance level and to avoid incidents, the sources of "undistributed energy".

To answer these needs, the manufacturers thus propose "maintenance-free" or reduced maintenance equipment; equipment for which maintenance, modification and addition type operations do not adversely effect the continuity of service.

In addition, energy distributors are not willing to undertake preventive maintenance, particularly device monitoring by recording and analysing incidents that occur on the network (use of "disturbance recorders" and time-stampers).

Advances in protection and telecontrol equipment with digital technology (microprocessor) and expansion of communication networks, offer the perspective of innovative solutions in terms of event prediction (see glossary).

Lastly, the practice of live-line repair work and remote control of the networks are also points that favour increased quality of service, by reducing the number of interruptions and their duration.

Of course, all of these developments require that the workforces should adapt quickly, following the example of the current changes in work practices in

control centres:

- there still exists control centres in which:
 - the status of various networks is indicated by manually displaced symbols on large charts several meters square in area,
 - and the instructions relating to operations are hand written in log-books;
- in new centres all these operations are performed on computer terminals, with:
 - all information available on screens in real time (network layouts, geographical description),
 - events logged automatically (data logging).

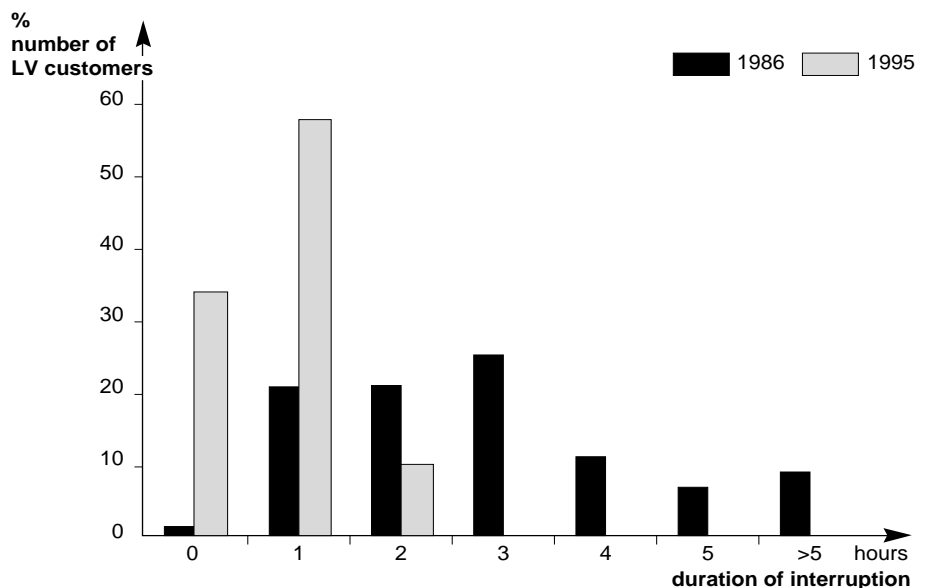

fig. 7: degree of unavailability of electrical energy on one LV network (EDF - France).

3. MV network topologies

The topology of an electrical network is defined here as all of the principles involved in carrying electrical energy in public distribution (layout, protection, operation).

In practice for a distributor, defining a topology means fixing a certain number of physical factors, whilst taking account of criteria dependant on objectives aimed for and technical constraints. Since these factors are closely interrelated, choice of a certain topology is always the result of technico-economic compromises.

Here, the graphical representation of a topology will be by simplified single-line layouts.

criteria in choosing a topology

The choice of a topology depends on meeting objectives:

- to ensure the safety of people and goods,
- to attain a pre-defined level of quality of service,
- to produce the desired profitability.

However, it must also meet certain requirements:

- to correspond to the housing density and/or to consumption, known as the load density, it plays an ever increasing role. Calculated in units of MVA/km², this density enables the expression of various geographical zones in terms of load concentration. Certain distributors distinguish two types of consumption zones by defining:
 - low load density zone: < 1 MVA/km²,
 - high load density zone: > 5 MVA/km².
- to account for the geographical spread, terrain and construction problems,
- to satisfy environmental constraints, particularly climatic (maximum and minimum temperatures, frequency of storms, snow, wind, etc.) and respect for surroundings.

items that depend on the chosen topology

The choice of a topology fixes the main design elements of a distribution system, such as:

- the rated power and the maximum value of earthing currents, e.g. for MV, the EDF limits the value of these currents to 300 A at 20 kV overhead and to 1000 A underground;
- the rated voltages, e.g.:for MV Japan supplies at 6.6 kV, Great Britain at 11 and 33 kV and France mostly at 20 kV;
- voltage surge ratings and coordination of isolation as well as protection systems against atmospheric voltages surges;
- the earthing connection layouts, as well as the number of distributed wires,
- the maximum feeder lengths (tens of kilometers at MV);
- the type of distribution: overhead or underground (see fig. 8);
- the type of operation: manual, automatic, remote controlled.

It is important to note that:

- the choice of short circuit current has repercussions on the rating of the equipment used in the network;
- the choice of voltage rating(s) is always a compromise between the installation and operating costs of the network;
- the choice of insulation rating of equipment is generally in line with international and/ or national standards;

■ the choice of an overhead or underground distribution system has a big influence on the installation costs and the quality of service (e.g.: costs of a trench / vulnerability to momentary faults...). For MV, in industrialized countries, this choice can be broken down into three cases:

- highly populated urban area with an underground distribution system,
- highly populated suburban area with underground or part-underground part-overhead distribution system;
- scarcely populated rural area with overhead distribution.

However it should be noted that historically, due to high initial costs, numerous urban areas have overhead distribution systems, as in Japan and the United States.

various MV network layouts

The choice of layout is important to a country: particularly for MV networks since they are of great length. Thus, for example, the total MV structure in France is around 570 000 km long, that of Italy being 300 000 km long and that of Belgium being 55 000 km long.

Several topologies exist:

- lattice type, closed loop topology,
- simplified lattice type, open loop topology,
- open loop topology,
- radial topology.

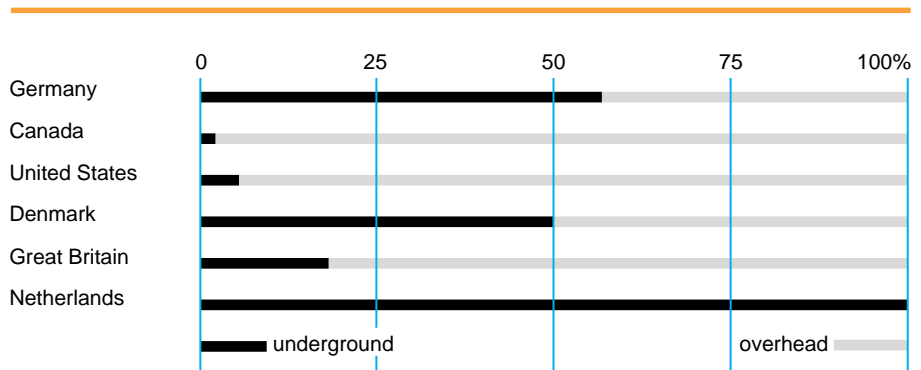

fig. 8: proportion of lengths of overhead (lines) and underground (cables) on MV networks, for several countries.

Other topologies are also used, for example the double shunt found on French MV networks.

Although none of them are "standard" in MV, distributors lean towards two base topologies: radial and open loop. Each of these two topologies will thus be covered in more detail and defined in terms of:

- its operating principle,
- its typical line layout,
- its typical application,
- its strengths and weaknesses.

Radial layout

This layout can also be called antenna-type.

Its operating principle is based on using a single supply line. This means that all consumer units in such a structure only have one possible electrical feed path. It is of arborescent type (cf. fig. 9).

This arborescence originates from supply points, that are MV/MV or HV/MV distribution substations.

This layout is particularly used for MV distribution in rural areas. Indeed, it enables easy and low-cost supply to low load density (≈ 10 kVA) consumer units with a wide geographical dispersion (≈ 100 km²).

Very often a radial layout is used with an overhead type distribution system.

Its strengths and weaknesses are summarized in the table in figure 10.

Open loop layout

Its operating principle uses two lines of supply. This means that any consumer

unit on this structure can be supplied via two possible electrical paths, whilst only one of those paths is activated at any one time, back-up is provided by the possibility of using the other loop. In such a layout, there is always an open point in the loop, which leads to a similar operation to two antenna layouts.

The typical line layout is, of course, a loop on which are connected consumer units (see fig. 9) which can be public distribution substations MV/LV, and/ or delivery substations for a MV customer.

technology	strengths	weaknesses
radial	<ul style="list-style-type: none"> ■ simplicity ■ operation ■ installation costs. 	<ul style="list-style-type: none"> ■ quality of service
open loop	<ul style="list-style-type: none"> ■ simplicity ■ quality of service 	<ul style="list-style-type: none"> ■ operation with more frequent switching ■ installation costs

fig. 10: comparative table of the two base MV network layouts.

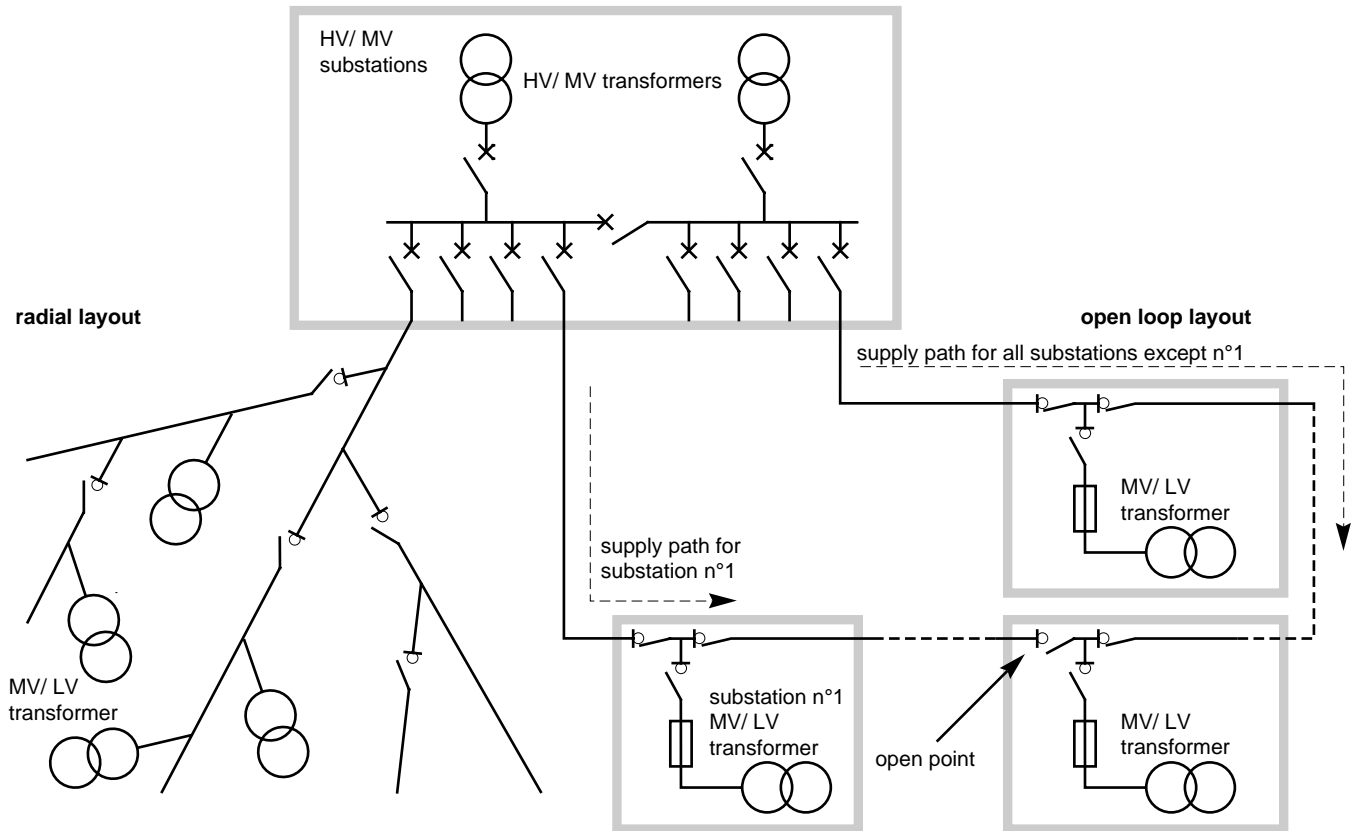

fig. 9: the two basic layouts of a MV distribution network, radial (or antenna) and open loop (or artery break).

Each point (between 15 and 25 points per loop) is connected to the loop by two MV switches. All these switches are closed, except for one of them that forms the opening in the loop and defines the feed path for each consumer unit. This opening can be displaced within the loop, particularly during reconfiguration operations following a fault.

Very often this layout is used in association with an underground type distribution system.

It is typically used in highly populated urban areas, and its strengths and weaknesses are detailed in the table, figure 10.

Double shunt layout

This rather uncommon layout is mostly used by the EDF in the Paris region, it is shown in figure 11.

The operating principle is the following:

- the MV network is doubled up, containing two circuits A and B, both normally live,
- every MV/LV substation
 - is connected to both MV cables ("A" and "B"), but it is only actually live to one of the cables (MV switch closed on cable "A"),
 - is equipped with a simple local automatic control device,
 - on failure of cable "A", the automatic control detects the lack of voltage in the cable, checks the presence of voltage in cable "B" and commands the closing of one MV switch and the opening of the other MV switch.

neutral earthing layouts

The choice of neutral earthing layouts (or neutral MV systems) defines amongst other things the voltage surge ratings and earth fault currents that could be found on a network. It must be noted that these two parameters are contradictory, in view of the fact that obtaining a low fault current level leads to a high voltage surge and vice versa. These values thus pose electrical constraints that the electrotechnical equipment must be capable of withstanding. However, in choosing the connecting layout, we simultaneously select the possible solutions for protection of the electrical network and influence the operating methods.

The five neutral earthing layouts used in MV throughout the world

Here again, no one standard neutral earthing layout exists. However, it is possible to bring together all the various cases met around the world into five categories (see fig. 12):

- direct distributed neutral earthing,
- direct non-distributed neutral earthing,
- neutral earthing via an impedance,
- neutral earthing via a designated circuit,
- neutral insulated from earth.

As has already been said, none of the categories is dominant throughout the world: some solutions are specific to some countries, and several categories can be found within one single country, or even within the network of one single electricity distributor.

But in the end, the choice of a MV neutral earthing layout is always the result of a compromise between installation and operating costs.

The differences between the five categories

It has been previously stated that the choice of neutral earthing layout influences the performance of the network and the design of its protection system. Indeed, the main differences between the five categories lie in the behaviour of the network in an earth fault situation.

These differences translate in real terms to the degree:

- of ease of detection of these faults,
- of security achieved for people,
- of impact on the requirements of electrotechnical equipment.

The distributed neutral earthing layout that allows single phase distribution should, however, be considered separately. This possibility can be considered in certain countries on the basis of its reduced installation costs. However, the more complex protection devices require stricter maintenance.

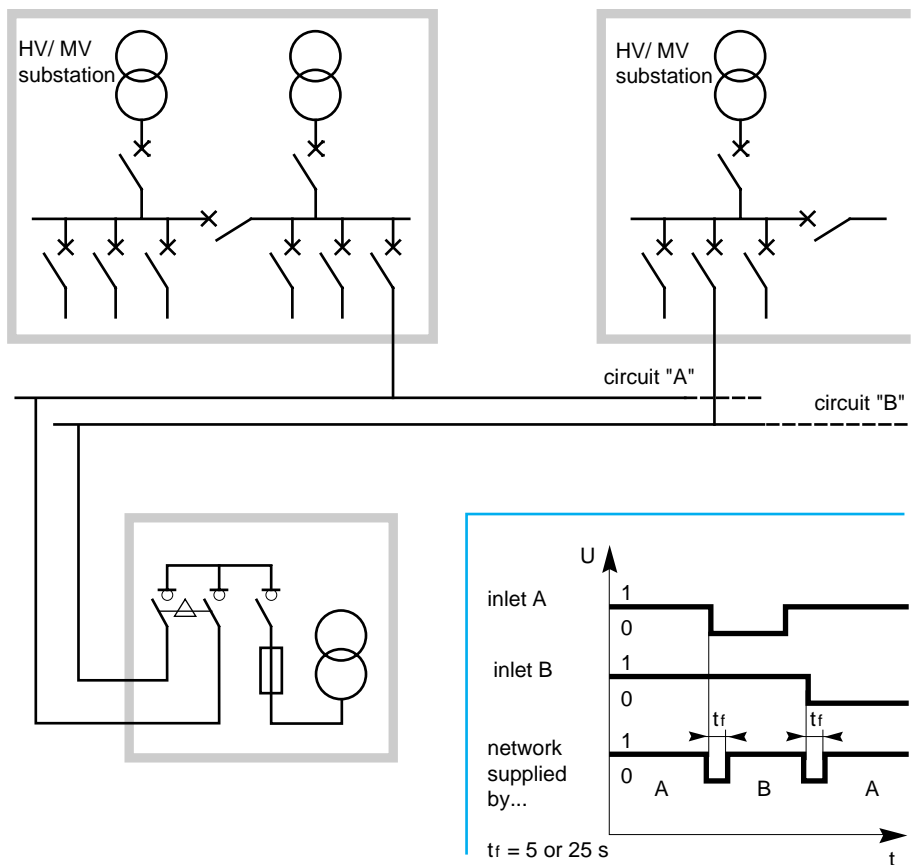

fig. 11: double shunt distribution layout, used by EDF - France. In the inset, automatic control sequence of Merlin Gerin permutator, conforming to EDF - France specifications.

Independantly of this particular case, the table in figure 13, a summary of the strengths and weaknesses of these categories, shows why no one of these categories is predominantly used throughout the world.

protection system

The electrical structure of a country corresponds to a group of electrical networks.

An electrical network can itself be broken down into areas.

Each of these areas is generally protected by a circuit breaker in conjunction with detector devices (measurement sensor: current or voltage transformer...), protection and control devices (protection relays), and trip devices (actuators).

All these elements together make up a chain of protection (see fig. 14) that ensures isolation of the faulty part of the network in the event of a fault. Its role is to ensure safety by protecting against insulation faults between phases or between phase and earth, and against prolonged overloading. The chain of protection must especially reduce the consequences of a short circuit, such as the risks of fire, explosion of mechanical damage,...

The network's protection system is made up of all of these chains of protection, integrating their installation with the organization of the operation between them. This protection system organization, including the trip times of the associated circuit breakers, defines the maximum duration of a current fault in the different parts of the electrical network.

The effectiveness of a protection system depends on several criteria: reliability, selectivity, rapidity, sensitivity, adaptability.

Reliability

This criterion describes the level of quality concerning safety of people and property, particularly in terms of dangers of electrocution by increased earth potential. Although a protection device is rarely activated, when there is a fault it must act effectively, throughout its many years of service. This criterion directly influences the network performance, thus, for example, any

method					
	neutral distributed with numerous earthing points	neutral earthed directly and undistributed	neutral earthed via an impedance	neutral earthed via a designated circuit	neutral insulated from earth circuit
country					
Australia	■				
Canada	■				
Spain		■		■	■
France			■		
Japan					■
Germany				■	

fig. 12: various MV neutral earthing layouts, and their applications throughout the world.

neutral earthing method	strengths	weaknesses
direct earthing and distributed	authorises one-phase and three-phase distribution	<ul style="list-style-type: none"> ■ requires numerous high quality earthing points (safety) ■ requires a complex protection system ■ leads to high values of earth fault currents
direct to earth and undistributed	eases detection of earthing faults	leads to high values of earth fault currents
insulated	limits earth fault currents	leads to surge overvoltage
designated	favours auto-extinction of earth fault currents	requires complex protection systems
impedant (compared with neutral direct to earth)	limits earth fault currents	requires more complex protection systems
(compared with neutral insulated from earth)	reduces surge overvoltage	leads to higher earth fault currents

fig. 13: a summary of strengths and weaknesses of the five MV neutral earthing methods.

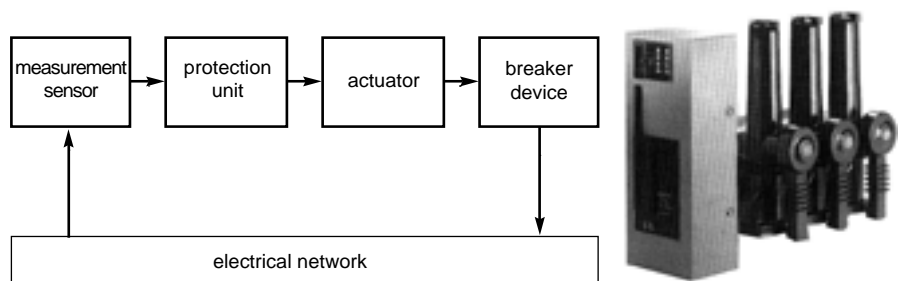

fig. 14: MV chain of protection, and photograph of a SF set (Merlin Gerin), an example of complete integration.

interruption in supply must be "justified" since it entails a loss of operation for the customer ... and the distributor.

Sensitivity

This criterion also has a bearing in terms of security and costs: it describes the ability to detect weak fault currents without being sensitive to transitory phenomena due to the network (operations) or to surrounding electromagnetic effects, thus before there is any risk to people or property, and that without tripping prematurely.

Selectivity

This criterion has a particular bearing on costs of operation, since it indicates to what degree it is possible to maintain the network operation whilst one part of it is not working as it should do. In practice, this leads to shutting off the faulty element, and only the faulty element (see appendix 2: different selectivity techniques).

Rapidity

This criterion, as in the preceding case, has an effect on costs: it enables reduction of the damage due to electrical arcs and short circuit currents, it particularly reduces the risk of fire and the costs of repair work.

Adaptability

This criterion particularly interests the distributor and indicates the degree of evolution that is possible (possibilities and ease) for the protection system with regards to modifications to the network topology.

Of all these criteria, selectivity is the one that leads to the most varied solutions from country to country. They depend on two initial choices made by the energy distributors:

- of which neutral earthing layout is used, from which we define notably the protection systems against earthing faults (see previous section).
- and that of which selectivity principle will be used, of which the most commonly used, called ampere-chronometric selectivity, is based on the association of the fault current rating (ampere-metric selectivity) and a value of the tripping delay time (chronometric selectivity). However, several different techniques can exist within the same network, in South Africa for example E.S.C.O.M. uses within one network, ampere-chronometric selectivity, pilot wire

between HV/MV and MV/MV substations and biased differential for HV/MV transformers. Lastly, distance selectivity technique is mostly used by German distributors.

telecontrol system

Under the one term of telecontrol are grouped all of the elements tied in with operation of the network.

A telecontrol system defines all of these elements and their relative operational organization. In this way the telecontrol system must enable the operator (the distributor) to account for 3 situations

- normal operation,
- the instance of a fault,
- maintenance operations (live and dead).

Lastly, the operating tools installed in this system are going to make a considerable contribution to the quality of service that is obtained.

These tools range from the push-button control of a MV device up to the MV network control centre, from the ammeter on a MV cubicle up to a automatic remote reading of the load curve for a MV feeder, etc...

4. MV public distribution

This chapter is a reminder of the main substations installed on MV networks, and the main technologies used in MV equipment. It is concluded by two layouts showing their applications in real terms.

substations on MV networks

A substation or installation is a physical entity defined by its position and its function within electrical networks.

The role of a substation is essentially to perform the transition between two voltage levels and/ or to supply the end user.

The HV/MV substation in a public distribution system

This installation is present in any of a country's electrical structures; it is positioned between the subtransmission network and the MV network.

Its function is to ensure transition from HV (≈ 100 kV) to MV (≈ 10 kV).

Its typical layout (see fig. 15) involves two HV inputs, two transformers HV/ MV, and 10 to 20 MV feeders. These feeders supply overhead lines and/ or underground cables.

The MV/MV substation in a public distribution system

This installation performs two functions:

- to ensure the demultiplication of MV feeders downstream of HV/MV substations (see fig. 15). In this case, the substation does not include a transformer. It is made up of 2 MV inputs and 8 to 12 MV feeders. This type of substation is used in several countries like Spain, Belgium, South Africa.

- to transfer between two MV voltage levels. Such MV/MV substations do contain transformers. They are necessary in countries that use two successive voltage levels in their MV networks, for instance in Great Britain where the MV network is broken down into two levels 11 kV and 33 kV. Their typical layout resembles that of the HV/MV substation.

The MV/LV substation in a public distribution system

Positioned between the MV network and the LV network, this installation

performs the transfer from MV (≈ 10 kV) to LV (≈ 100 V). The typical layout of this substation is of course a lot more simple than the

HV/MV substation

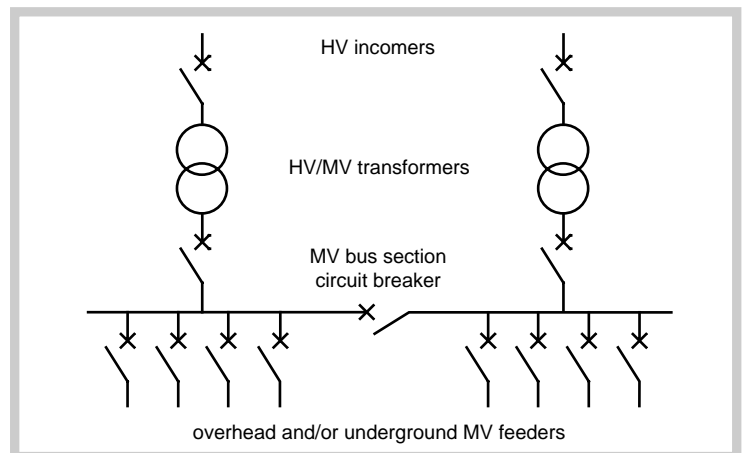

MV/MV substation

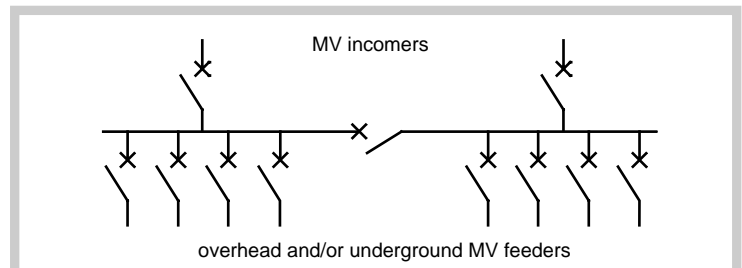

MV/LV substation

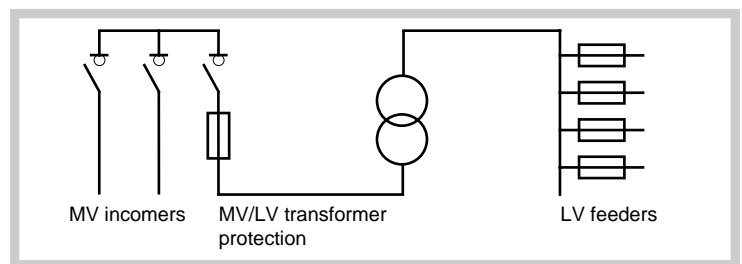

delivery substation for a MV customer

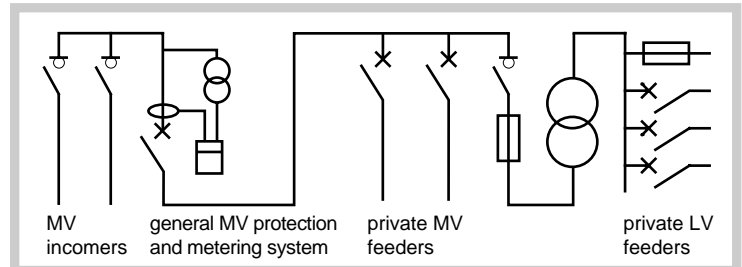

fig. 15: various layout types for substations used on public distribution networks

previous installations. In particular, the most common MV device used is the switch and no longer the circuit breaker.

These substations are made up of four parts:

- MV equipment for connection to the upstream network,
- the MV/LV distribution transformer,
- the LV feeder board as connection to the downstream network (in LV),
- and increasingly frequently a pre-fabricated outer enclosure (in metal or increasingly frequently in concrete) to enclose the previous elements.

The delivery substation for a HV or MV customer

These installations perform the transfer from public distribution to private distribution. They enable connection:

- to the HV subtransmission network for a high-consumption customer (\approx MVA) via a HV/MV substation,
- to the MV network of a medium-consumption customer (\approx 100 kVA) via a MV/LV substation.

The choice of the connecting voltage to the public distribution network for a customer depends essentially on:

- the quality of the LV network, particularly its power capacity (electrical capacity);
- the distributors policy, particularly on the rates offered, since for the customer this defines the cost saving advantages of electrical energy, compared with other sources of energy: oil, gas,...

In practice, it is the power subscribed to by the customer that determines whether he is connected to LV or MV, with very different values from country to country. Thus, in France a customer is supplied MV from 250 kVA whereas in Italy this threshold is nearer several tens of kVA. On the other hand in the United States where a customer can be supplied LV up to 2500 kVA. For users supplied with HV, the layout of the substation is specifically designed.

However, if the user is supplied with MV, a standard layout may be proposed (see fig. 15). Installation of such a substation is, however, evidently dependant on the distributor's agreement since they may have their own specific requirements (metering, operating conditions,...)

other MV installations

Outside of the substations already described, other MV installations exist that are mainly positioned on overhead networks. Often single function, they are used

- either as protection, as in the case of fuses and reclosers (glossary).
- or for operation, as in the case of remote control switches.

The MV remote control switch is part of network remote control systems. It allows rapid reconfiguration operations without the operator having to travel.

MV switchgear (see appendix 1)

MV switchgear enables the three following basic functions to be performed:

- isolation, which consists of isolating a part of the network in order to work on it in complete safety,
- control, that consists of opening or closing a circuit under its normal operating conditions,
- protection, that consists of isolating part of a network with a fault in it.

It essentially takes three forms:

- separate devices (see fig. 16) (directly fixed on a wall and protected from access by a door),
- metal enclosures (or MV cubicles) containing these devices,
- MV boards that are made up of several cubicles.

The use of separate devices is increasingly rare; only several countries such as Turkey or Belgium, still use this technology.

Amongst all the various types of devices, two are particularly used in MV switchgear, the circuit breaker and the switch. They are virtually always combined with other devices (protection and telecontrol units, sensor measurement units,...) that make up their associated equipment.

■ MV circuit breaker

Its main function is protection, but also performs a control function and, depending on its type of installation, a switching function (draw-out, glossary). MV circuit breakers are nearly always mounted in a MV cubicle.

■ MV switch

Its main function is command, but also often performs a role of switching. In addition, it is combined with MV fuses to ensure protection of MV/LV transformers (30% of all MV switches used).

MV cubicles have metal enclosures that meet specifications laid down in the publication IEC 298 that differentiates four types of switchgear, each type corresponding to a level of protection against fault propagation within a cubicle.

This protection system involves partitioning of the cubicle into three basic compartments (see fig. 17):

- the switchgear compartment containing the device (MV circuit breaker, MV switch,...),
- the MV busbars for electrical connections between several MV cubicles grouped together on a board,
- MV cable connections compartment, often with space for measurement sensors.

Often a fourth compartment completes this assembly, it being the control compartment (or LV box) containing protection and control units.

In addition to this classification the distinction should be noted between Fixed and Draw-out (see glossary) that apply to the MV device and cubicle. This distinction, that depends on the

MV devices	isolator	switch	circuit breaker	switch isolator	draw-out circuit breaker	fuse
isolating	■			■	■	
command		■	■	■	■	
protection			■		■	■

fig. 16: various functions of MV devices that are used in public distribution (contactors are essentially used in industry).

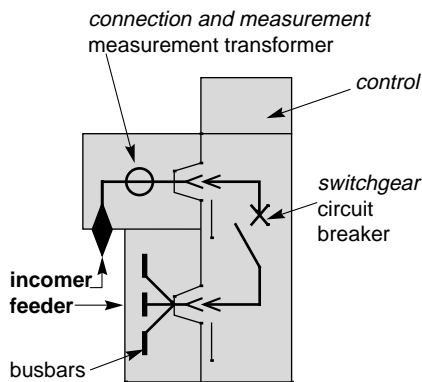

fig. 17: various compartments of a MV cubicle, surrounded with a metal enclosure, and their main elements.

ease of operation (as a function of time taken to change a device), is only indirectly involved in the idea of MV network safety.

IEC 298 defines the following four types of switchgear for MV cubicles:

- "BLOC" switchgear divided to a greater or lesser extent into compartments;
- "COMPARTIMENTED" switchgear, of which only the outer enclosure is obliged to be metal, has the three compartments separated with metal or insulated partitions;
- "METAL CLAD" switchgear also has distinct compartments, but of which the partitions are obliged to be metal;
- "GIS" switchgear (Gas Insulated Switchgear) that is hermetically sealed and within which the compartments no longer play an important safety role. The GIS is essentially made up of circuit breakers.

This technology is also applied to switches within a RMU (ring Main Unit). It provides the three standard functions to be performed of a MV/LV substation that is connected to an open loop network (two connecting switches to the network plus a tee-off fuse switch or a circuit breaker as protection of the MV/LV transformer).

The table in figure 18 shows the switchgear that is most often used as a function of the type of substation, whereas the table in figure 19 shows the current importance and trends of various MV breaking techniques.

substation switchgear	public HV/MV	public MV/MV	public MV/LV	HV/MV customer	MV/LV customer
separate device			S		S
bloc		CB or S	S	CB	CB or S
compartmented		CB or S	S	CB	CB or S
metal clad	CB	CB		CB	
GIS	CB			CB	
RMU			S		S

S = with switch CB = with circuit breaker

fig. 18: main MV switchgear applications.

	air	oil	SF6	vacuum
MV switch	■ ■ ↘	■ ↘	■ ■ ↗	
MV circuit breaker		■ ↘	■ ■ ■ ↗	■ ■ ↘

fig. 19: MV device breaking techniques, their relative importance and the development of their use.

French and North-American layouts

With these two typical examples it is aimed to show in real terms the various elements that have been set out in this chapter and to highlight the diversity of solutions that exist across the world. Needless to say, other layouts exist, even in these two countries.

The overhead single-line layout used by the EDF (France) (see fig. 20)

This layout applies the following principles:

- at the HV/MV substation, neutral earthing is via an impedance limiting the phase-earth shorting current to 300 A at 20 kV,
- three-phase MV lines, undistributed neutral,
- radial layout (antenna type).

This concept enables detection at MV feeder level of any earthing faults without any other MV protection device downstream of this substation.

The result is protection and control systems that are easy to design, to operate and to modify.

Personal safety is guaranteed.

However, the quality of service that is obtained is only average due to the fact that each MV feeder, at the HV/MV substation, is controlled by one single protection device: when the protection device is tripped, the whole network downstream of this MV feeder is cut off. Solutions exist to make up for this weak point. These days they are based on the use of additional equipment such as remote controlled switches, in the future reclosing circuit breakers will be used in the network.

The overhead single-line layout found in North-America (see fig. 21)

This design is sometimes seen in countries influenced by North-America (e.g. Tunisia). It is based on the following principles:

- maximum MV distribution, by reducing the length of LV feeders in order to reduce losses;
- MV neutral distribution with regular earthing (e.g. every 300 meters);
- three-phase MV lines on main structure, with three-phase, two-phase or one-phase shunting for the MV/LV connections.

This sort of design reduces the costs of lines, the losses and the surges due to faults. However, it requires a very high quality of neutral earthing. In order to obtain a satisfactory degree of personal safety, it is necessary to include numerous MV devices (fuses,

reclosers, sectionalisers, see glossary). However, in certain cases, the protection is limited to cut-out type fuses (see glossary), the financial investment is thus restricted, but to the detriment of performance and safety (risk of fire).

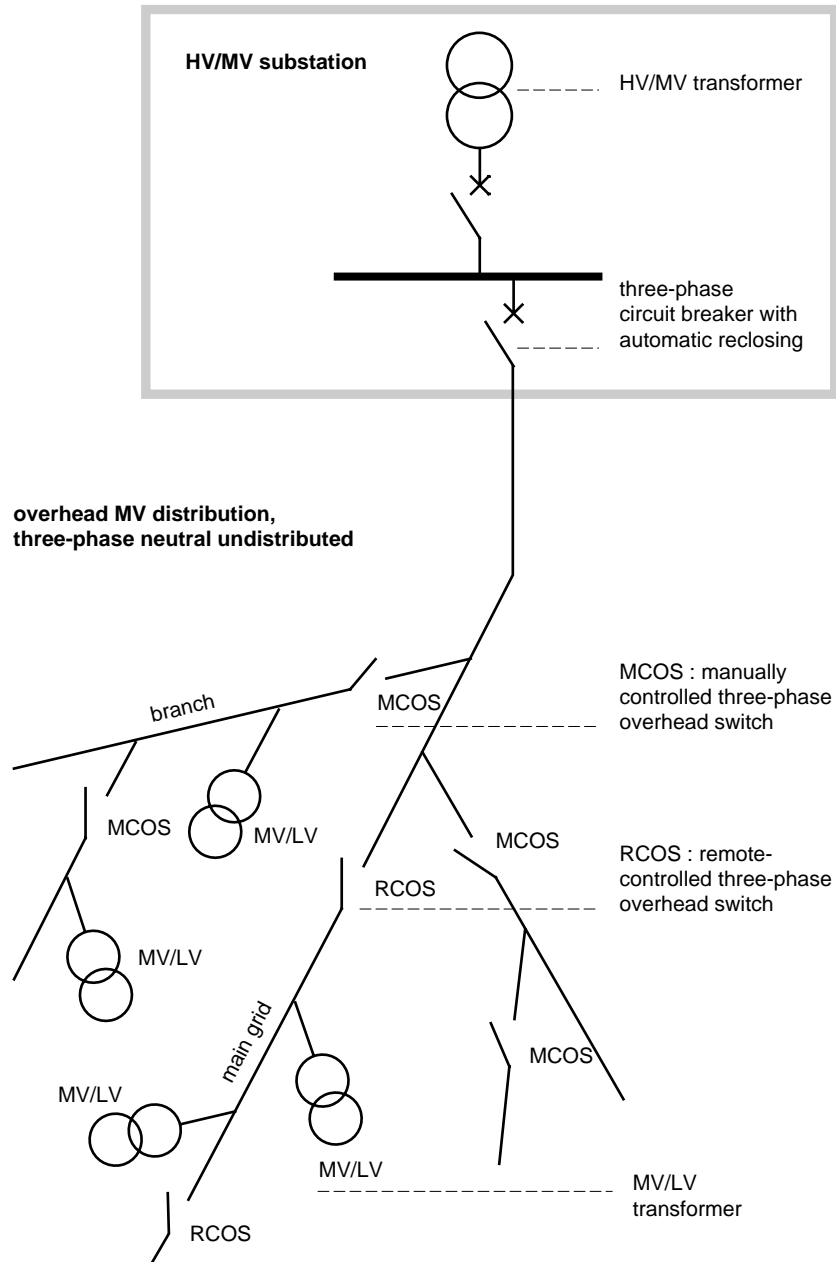

fig. 20: overhead MV distribution layout (EDF - France).

The design of the protection and control systems is complex in terms of the selectivity between the different protection devices.

In addition the operation and maintenance of such networks is more difficult than for that

concerning grid of EDF-type layouts:
 ■ highly trained staff are required (switchgear maintenance, protection device setting,...),
 ■ considerable stocks of spare parts must be held (different rated fuses,...).

This solution is especially justified in

countries spread over a large area and with a low load density (e.g.: United States and Canada in rural areas).

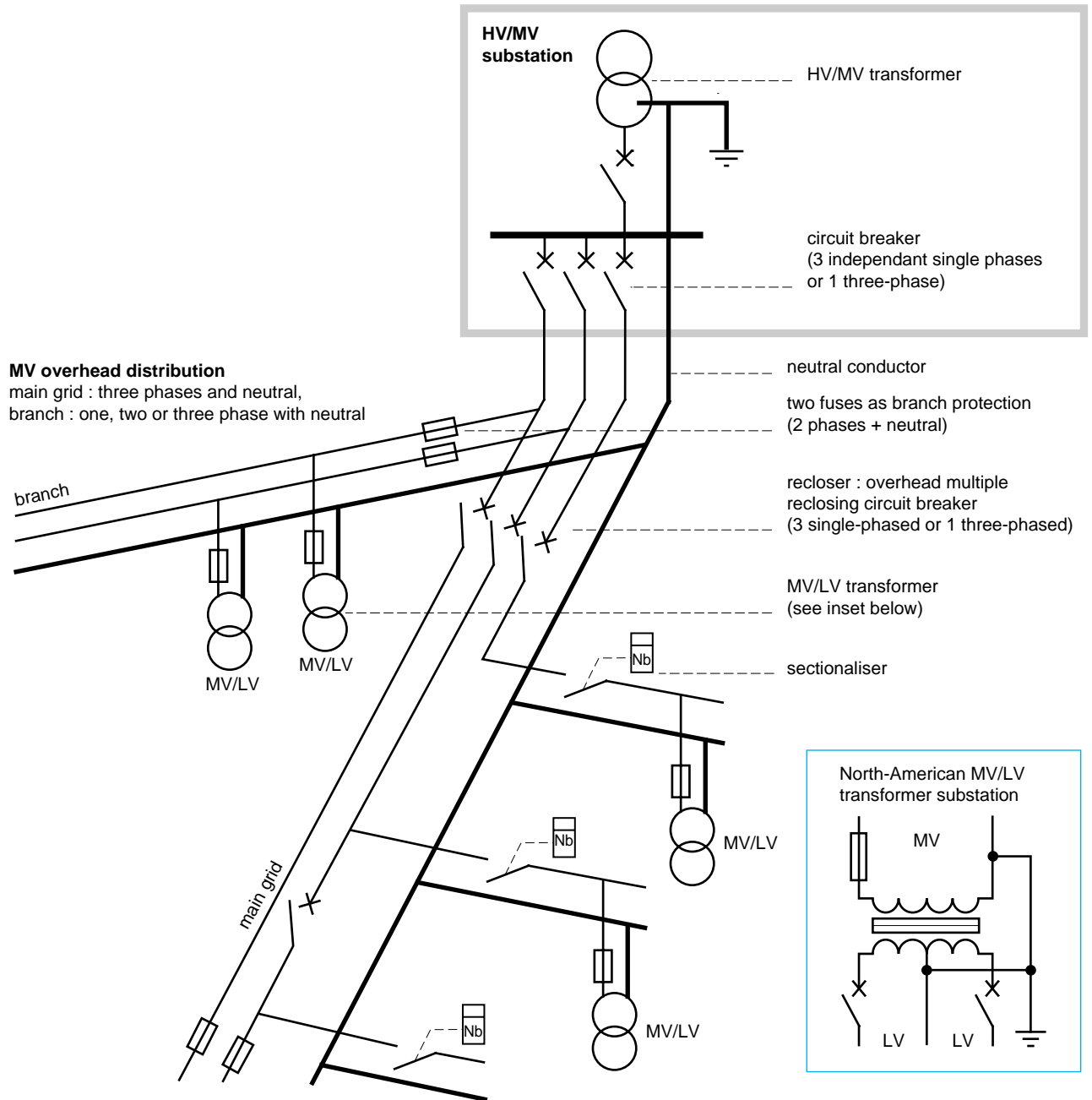

fig. 21: North-American overhead MV distribution layout (each phase shown).

5. protection and control of MV networks

The advent of digital technologies based on microprocessors has greatly modified solutions used in design of protection and control systems. This chapter presents the latest developments and future prospects for these increasingly complex functions that are operated on MV networks. It also shows the importance of a new subject, that being electromagnetic compatibility (EMC).

MV protection device technology

The role of a protection device, or MV relay (see appendix 1), is:

- to continually monitor various parameters for part of the network (line, cable or transformer),
- to act in the case of a fault,
- and increasingly frequently to transmit information for operation of the network.

To this end it analyses the electrical values that are supplied to it by measurement device sensors, and gives operating commands to the switching circuits.

Having been limited to electromagnetic technology, MV protection devices are today undergoing fundamental development with the use of microprocessors.

Thus, the equipment available today is based on three technologies: electromagnetic, analog and digital. The oldest is electromagnetic technology, the relays are simple and specialised (current, voltage, frequency control) but are not very accurate, their settings are liable to change with time.

The more recent electrical analog technology (transistor) has improved precision and reliability.

Lastly in the 1980's, digital technology has, due to the processing power of microprocessors, enabled data processing units to be produced that can:

- generally back-up various protection devices,
- replace the cubicle's relays (automatic control),
- provide electrical parameter measurements to the operator.

These versatile devices are:

- flexible (protection selection is simply programmed),
- parameter-adjustable (wide choice of settings),
- reliable (equipped with self-monitoring or watch-dog devices and self-testing),
- cost saving (their cabling and installation time are reduced).

In addition, due to their powerful algorithms and their digital communication, they enable the performance of additional functions such as logical selectivity.

Using this ability to communicate, a complete network control system is now possible (similar to technical management of an industrial plant).

In terms of sensors, and in particular those of current, there is an increasing trend towards wide measurement band sensors in place of current transformers (1 or 5 A). This sort of sensor, that works on the Rogowski principle (air cored coil), is the type currently on offer. It offers distributors optimised solutions (reduction of variables and ease of choice) and greatly improved performance (greater linearity of the response curve) over traditional current transformers.



fig. 22: SEPAM, protection and control unit and its three Rogowski coil current sensors (Merlin Gerin).

electromagnetic compatibility (EMC)

The electromagnetic compatibility (EMC) is defined as the ability of a device, a piece of equipment or a system to function in a satisfactory manner in its electromagnetic environment, without affecting this environment; this environment possibly containing other more or less sensitive devices.

In order to develop its new products, taking account of the development of digital techniques and the necessary cohabitation of MV equipment (high values of voltage and current, particularly when being switched) and electronic protection and control devices (low voltage level and high sensitivity to electromagnetic radiation), Merlin Gerin has had to increase the scope of and then develop applications in the field of electromagnetic compatibility (EMC). In addition, in order to satisfy the distributors' requirements (operational safety), it has been necessary to carry out more stringent tests than those defined in recent standards that are currently valid (see appendix 1) that define the acceptable interference level.

■ Thus, for measurement devices, the IEC 801-3 standard details tests across a frequency range of 27 MHz - 500 MHz and three levels (1, 3, 10 V/m) whereas test conditions in Merlin Gerin laboratories are considerably more severe: the range of frequencies covered is from 10 kHz to 1 GHz; in addition, from 27 MHz to 1 GHz, devices can be tested in fields of up to 30 V/m. (also see Merlin Gerin "Cahier Technique" n°149)

■ And for MV equipment, certain tests are carried out under real conditions on complete boards (MV switchgear and protection devices).

However, although electromagnetic compatibility (EMC) is taken into account in all development and manufacturing phases of equipment, in order to ensure perfectly operational equipment, it must also be considered during on site cabling and installation phases.

MV control applications

Towards centralized operation

Remote control is the grouping of all that is necessary to control remotely MV network into one or several points (see fig. 23). These points are fixed or mobile (taken in a vehicle) control stations. They are also called, dependant on distributors, control centres, dispatching or SCADA (supervisory control and data acquisition).

To account for the specific needs of MV network control, these control centres are different from those used on transmission and subtransmission

networks. The number and geographical dispersion of the points of remote control, the simultaneous management of several different control centres, the number and level of qualifications of the operators requires adapted solutions:

- ergonomics and user-friendliness of the work stations,
- control assistance tools,
- control centre configuration tools (glossary),
- management of the various transmission systems used.

In practice remote control covers the functions of remote-data transmission, remote supervision, telemetering and

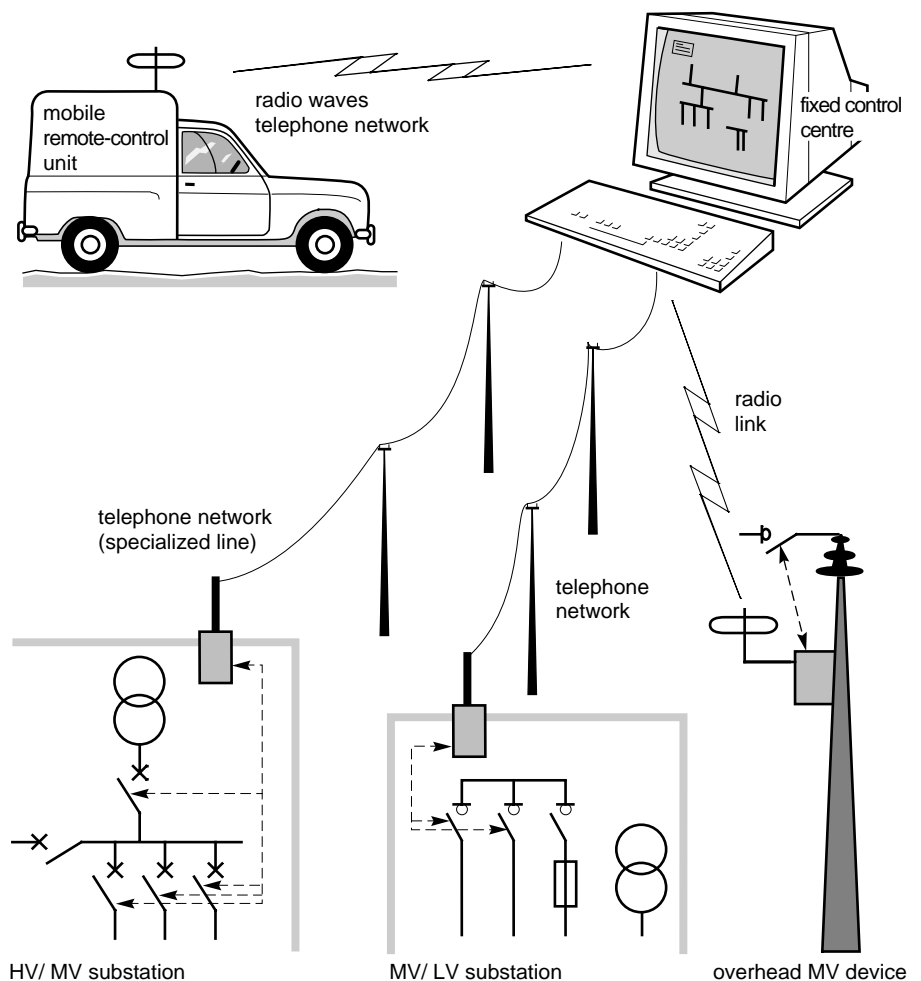
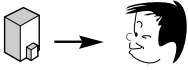

fig. 23: example of remote control of a MV network, with the various links required for information exchange.

remote controlling. These functions can be divided into two groups dependant on the direction of transmission between the operator and the network:

- remote supervision, of devices by the operator,
- remote controlling, by the operator of the devices.

Remote supervision



This in itself groups signals concerning the position of various MV equipment, their possible tripping on fault, instantaneous or weighted measurements from various parts of the electrical network, and any other information indicating the up-to-date status of the network. It enables for example, the automatic and continuous printing, in sequential order, of all the events necessary to

control of the network in real time, or for its analysis at a later date.

All this information together with its display mode, is defined at the design stage of the telecontrol system. In particular, the mimic diagram displays are created as a function of the actual installation and the operators needs. In addition they are displayed in real time. The operator can then visualise:

- the operational layouts (electrical network, substation, MV cubicle);
- installation status (status of MV devices,...);
- values of operational data (currents, voltages, powers,...);
- values of MV protection devices settings;
- details concerning alarms, with their chronology of occurrence;
- ...

Remote controlling

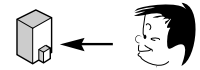

Remote opening and closing of power equipment is a basic example of remote controlling. The practical application is in the form of remotely controlled MV switches and circuit breakers. Other functions can be remote controlled: settings, automatic control,...

There must be a maximum degree of certainty concerning remote control commands. This is obtained using a powerful communications network that allows access to information in real time. Thus a switching command for a MV device is transmitted via a double remote control (TCD), and confirmed by return of a double transmission signal (TSD).

Remote control processes also integrate requests for validation and confirmation before execution of a switching command.

Remote control

In MV distribution this is a cost saving factor in terms of operation of the network. Indeed, without having to travel, the operator can continually monitor and control the operation of his network. As an example: following a fault it is possible to rapidly change the network operating layout so as to minimise the proportion of it that is cut off, this being done by remote consultation of fault position indicators (see glossary) that are installed at different points on the MV network, followed by remote control of MV switches. This results in a considerable reduction in the amount of undistributed energy, but also in network optimization with possibilities of optimum management of the load distribution.

The network loading can also be analysed.

In particular, by logging the load curve verification and optimization of energy consumptions can be performed.

Finally, to increase efficiency, the operator can have rapid access to the most relevant information via an automatic pre-processing method such as a sorting operation, graphical representation operation, calculation operation,....

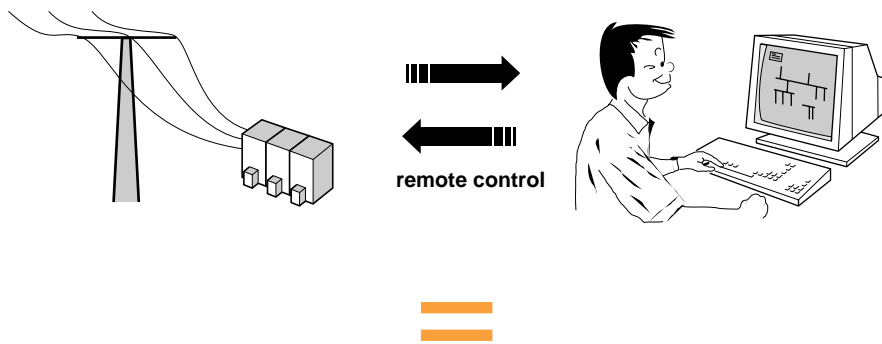

remote supervision (information transmission)

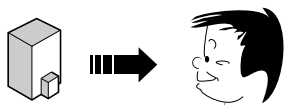

- remote data transmission
- telemetering



remote controlling (command transmission)

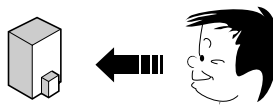

- remote control of network's MV devices
- remote adjustment of settings.

fig. 24: several functions, here grouped according to the direction of transmissions between operator and network, are required for remote control.

Automatic energy supply management

This management, which aims to improve the quality of service via the continuity of supply on the network, has its main application in the permutation of various electrical energy supplies. This application is based on automatic control.

The double shunt type topology, as operated by the EDF on some of its networks, is an example of this.

MV telecontrol architectures

The advent of digital technologies has had a considerable impact on the solutions employed in MV telecontrol. In particular, the ability to use compact and reasonably priced digital protection and control units enables, with centralized operation control, the use today of local intelligent systems. This development offers the following advantages:

- it reduces the disadvantages of intelligent systems concentrated in one single point. Indeed, a fault at this point would be catastrophic for the whole electrical network operation.
- it offers the advantage of a better maintainability and an increased operational flexibility.

Electrical networks, whatever their layout, adapt completely to this development. Thus, in spite of the diversity of operational methods, it is logical that we see development of prioritizing MV control functions. With this aim, a MV control system defines:

- functions to be performed,
- their prioritized level,
- their geographical location.

It can be studied in terms of four levels (see fig. 25):

- level 0: MV devices and sensors,
- level 1: protection and control of an MV cubicle,
- level 2: local control of a substation or installation,
- level 3: remote control of a MV network.

(see EDF application in appendix 3).

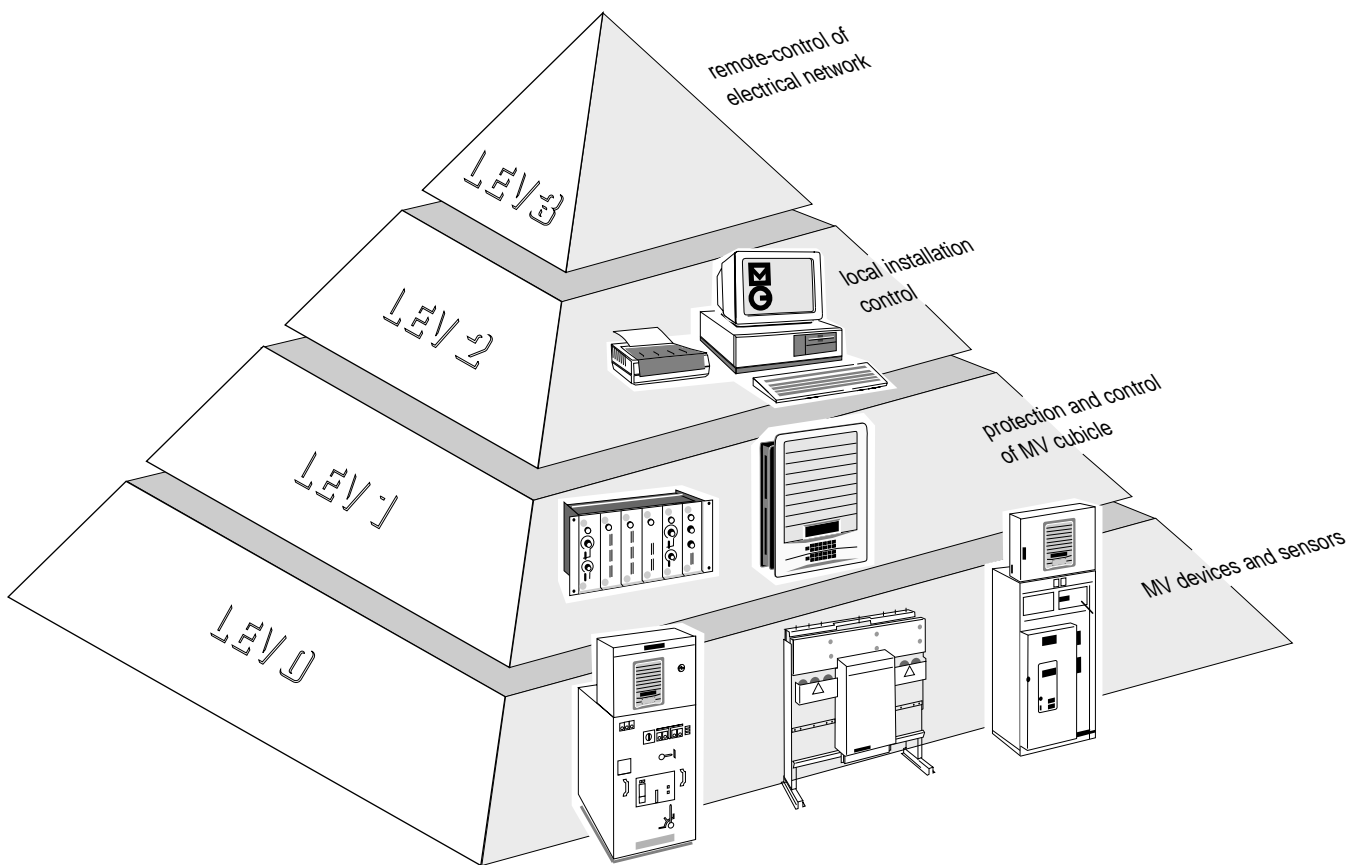

fig. 25: the various priority levels of MV control-command functions

Together this constitutes a MV control architecture, whose operation relies on numerous exchanges of information between the various priority levels. This information is essentially:

- remote data transmission,
- telemetering,
- remote control.

The exchange of such information can be continuous or as events occur (network incident, switching commands,...); it requires high-performance communications networks.

communications networks

All of these exchanges are grouped together within the remote data transmission function, as defined by the following parameters:

- the organization,
- the transmission equipment involved,
- the communication protocol.

All these parameters are such as to ensure that any message transmitted is correctly received (free of errors).

Remote data transmission organization

The simplest solution is to communicate between two transmitters-receivers. However, with links between only two points, the limit of this system's application possibilities is very quickly reached. When several units are involved in telecontrol, a single point-to-point link becomes insufficient, and this is where the idea of multi-point comes in. In this case, two organization types are possible:

- master-master

All the units within this organization can take the initiative to communicate.

- master-slave

The control unit with the highest priority level in the architecture is generally the master. It is responsible for the management of all transmissions, to which end it interrogates all slave units in turn on a continuous basis or following an incident. The slave units respond to the interrogation and execute orders given by the master unit.

In terms of control for electrical networks, the most frequently used and the safest organization is that of master-slave type.

As for data transmission, it is of series type. This means that pieces of binary (0/1) coded information are sent one after the other using the same equipment. Above all the advantages of this type of transmission are simple cabling and good immunity to external disturbances.

Transmission methods

Information transmission requires the use of one or several pieces of equipment.

In the case of control of electrical networks, the method used is:

- paired wires, coaxial cable, (specialized telephone links or national telephone networks)
- radio waves (radio links),
- power cable (power line carrier).

Optic fibre is still in the experimental stage since, in spite of its great advantage of being insensitive to electrical disturbances, its installation cost remains a considerable hurdle to be overcome. As for power line carrier systems, to date they have only been used for network load management, for example sending of signals to change the applied price-rate by the EDF and sending of load shedding commands in the United States. However, they are in the experimental stage for other applications, for example remote electricity-meter reading or reconfiguration of a network following a fault.

In fact, at the moment, no one type of method is predominantly used; the choice depending on various criteria:

- amount of information to be transmitted,
- frequency of exchange (number and periodicity),
- speed required for exchanges,
- type of information,
- transmission distance,
- geographical constraints (e.g. mountain region),
- cost of exchanged information.

In practice, an electrical energy distributor will always use various methods:

- specialized lines (paired wires) for control of important installations (HV/MV substation, MV/MV substation),
- radio-electrical or telephone links for control of secondary installations (remote controlled MV/LV substation and MV pole-mounted switch).

Transmission protocols

Protocol is the language used for information exchange between the various protection and control units within an architecture. It defines the structure of the exchanged messages, both in terms of requests for information and for response messages. These protocols can be unique to one equipment manufacturer (or to several manufacturers) or standardized, conforming to various standards. As far as public distribution is concerned, within the concept of architecture that has been presented above, which is becoming generalized, distributors are trying to standardize protocols between levels 2 and 3. However, internal switchgear transmission protocols remain the choice of the manufacturer.

Communicating in the chosen protocol for an architecture is a condition which a piece of equipment must satisfy if it is to be integrated within that architecture.

6. conclusion

The noticeable feature of current installations, remains their country-dependant diversity:

- diversity in electrical layouts and their protection system,
- diversity in basic technical choices,
- diversity in operating methods.

However, two major long term developments are envisaged by all distributors: development towards a MV system and development towards automatic control of MV networks.

Development towards a MV system

As has been seen in the above pages a MV electrical distribution network, is formed by the overlapping of two networks:

- the energy network, whose objective is to carry energy to user units. It is defined by the single line layout, and is made up of electrotechnical equipment, transformers, cables,...
- the information network, whose objective is to process data to obtain maximum safety and overall availability within this energy network. Defined by protection and control systems, this network is made up of protection and control units, which are interlinked via a high-performance communications network and are distributed:
 - on the MV equipment level,
 - on the substation or installation level,
 - on the electrical network level itself.

Thus, from electrical network design to operation, "Medium Voltage Man" becomes "System Man".

Development towards automatic control of MV networks

Following the agricultural and industrial revolutions, that of communications has irreversibly created new needs and new solutions. The next stage will be the use of expert systems to automatically analyse and operate networks. This development is already undergoing trials by certain distributors, for example TEPCO in Japan.

However, an obstacle to future development is the state of existing networks. Indeed, the latter were not designed with a view to automatic operation: their complex, inconsistent

layouts do not facilitate rational analysis.

Distributors are well aware of this obstacle. Thus, their new long-term objectives involve moving towards simplification and rationalization of network layouts, which requires long-term and costly investment. Without waiting for this future stage, they are continually trying solutions that are adapted to their current MV network layouts.

In the same way, manufacturers use the most recent technologies to benefit distributors.

Of course Man must always remain master of such Systems. And whilst data processing, born from computing, already offers distributors better knowledge and understanding of their electrical networks, future years will bring innovative solutions which will contribute to achieving the main objective: satisfying the requirements of electrical energy consumers with an optimum quality of service.

appendix 1: some MV product standards

The diversity of equipment mentioned in this "Cahier Technique" makes it impossible to give all of their respective standards.

As an example here are a few standards:

- with respect to MV switchgear IEC 56 and 694, IEC 470 for contactors UTE C 64-100 and C 64-101, VDE 0670, BS 5311, ANSI C37-06 for circuit breakers.

- with respect to Ring Main Unit IEC 129,265,298, and 420, UTE C 64-130, C 64-131, and C 64-400, VDE 0670, BS 5227,

- with respect to protection devices IEC 68, IEC 225, IEC 655, NF C 20-455, NF C 63-850.

- with respect to electromagnetic compatibility:
 - in terms of susceptibility to disturbances, IEC 801 - chapters 1 to 4, NF C 46-020 to 023,
 - in terms of disturbance emission EN55 022, NF C 91-022.

appendix 2: various selectivity techniques

general

When a fault occurs on an electrical network, it may be detected simultaneously by several protection devices situated in different areas.

The selectivity of the protection system gives priority of operation to the closest device situated upstream of the fault. Thus, interruption of supply is limited to as small a part of the network as possible..

However, a protection system also allows for contingencies. Thus, when the system is designed, provision is made for the incorrect functioning of a protection device, in which case a different device, situated upstream of the latter, should function to limit the effects of the fault.

Each of these protection devices installed in series on the network represents a selectivity step.

In a MV network, the number of selectivity steps between HV/MV and MV/LV transformers is generally limited to between 3 and 5 depending on the country. Indeed, above this safety can no longer be guaranteed since the reaction time and the fault currents become very dangerous.

the various techniques

To give this selectivity in a MV protection system five main techniques can be used: amperometric, chronometric, differential, distance related and logical.

Amperometric selectivity

This is obtained by adjusting trip threshold current values.

Chronometric selectivity

This is obtained by adjusting trip threshold timing values.

Differential selectivity

This is obtained by dividing the network into independant zones, with detection for each of the zones of any difference in the sum of currents entering the zone and the sum of currents leaving the zone. This technique requires wiring between protection devices situated at the various extremities of the monitored zone.

Distance related selectivity

This is obtained by dividing the network into zones, with the protection devices locating in which zone the fault has occurred by calculating downstream impedances.

Logical selectivity

This selectivity is obtained by means of a "logical stand-by" command emitted by the first protection device situated just upstream of the fault which should break the circuit, transmitted to other protection devices situated further upstream. It enables the number of selectivity steps to be increased without increasing the upstream trip time. Pilot wires are required between protection units. This technique, developed by Merlin Gerin, is detailed in "Cahier Technique" n° 2.

appendix 3: EDF architecture and Merlin Gerin equipment

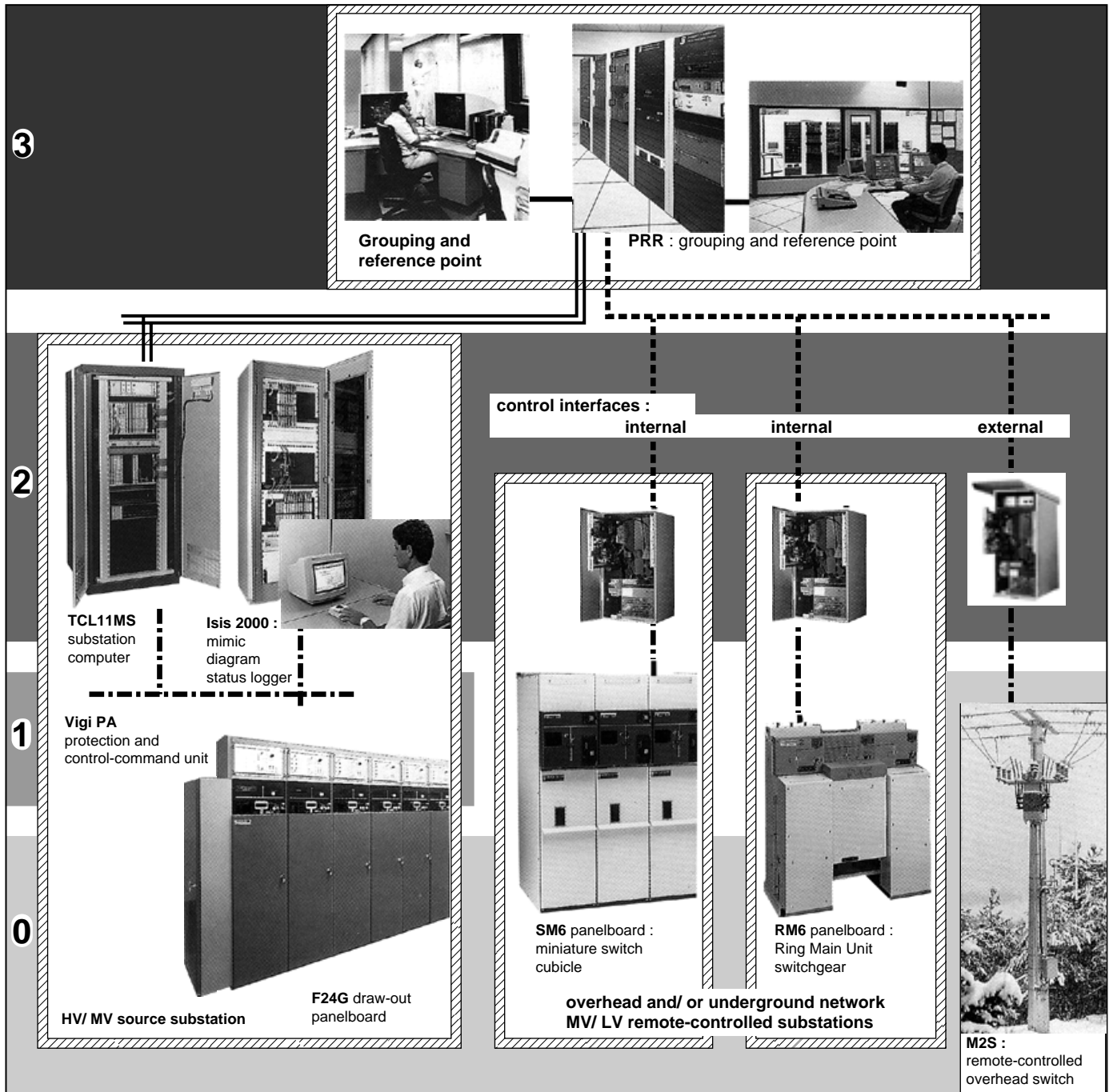

- level 3: network remote control
- level 2: local control of an installation
- level 1: protection and control-command of a MV cubicle
- level 0: MV devices and sensors

Communications networks:

- remote transmission via specialised telephone lines
- remote transmissions by radio and/ or telephone networks
- internal switchgear network (currently line to line)

appendix 4: references

Merlin Gerin "Cahiers Techniques"

- Network protection using the Logical Selectivity System

"Cahier Technique" n°2 (F. Sautriau)

- EMC: Electromagnetic Compatibility

"Cahier Technique" n°149 (F. Vaillant)

Various publications

Numerous documents cover certain themes touched on in this "Cahier Technique". However, whilst less of them cover all of the themes, we have considered it of more use to indicate to the reader organizations that distribute technical reports written for various congresses:

- "journées d'étude technique S.E.E."
Société des Electriciens et des
Electroniciens (= Society of Electricians
and Electronics Specialists)

□ quality and cost saving for electrical supply,

□ Medium Voltage rural networks: developments and future prospects.

Address:

Société des Electriciens et des
Electroniciens

48, Rue de la Procession
75724 PARIS Cedex 15

- C.I.R.E.D.

Congrès International des Réseaux
Electriques de Distribution

(= International Congress on Electrical
Distribution Networks).

Address:

Institution of Electrical Engineers,

Savoy Place,

London WC2R 0BL

United Kingdom.

- UNIPEDE

Union Internationale des Producteurs et
Distributeur d'Electricité.

(= International Union of Electricity
Producers and Distributors).

Address:

39 avenue Friedland

75008 PARIS