

Cahier technique no. 205

Power supply of lighting circuits

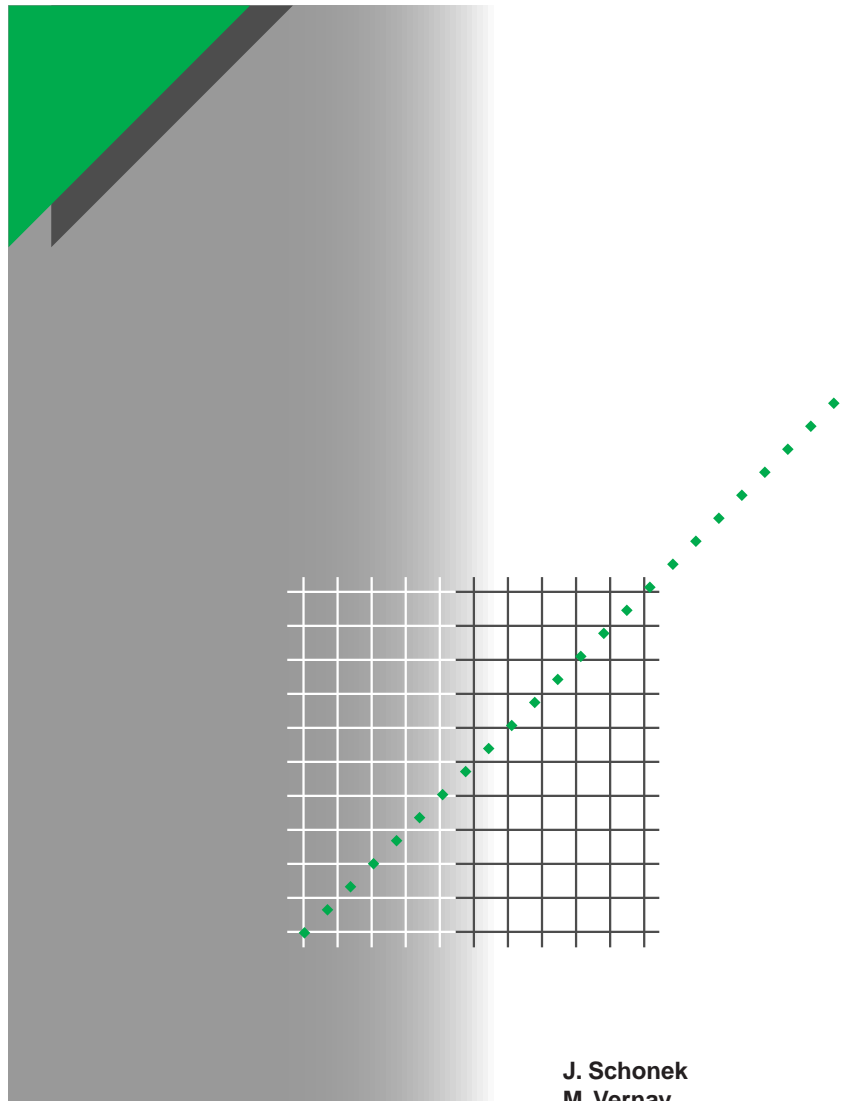

Merlin Gerin

Modicon

Square D

Telemecanique

J. Schonek
M. Vernay

"Cahiers Techniques" is a collection of documents intended for engineers and technicians, people in the industry who are looking for more in-depth information in order to complement that given in product catalogues.

Furthermore, these "Cahiers Techniques" are often considered as helpful "tools" for training courses.

They provide knowledge on new technical and technological developments in the electrotechnical field and electronics. They also provide better understanding of various phenomena observed in electrical installations, systems and equipments.

Each "Cahier Technique" provides an in-depth study of a precise subject in the fields of electrical networks, protection devices, monitoring and control and industrial automation systems.

The latest publications can be downloaded from the Schneider Electric internet web site.

Code: <http://www.schneider-electric.com>

Section: **Experts' place**

Please contact your Schneider Electric representative if you want either a "Cahier Technique" or the list of available titles.

The "Cahiers Techniques" collection is part of the Schneider Electric's "Collection technique".

Foreword

The author disclaims all responsibility subsequent to incorrect use of information or diagrams reproduced in this document, and cannot be held responsible for any errors or oversights, or for the consequences of using information and diagrams contained in this document.

Reproduction of all or part of a "Cahier Technique" is authorised with the prior consent of the Scientific and Technical Division. The statement "Extracted from Schneider Electric "Cahier Technique" no." (please specify) is compulsory.

no. 205

Power supply of lighting circuits



Jacques SCHONEK

Graduate engineer from ENSEEIHT (Ecole Nationale Supérieure d'Electrotechnique, d'Electronique, d'Informatique, d'Hydraulique et des Télécommunications) with a doctorate in Engineering from the University of Toulouse, he was involved in designing variable speed drives for the Telemecanique brand from 1980 to 1995. He then became manager of the Harmonic Filtering group. He is currently responsible for Electrotechnical Applications and Networks in the Advanced Design Office of Schneider Electric's electrical distribution division.



Marc VERNAY

Graduate engineer from CNAM (Conservatoire National des Arts et Métiers) in Grenoble, he worked for Merlin Gerin from 1991 to 1996 and was responsible for the "lighting dimmer control" project, after which he provided technical support for lighting applications. He is currently responsible for the Electronic Roadmap for Low Voltage applications in Schneider Electric's electrical distribution division.

Lexicon

Color rendering index - CRI -

Number designated by CRI or Ra which characterizes the capacity of a light source to accurately restore the various colors in the visible spectrum of a lit object, without loss or coloration.

The International Commission on Illumination (C.I.E., Commission Internationale de l'Eclairage) has defined a general color rendering index Ra, where the maximum value is 100.

Converter

Device designed to modify at least one characteristic of the electrical energy (voltage, magnitude, frequency).

Dimmer switch

Converter designed to vary the magnitude of an AC voltage via an electronic switch whose conduction time is limited to a fraction of the period of this voltage.

“Electric arc” and “Luminescent discharge”

An electric arc is a gas conduction in which the charge carriers are electrons produced by a primary emission (released by the cathode).

A luminescent discharge is a gas conduction in which the load carriers are electrons produced by a secondary emission (released by the atoms of gas in which the discharge occurs).

“Fluorescent” tube and “neon” tube

A “fluorescent” tube is a lamp consisting of a bulb coated on the inside with a layer of a luminescent substance containing a gas (mercury vapor); the light it diffuses is emitted by the luminescent layer sensitized by the UV radiation from an electrical discharge.

A “neon tube” is a lamp consisting of a bulb in which the light is produced by an electrical discharge passing through the gas (neon argon mixture: 75/25) it contains.

The different colors of these tubes, used for illuminated signs, are obtained by powder deposits inside the bulbs or by using tinted glass throughout.

Interference-suppressing capacitor

Low-value capacitor (several nF) placed on the power supply circuit terminals of electronic devices, designed to protect them from high-frequency disturbance carried by the line supply.

K (Kelvin unit)

Unit of color temperature, this characterizes the apparent color of a light. This value is not representative of the actual temperature of the source of this light.

Luminaire

Device which distributes, filters or transforms the light from one or more lamps. Excluding lamps, it contains the fixings, the auxiliary circuits (starter and ballast) and the connection elements to the power supply circuit.

Luminous efficiency (lm/W)

Quotient of the luminous flux by the power consumed for its emission.

Smoothing capacitor

Capacitor usually placed at the output of a rectifier circuit and designed to reduce the DC voltage ripple.

Power supply of lighting circuits

A source of comfort and productivity, lighting represents 15% of the quantity of electricity consumed in industry and 40% in buildings. The quality of the lighting (light stability and continuity of service) depends on the quality of the electrical energy thus consumed. The supply of electrical power to lighting networks has therefore assumed great importance.

To help with their design and simplify the selection of appropriate protection devices, the authors present in this document an analysis of the different lamp technologies and the main technological developments in progress. After summarizing the distinguishing features of lighting circuits and their impact on control and protection devices, they discuss the options concerning which equipment to use.

Contents

1 The different lamp technologies	1.1 Artificial light	p. 4
	1.2 Incandescent lamps	p. 4
	1.3 Fluorescent lamps	p. 5
	1.4 Discharge lamps	p. 6
	1.5 LEDs (Light Emitting Diodes)	p. 6
	1.6 Lamps for special applications	p. 7
2 Power supply of incandescent lamps	2.1 Lamps with direct power supply	p. 8
	2.2 Extra low voltage halogen lamps	p. 9
3 Power supply of luminaires with magnetic ballasts	3.1 The magnetic ballast	p. 10
	3.2 The starter	p. 10
	3.3 Compensation	p. 10
	3.4 A technological development	p. 12
4 Power supply of luminaires with electronic ballasts	4.1 Principle and characteristics	p. 13
	4.2 Layout	p. 13
	4.3 Constraints	p. 14
5 Technical characteristics and usage of lighting devices	5.1 Main technical characteristics	p. 16
	5.2 Fields of application, advantages and disadvantages	p. 16
	5.3 The different power supply modes	p. 17
6 Difficulties and recommendations	6.1 Constraints related to lighting devices and recommendations	p. 18
	6.2 Sensitivity of lighting devices to line voltage disturbances	p. 20
	6.3 Choice of light dimmers	p. 21
7 Conclusions: technological developments and professional requirements	7.1 Developments in luminaires	p. 22
	7.2 Developments in control and protection equipment	p. 22
	7.3 The necessity for suitable equipment	p. 22
Bibliography		p. 23

1 The different lamp technologies

1.1 Artificial light

Artificial luminous radiation can be produced from electrical energy according to two principles: incandescence and electroluminescence.

Incandescence

This is the production of light via temperature elevation. The energy levels are plentiful, and in consequence, the emitted radiation spectrum is continuous. The most common example is a filament heated to white state by the circulation of an electrical current. The energy supplied is transformed into the Joule effect and into luminous flux.

Luminescence

This is the phenomenon of emission by a material of visible or almost visible luminous radiation.

■ Electroluminescence of gases

A gas (or vapors) subjected to an electrical discharge emits luminous radiation.

Since this gas does not conduct at ordinary temperature and pressure, the discharge is produced by generating charged particles which permit ionization of the gas. The spectrum, in the form of stripes, depends on the energy levels specific to the gas or vapor used. The pressure and temperature of the gas determine the length of the emitted rays and the nature of the spectrum.

■ Photoluminescence

This is the luminescence of a material exposed to visible or almost visible radiation (ultraviolet, infrared).

When the substance absorbs ultraviolet radiation and emits visible radiation which stops a short time after energization, this is fluorescence. Not all the photons received are transformed into emitted photons. The best efficiency rating for existing fluorescent materials is 0.9.

When the light emission persists after energization has stopped, it is phosphorescence.

1.2 Incandescent lamps

Incandescent lamps are historically the oldest (patented by Thomas Edison in 1879) and the most commonly found in common use.

They are based on the principle of a filament rendered incandescent in a vacuum or neutral atmosphere which prevents combustion.

A distinction is made between:

■ Standard bulbs

These contain a tungsten filament and are filled with an inert gas (nitrogen and argon or krypton).

■ Halogen bulbs

These also contain a tungsten filament, but are filled with a halogen compound (iodine, bromine or fluorine) and an inert gas (krypton or xenon). This halogen compound is responsible for the

phenomenon of filament regeneration, which increases the service life of the lamps and avoids them blackening. It also enables a higher filament temperature and therefore greater luminosity in smaller-size bulbs.

The main disadvantage of incandescent lamps is their significant heat dissipation, resulting in poor light output. But, they have the advantage of a good Color Rendering Index (CRI) due to the fact that their emission spectrum is fairly similar to the eye's reception spectrum (see [fig. 1](#)).

Their service life is approximately 1,000 hours for standard bulbs, 2,000 to 4,000 for halogen bulbs. Note that the service life is reduced by 50% when the supply voltage is increased by 5%.

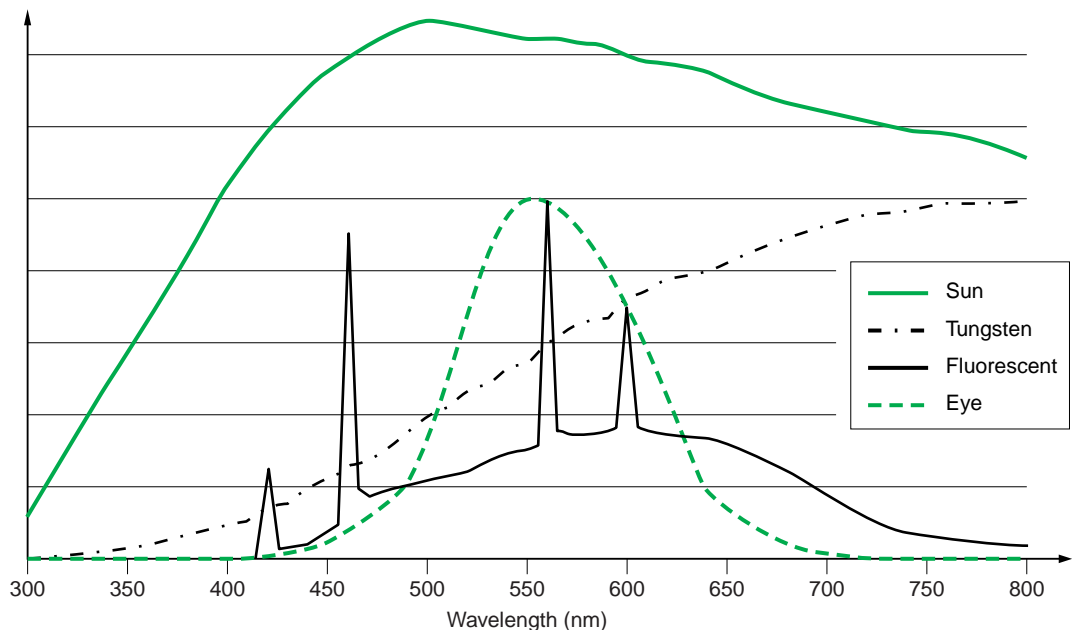

Fig. 1 : eye response curve and emission spectra from different sources of visible light.
Note: the spectrum of fluorescent sources differs according to the lamp model.

1.3 Fluorescent lamps

This family covers fluorescent tubes and compact fluorescent lamps. Their technology is usually known as “low-pressure mercury”.

Fluorescent tubes

These were first introduced in 1938. In these tubes, an electrical discharge causes electrons to collide with ions of mercury vapor, resulting in ultraviolet radiation due to energization of the mercury atoms. The fluorescent material, which covers the inside of the tubes, then transforms this radiation into visible light.

This technology has the disadvantage of a mediocre CRI due to the fact that the emission spectrum is discontinuous. However, nowadays there are different product families which meet

the many needs of CRI, for example so-called “daylight” tubes.

Fluorescent tubes dissipate less heat and have a longer service life than incandescent lamps, but they do need an ignition device called a “starter” and a device to limit the current in the arc after ignition. This last device called “ballast” is usually a choke placed in series with the arc. The constraints affecting this ballast are detailed in the rest of the document.

Compact fluorescent lamps

These are based on the same principle as a fluorescent tube. The starter and ballast functions are provided by an electronic circuit (integrated in the lamp) which enables the use of smaller tubes folded back on themselves.

Compact fluorescent lamps were developed to replace incandescent lamps: they offer significant energy savings (15 W against 75 W for the same level of brightness) and an increased service life (8,000 hrs on average and up to 20,000 hrs for some).

Standard compact fluorescent lamps take a little longer to ignite and their service life is reduced according to the number of times they are switched on. So, if the ignition frequency is multiplied by 3, the service life is reduced by a ratio of 2.

Lamps known as “induction” type or “without electrodes” (see **fig. 2**) start instantaneously and the number of switching operations does not affect their service life. They operate on the principle of ionization of the gas present in the

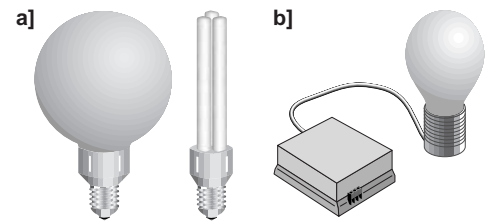

Fig. 2 : compact fluorescent lamps: **a)** standard; **b)** induction.

tube by a very high frequency electromagnetic field (up to 1 GHz). Their service life can be as long as 100,000 hrs.

1.4 Discharge lamps

The light is produced by an electrical discharge created between two electrodes within a gas in a quartz bulb. All these lamps (see **fig. 3**) therefore require a ballast to limit the current in the arc.

The emission spectrum and the CRI depend on the composition of the gas and improve as the pressure increases. A number of technologies have therefore been developed for different applications.

Low-pressure sodium vapor lamps

These have the best light output, however the color rendering is very poor since they only have monochromatic radiation, which is orange in color. Applications: tunnel, motorway lighting.

High-pressure sodium vapor lamps

These produce a white light with an orange tinge. Applications: street lighting, monuments.

High-pressure mercury vapor lamps

The discharge is produced in a quartz or ceramic bulb at pressures of more than 100 kPa. These lamps are called “fluorescent mercury discharge

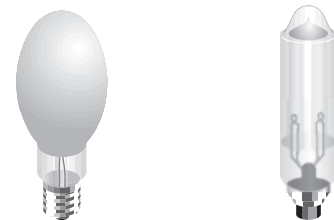

Fig. 3 : discharge lamps.

lamps”. They produce a characteristically bluish white light.

Applications: car parks, supermarkets, warehouses.

Metal halide lamps

The latest technology. They produce a color with a broad spectrum.

The use of a ceramic tube offers better luminous efficiency and better color stability.

Applications: stadia, retail premises, projectors.

1.5 LEDs (Light Emitting Diodes)

The principle of light emitting diodes is the emission of light by a semi-conductor as an electrical current passes through it. LEDs are commonly found in numerous applications, but the recent development of white or blue diodes with a high light output opens new perspectives, especially for signaling (traffic lights, exit signs or emergency lighting).

The average current in a LED is 20 mA, the voltage drop being between 1.7 and 4.6 V depending on the color. These characteristics are therefore suitable for an extra low voltage

power supply, especially using batteries.

A converter is required for a line power supply.

The advantage of LEDs is their low energy consumption. As a result, they operate at a very low temperature, giving them a very long service life. Conversely, a simple diode has a weak light intensity. A high-power lighting installation therefore requires connection of a large number of units in series.

These diodes are used particularly where there is little power available.

1.6 Lamps for special applications

The types of lamp mentioned in this sub-section only have, with the exception of the last two, a single application. Their electrical power supply should always be designed according to the special technical information provided by their manufacturers.

Special incandescent lamps for 3-color traffic lights.

Their service life is increased and their special mounting helps them resist vibrations.

Special mercury vapor lamps

These produce a uniform beam of blue-white light designed for reproduction graphics, screen-printing or jewelers' decorative lighting.

Lamps producing white light with a radiation around 655 nm

These are designed to accelerate photosynthesis in plants. Applications include florists' shops, entrance halls, industrial greenhouses.

Germicidal lamps

These produce ultraviolet in the 253.7 nm wave length. Applications include purification, sterilization of air, water and instruments in the pharmaceutical industry, hospitals, treatment plants or laboratories. These lamps produce radiation that is dangerous to the eyes and skin.

UVA lamps

These are used for tanning and light therapy.

Black light lamps

These generate ultraviolet emission in the long wavelengths which has the effect of activating fluorescent pigments. Applications include finding defects in industry or counterfeit items (notes, pictures, etc) as well as use in show business.

Special halogen lamps

Used for projection of images (slide viewer, overhead projection, microfiche reading), their heat radiation onto the film is reduced by 60% compared to a conventional lamp.

Lamps adapted to projection in film studios and theaters

Their color temperature is 3200° K. Their power rating can be as high as 5000 W. These lamps have better luminous efficiency and more luminous flux but a reduced service life (12 hrs, 100 hrs, 500 hrs).

Heating lamps

These generate a short infrared heat energy beam. Certain types are designed for farming, others for drying and curing paintings, heating in industrial processes or zone heating by radiation.

2 Power supply of incandescent lamps

2.1 Lamps with direct power supply

Constraints

Due to the very high temperature of the filament during operation (up to 2500° C), its resistance varies greatly depending on whether the lamp is on or off. As the cold resistance is low, a current peak occurs on ignition that can reach 10 to 15 times the nominal current for a few milliseconds or even several milliseconds.

This constraint affects both ordinary lamps and halogen lamps: it imposes a reduction in the maximum number of lamps that can be powered by a device such as remote-control switch, modular contactor or relay for busbar trunking.

Varying the brightness

This can be obtained by varying the voltage applied to the lamp.

This voltage variation is usually performed by a device such as a triac dimmer switch, by varying its firing angle in the line voltage period. The wave form of the voltage applied to the lamp is illustrated in **figure 4a**. This technique known as “cut-on control” is suitable for supplying power to resistive or inductive circuits. Another technique suitable for supplying power to capacitive circuits has been developed with

MOS or IGBT electronic components. This technique varies the voltage by blocking the current before the end of the half-period (see **fig. 4b**) and is known as “cut-off control”.

The latest devices use both these techniques while adapting automatically to the nature of their load.

Switching on the lamp gradually can also reduce, or even eliminate, the current peak on ignition.

Note that light dimming:

- is accompanied by a modification in the color temperature;

- has an adverse effect on the service life of halogen lamps when a low voltage is maintained for a long time. Indeed, the filament regeneration phenomenon is less effective with a lower filament temperature.

Another technique is used for timer switch-off warnings. These devices warn that the lighting will shortly be switched off by reducing the luminous intensity by 50% for a several seconds. This reduced brightness is obtained by applying a voltage half-wave, positive or negative, to the lamps at intervals of one second, using a triac device.

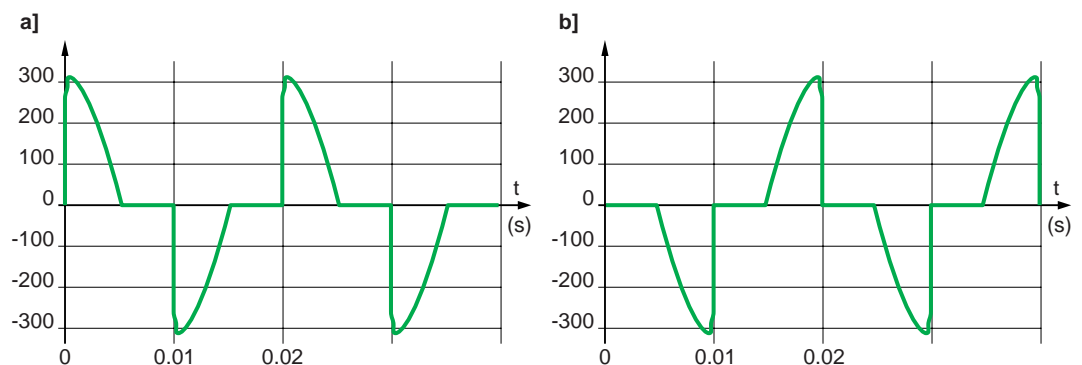

Fig. 4 : shape of the voltage supplied by a light dimmer at 50% of maximum voltage with the following techniques:
a] “cut-on control”,
b] “cut-off control”.

2.2 Extra low voltage halogen lamps

Constraints

Some low-power halogen lamps are supplied with ELV 12 or 24 V, via a transformer or an electronic converter.

- With a transformer, the magnetization phenomenon combines with the filament resistance variation phenomenon at switch-on. The inrush current can reach 50 to 75 times the nominal current for a few milliseconds. The use of dimmer switches placed upstream significantly reduces this constraint.

- Electronic converters, with the same power rating, are more expensive than solutions with a transformer. This commercial handicap is compensated by a greater ease of installation since their low heat dissipation means they can be fixed on a flammable support. Moreover, they usually have built-in thermal protection.

These devices can therefore be marked (IEC 60417 – 1st October 2000):

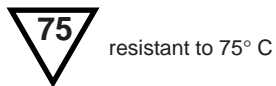

Varying the brightness

There are a variety of possible technical solutions:

- dimmer switch and transformer,
- electronic converter controlled by a 0-10 V external signal,
- dimmer switch and converter; this solution is used to control the brightness of several lamps with a single dimmer switch, but it is important to check carefully that the dimmer switch and converters are compatible.

Developments

New ELV halogen lamps are now available with a transformer integrated in their base. They can be supplied directly from the LV line supply and can replace normal incandescent lamps without any special adaptation.

3 Power supply of luminaires with magnetic ballasts

3.1 The magnetic ballast

Fluorescent tubes and discharge lamps require the intensity of the arc to be limited, and this function is fulfilled by a choke (or magnetic ballast) placed in series with the bulb itself (see **fig. 5**).

This arrangement is most commonly used in domestic applications with a limited number of tubes. No particular constraint applies to the switches.

Dimmer switches are not compatible with magnetic ballasts: the cancellation of the voltage for a fraction of the period interrupts the discharge and totally extinguishes the lamp.

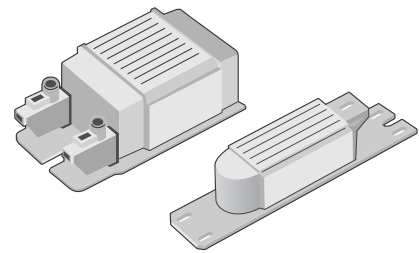

Fig. 5 : magnetic ballasts.

3.2 The starter

The starter has a dual function: preheating the tube electrodes, and then generating an overvoltage to ignite the tube. This overvoltage is generated by the opening of a contact (controlled by a thermal switch) which interrupts

the current circulating in the magnetic ballast. During operation of the starter (approx. 1 s), the current drawn by the luminaire is approximately twice the nominal current.

3.3 Compensation

Since the current drawn by the tube and ballast assembly is essentially inductive, the power factor is very low (on average between 0.4 and 0.5). In installations consisting of a large number of tubes, it is necessary to provide compensation to improve the power factor.

Possible layouts

For large lighting installations, centralized compensation with capacitor banks is a possible solution, but more often this compensation is included at the level of each luminaire in a variety of different layouts (see **fig. 6**).

The compensation capacitors are therefore sized so that the global power factor is greater than 0.85. In the most common case, that of parallel compensation, its capacity is on average 1 μF for 10 W of active power, for any type of lamp. However, this compensation is incompatible with dimmer switches.

Constraints affecting compensation

The layout for parallel compensation creates constraints on ignition of the lamp. Since the

capacitor is initially discharged, switch-on produces an overcurrent. An overvoltage also appears, due to the oscillations in the circuit made up of the capacitor and the power supply inductance.

The following example can be used to determine the orders of magnitude.

■ Assuming an assembly of 50 fluorescent tubes of 36 W each:

- total active power: 1800 W,
- apparent power: 2 kVA,
- total rms current: 9 A,
- peak current: 13 A.

■ With:

- a total capacity: $C = 175 \mu\text{F}$,
- a line inductance (corresponding to a short-circuit current of 5 kA): $L = 150 \mu\text{H}$.

The maximum peak current at switch-on equals:

$$I_c = V_{\max} \sqrt{\frac{C}{L}} = 230 \sqrt{2} \sqrt{\frac{175 \cdot 10^{-6}}{150 \cdot 10^{-6}}} = 350 \text{ A}$$

The theoretical peak current at switch-on can therefore reach **27 times** the peak current during normal operation.

The shape of the voltage and current at ignition is given in **figure 7** for switch closing at the line supply voltage peak. There is therefore a risk of contact welding in electromechanical control devices (remote-

control switch, contactor, circuit-breaker) or destruction of solid state switches with semi-conductors. In reality, the constraints are usually less severe, due to the impedance of the cables.

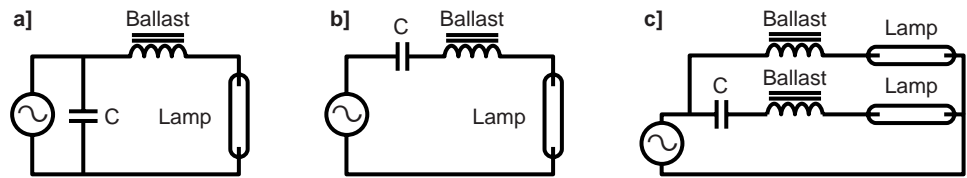

Compensation layout	Application	Comments
Without compensation	Domestic	Single connection
Parallel [a]	Offices, workshops, superstores	Risk of overcurrents for control devices
Series [b]		Choose capacitors with high operating voltage (450 to 480 V)
Duo [c]		Avoids flicker

Fig. 6 : the various compensation layouts: **a]** parallel; **b]** series; **c]** dual series also called “duo” and their fields of application.

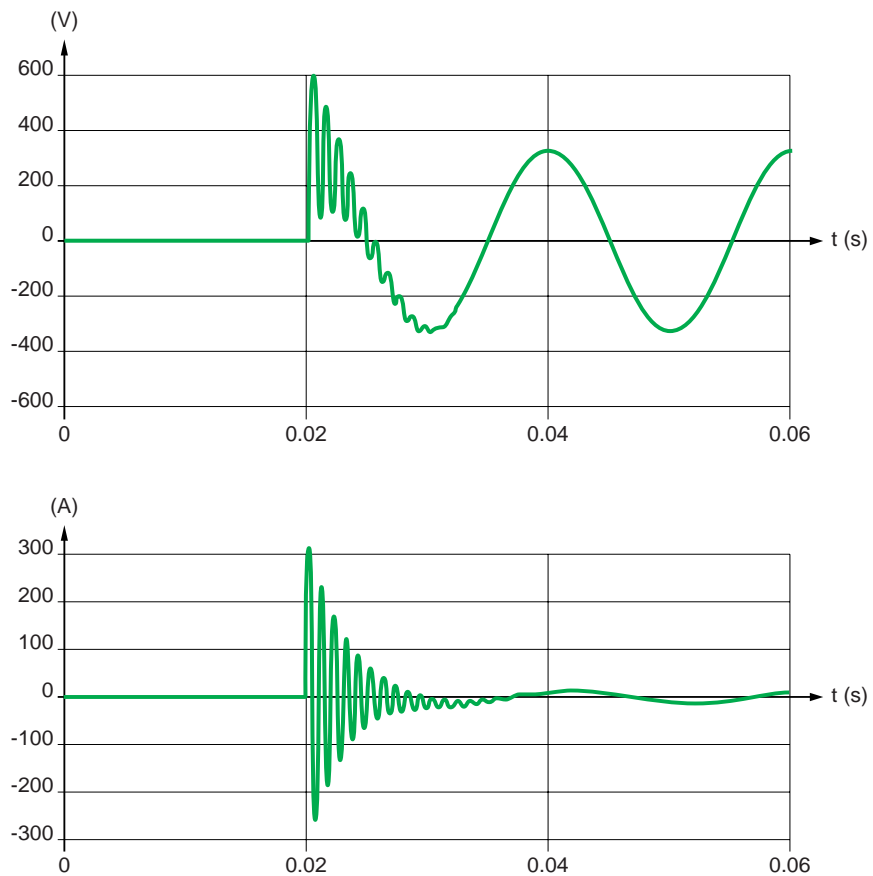

Fig. 7 : power supply voltage at switch-on and inrush current.

Standard IEC 60669–1 (switches for household and similar fixed-electrical installations, general requirements) specifies the capacities to be taken into account when designing switches (for a prospective short-circuit current I_{sc} of 3 kA):

- rating < 6 A: 70 μ F,
- rating \geq 6 A: 140 μ F.

Specific constraint to ignite several groups of fluorescent tubes

When a group of tubes is already switched on, the compensation capacitors in these tubes which are already energized participate in the inrush current at the moment of ignition of a

second group of tubes: they “amplify” the current peak in the control switch at the moment of ignition of the second group.

The table in **figure 8**, resulting from measurements, specifies the magnitude of the first current peak, for different values of prospective short-circuit current I_{sc} . It is seen that the current peak can be multiplied by 2 or 3, depending on the number of tubes already in use at the moment of connection of the last group of tubes.

Nonetheless, we recommend sequential ignition of each group of tubes so as to reduce the current peak in the main switch.

Number of tubes already in use	Number of tubes connected (second group)	Inrush current peak (A)		
		$I_{sc} = 1500 \text{ A}$	$I_{sc} = 3000 \text{ A}$	$I_{sc} = 6000 \text{ A}$
0	14	233	250	320
14	14	558	556	575
28	14	608	607	624
42	14	618	616	632

Fig. 8 : magnitude of the current peak in the control switch of the moment of ignition of a second group of tubes.

3.4 A technological development

The most recent magnetic ballasts are known as “low-loss”. Their magnetic circuit has been optimized, but the operating principle remains the same. This new generation of ballasts is coming into widespread use, under the influence of new regulations (European Directive, Energy Policy Act - USA).

4 Power supply of luminaires with electronic ballasts

Electronic ballasts are used as a replacement for magnetic ballasts to supply power to fluorescent tubes (including compact fluorescent lamps) and discharge lamps. They also provide the “starter”

function and do not need any compensation capacitor. They were first introduced in the middle of the 1980s.

4.1 Principle and characteristics

The principle of the electronic ballast (see **fig. 9**) consists of supplying the lamp arc via an electronic device that generates a rectangular form AC voltage.

A distinction is made between low-frequency or hybrid devices, with a frequency between 50 and 500 Hz, and high-frequency devices with a frequency between 20 and 60 kHz.

Supplying the arc with a high-frequency voltage can totally eliminate the flicker phenomenon and strobe effects. The electronic ballast is totally silent.

During the preheating period of a discharge lamp, this ballast supplies the lamp with increasing voltage, imposing an almost constant current. In steady state, it regulates the voltage applied to the lamp independently of any fluctuations in the line voltage.

Since the arc is supplied in optimum voltage conditions, this results in energy savings of 5 to 10% and increased lamp service life. Moreover,

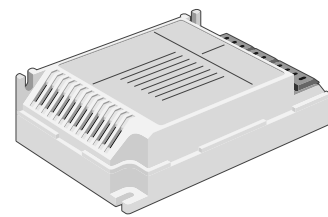

Fig. 9 : electronic ballast.

the efficiency of the electronic ballast can exceed 93%, whereas the average efficiency of a magnetic device is only 85%. The power factor is high (> 0.9).

The electronic ballast is also used to provide the light dimming function. Varying the frequency in fact varies the current magnitude in the arc and hence the luminous intensity.

4.2 Layout

An electronic ballast essentially consists of a rectifier stage (with Power Factor Correction - PFC - if necessary), a smoothing capacitor for

the rectified voltage, and a half-bridge inverter stage (see **fig. 10**). It can also be supplied with direct current.

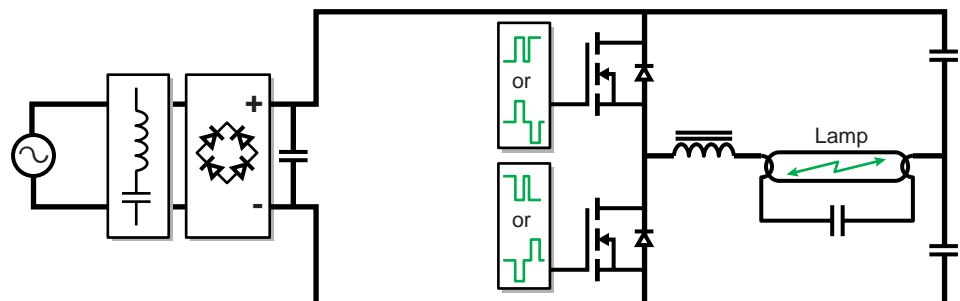

Fig. 10 : simplified schematic of a lamp supplied by an electronic ballast.

4.3 Constraints

Inrush current

The main constraint that electronic ballasts bring to line supplies is the high inrush current on switch-on linked to the initial load of the smoothing capacitors (see **fig. 11**).

Technology	Max. inrush current	Duration
Rectifier with PFC	30 to 100 In	≤ 1 ms
Rectifier with choke	10 to 30 In	≤ 5 ms
Magnetic ballast	≤ 13 In	5 to 10 ms

Fig. 11 : orders of magnitude of the inrush current maximum values, depending on the technologies used.

In reality, due to the wiring impedances, the inrush current for an assembly of lamps is much lower than these values, in the order of 5 to 10 In for less than 5 ms.

Unlike magnetic ballasts, this inrush current is not accompanied by an overvoltage.

Harmonic currents

For ballasts associated with high-power discharge lamps, the current drawn from the line supply has a low total harmonic distortion (< 20% in general and < 10% for the most sophisticated devices). Conversely, devices associated with low-power lamps, in particular compact fluorescent lamps, draw a very distorted current (see **fig. 12**). The total harmonic distortion can be as high as 150%. In these conditions, the rms current drawn from the line

supply equals 1.8 times the current corresponding to the lamp active power, which corresponds to a power factor of 0.55.

In order to balance the load between the different phases, lighting circuits are usually connected between phases and neutral in a balanced way. In these conditions, the high level of third harmonic and harmonics that are multiples of 3 can cause an overload of the neutral conductor. The least favorable situation leads to a neutral current which may reach $\sqrt{3}$ times the current in each phase. For more information, read Cahier Technique no. 202 "The singularities of the third harmonic".

Harmonic emission limits for lighting systems are set by standard IEC 61000-3-2. For example, for power devices above 25 W, the percentage of third harmonic should be less than 30% of the fundamental current.

Leakage currents

Electronic ballasts usually have capacitors placed between the power supply conductors and the earth. These interference-suppressing capacitors are responsible for the circulation of a permanent leakage current in the order of 0.5 to 1 mA per ballast. This therefore results in a limit being placed on the number of ballasts that can be supplied by a Residual Current Differential Safety Device (RCD) (See Cahier Technique no. 114).

At switch-on, the initial load of these capacitors can also cause the circulation of a current peak whose magnitude can reach several amps for 10 μ s. This current peak may cause unwanted tripping of unsuitable devices.

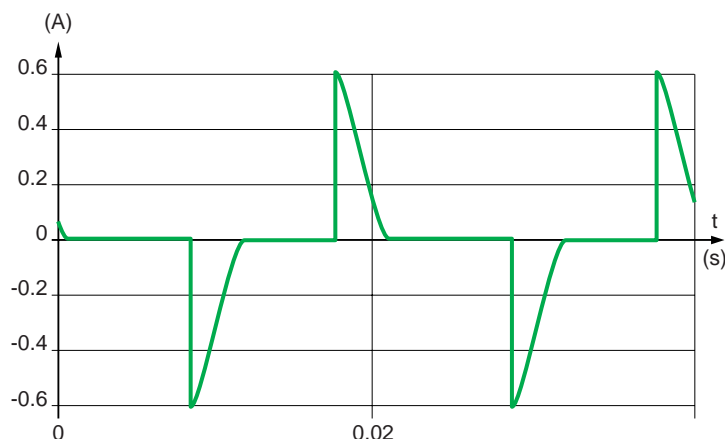

Fig. 12 : shape of the current drawn by a compact fluorescent lamp.

High-frequency emissions

Electronic ballasts are responsible for high-frequency conducted and radiated emissions.

The very steep rising edges applied to the ballast output conductors cause current pulses circulating in the stray capacities to earth (see **fig. 13**). As a result, stray currents circulate in the earth conductor and the power supply conductors. Due to the high frequency of these currents, there is also electromagnetic radiation. To limit these HF emissions, the lamp should be placed in the immediate proximity of the ballast, thus reducing the length of the most strongly radiating conductors.

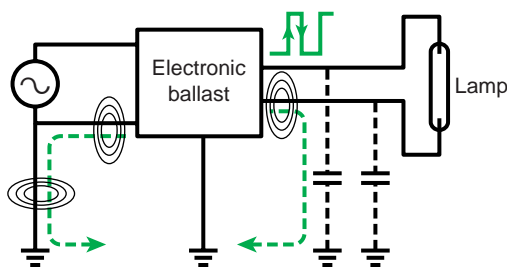

Fig. 13 : high-frequency emission loops linked to an electronic ballast.

To avoid these conducted and radiated emissions disturbing certain sensitive systems (power line or radio wave communication devices), interference-suppressing filters are incorporated in the ballasts.

Conformity with standard EN55015 requires emission limits in the 9 kHz - 30 MHz band.

Light dimmers for electronic ballasts

The use of electronic ballasts makes it possible to vary the brightness of fluorescent tubes. There are a number of possibilities, depending on the ballast technology:

- Ballast powered by a dimmer switch that varies the voltage by phase angle. The current supplied to the tube is a function of the voltage applied to the ballast entry point.

- Ballast controlled by a 0 to 10 V external signal. The ballast then supplies the tube with a variable-frequency voltage which can vary the current and hence the level of brightness produced. This is the most commonly used solution (see **fig. 14**).

- Ballast controlled by a digital control signal.

The use of dimmers can also save energy by reducing the amount of light at certain times, depending on occupation of the premises. Electronic ballasts are incompatible with timers with a switch-off warning.

Comment: If the electronic ballast is powered by an electronic switch, there is a risk of intermittent ignition of the fluorescent tubes. In fact, a capacitor (0.1 to 0.2 μF) is usually placed in parallel on the switch to protect it from transient overvoltages. As a result, a leakage current occurs which can trigger ignition unintentionally. The use of a pre-charging circuit, which can shift the leakage current, is compulsory.



Fig. 14 : remote dimmer for electronic ballast (Merlin Gerin brand).

5 Technical characteristics and usage of lighting devices

5.1 Main technical characteristics

Technology	Power (watt)	Efficiency (lumen/watt)	Service life (hours)
Standard incandescent	3 – 1,000	10 – 15	1,000 – 2,000
Halogen incandescent	5 – 500	15 – 25	2,000 – 4,000
Fluorescent tube	4 – 56	50 – 100	7,500 – 24,000
Compact fluorescent lamp	5 – 40	50 – 80	10,000 – 20,000
HP mercury vapor	40 – 1,000	25 – 55	16,000 – 24,000
High-pressure sodium	35 – 1,000	40 – 140	16,000 – 24,000
Low-pressure sodium	35 – 180	100 – 185	14,000 – 18,000
Metal halide	30 – 2,000	50 – 115	6,000 – 20,000
LED	0.05 – 0.1	10 – 30	40,000 – 100,000

In all cases, the service life of lamps is reduced by frequent ignition, except for induction compact fluorescent lamps and LEDs.

5.2 Fields of application, advantages and disadvantages

Technology	Application	Advantages	Disadvantages
Standard incandescent	- Domestic use - Localized decorative lighting	- Direct connection without intermediate switchgear - Reasonable purchase price - Compact size - Instantaneous lighting - Good color rendering	- Low luminous efficiency and high electricity consumption - Significant heat dissipation - Short service life
Halogen incandescent	- Spot lighting - Intense lighting	- Direct connection - Instantaneous efficiency - Excellent color rendering	- Average luminous efficiency
Fluorescent tube	- Shops, offices, workshops - Outdoors	- High luminous efficiency - Average color rendering	- Low light intensity of single unit - Sensitive to extreme temperatures
Compact fluorescent lamp	- Domestic use - Offices - Replacement of incandescent lamps	- Good luminous efficiency - Good color rendering	- High initial investment compared to incandescent lamps
HP mercury vapor	- Workshops, halls, hangars - Factory floors	- Good luminous efficiency - Acceptable color rendering - Compact size - Long service life	- Lighting and relighting time of a few minutes
High-pressure sodium	- Outdoors - Large halls	- Very good luminous efficiency	- Lighting and relighting time of a few minutes
Low-pressure sodium	- Outdoors - Emergency lighting	- Good visibility in foggy weather - Economical to use	- Long lighting time (5 min.) - Mediocre color rendering
Metal halide	- Large areas - Halls with high ceilings	- Good luminous efficiency - Good color rendering - Long service life	- Lighting and relighting time of a few minutes
LED	- Signaling (3-color traffic lights, "exit" signs and emergency lighting)	- Insensitive to the number of switching operations - Low energy consumption - Low temperature	- Limited number of colors - Low brightness of single unit

5.3 The different power supply modes

Technology	Power supply mode	Other device
Standard incandescent	Direct power supply	Dimmer switch
Halogen incandescent		
ELV halogen incandescent	Transformer	Electronic converter
Fluorescent tube	Magnetic ballast and starter	Electronic ballast Electronic dimmer + ballast
Compact fluorescent lamp	Built-in electronic ballast	
Mercury vapor	Magnetic ballast	Electronic ballast
High-pressure sodium		
Low-pressure sodium		
Metal halide		

6 Difficulties and recommendations

6.1 Constraints related to lighting devices and recommendations

The current actually drawn by luminaires

■ The risk

This characteristic is the first one that should be defined when creating an installation, otherwise it is highly probable that overload protection devices will trip and users will often find themselves in the dark.

It is evident that their determination should take into account the consumption of all components, especially for fluorescent lighting installations, since the power consumed by the ballasts has to be added to that of the tubes and bulbs.

■ The solution

For fluorescent lighting, remember that unless otherwise specified, the power of the magnetic ballasts can be assessed at 25% of that of the bulbs. For electronic ballasts, this power is lower, in the order of 5 to 10%.

For incandescent lighting, it should be remembered that the line voltage can be more than 10% of its nominal value, which would then cause an increase in the current drawn.

The thresholds for the overcurrent protection devices should therefore be calculated as a function of the total power and the power factor, calculated for each circuit.

Overcurrents at switch-on

■ The risk

The devices used for control and protection of lighting circuits are those such as relays, triac, remote-control switches, contactors or circuit-breakers.

The main constraint applied to these devices is the current peak on energization, described in sections 3 and 4.

This current peak depends on the technology of the lamps used, but also on the installation characteristics (supply transformer power, length of cables, number of lamps) and the moment of energization in the line voltage period. A high current peak, however fleeting, can cause the contacts on an electromechanical control device to weld together or the destruction of a solid state device with semi-conductors.

■ Two solutions

Because of the inrush current, the majority of ordinary relays are incompatible with lighting device power supply. The following recommendations are therefore usually made:

□ Limit the number of lamps to be connected to a single device so that their total power is less than the maximum permissible power for the device.

□ Check with the manufacturers what operating limits they suggest for the devices. This precaution is particularly important when replacing incandescent lamps with compact fluorescent lamps.

By way of example, the table in **figure 15** indicates the maximum number of compensated fluorescent tubes that can be controlled by different devices with 16 A rating. Note that the number of controlled tubes is well below the number corresponding to the maximum power for the devices.

Tube unit power requirement (W)	Number of tubes corresponding to the power 16 A x 230 V	Maximum number of tubes that can be controlled by		
		Contactors GC16 A CT16 A	Remote control switches TL16 A	Circuit-breakers C60-16 A
18	204	15	50	112
36	102	15	25	56
58	63	10	16	34

Fig. 15 : the number of controlled tubes is well below the number corresponding to the maximum power for the devices.

These operating limits must be adhered to when an existing installation is being worked on. But a technique exists to limit the current peak on energization of circuits with capacitive behavior (magnetic ballasts with parallel compensation and electronic ballasts). It consists of ensuring that activation occurs at the moment when the line voltage passes through zero. Only solid state devices with semi-conductors offer this possibility. This technique has proved to be particularly useful when designing new lighting circuits.

More recently, hybrid technology devices have been developed that combine a solid state switch (activation on voltage passage through zero) and an electromechanical contactor short-circuiting the solid state switch (reduction of losses in the semi-conductors) (see **fig. 16**).

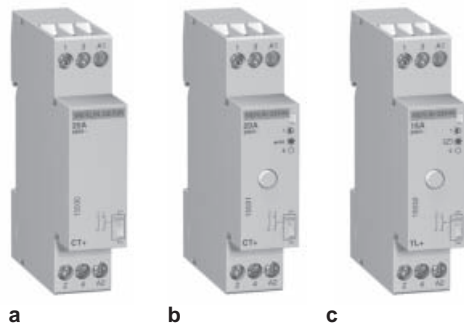

Fig. 16 : “standard” CT+ contactor [a], CT+ contactor with manual override, pushbutton for selection of operating mode and indicator lamp showing the active operating mode [b], and TL+ remote-control switch [c] (Merlin Gerin brand).

Overload of the neutral conductor

■ The risk

In an installation including, for example, numerous fluorescent tubes with electronic ballasts supplied between phases and neutral, the number of third order harmonic and harmonics that are multiples of 3 can cause an overload of the neutral conductor.

■ The solution

Firstly, the use of a neutral conductor with a small cross-section (half) should be prohibited. Installation standards IEC 60364, section 523-5-3, is clear on this point:

“If the neutral conductor carries current without a reduction factor corresponding to the load of the phase conductors, the neutral conductor should be taken into account for the rated circuit current. Such currents may be due to significant harmonic currents in the 3-phase circuits. If the value of the harmonics exceeds 10%, the neutral conductor should not have a cross-section less than that of the phase conductors.”

As far as overcurrent protection devices are concerned, it is necessary to provide 4-pole circuit-breakers with protected neutral (except with the TN-C system for which the PEN, a combined neutral and protection conductor, should not be cut).

This type of device can also be used for the breaking of all poles necessary to supply luminaires at the phase-to-phase voltage in the event of a fault. Indeed, as shown in the example in **figure 17**, this cut-off could cause certain single-phase loads to be supplied at a voltage distinctly higher than their nominal voltage and cause their destruction due to thermal stress or breakdown relating to the overvoltage.

A breaking device should therefore interrupt the phase and Neutral circuit **simultaneously**.

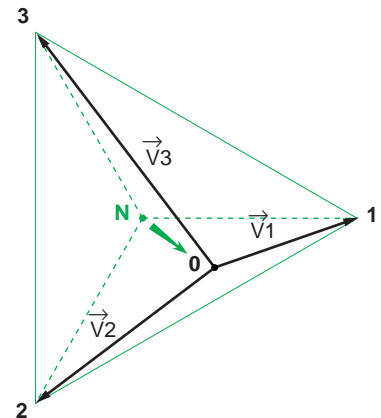
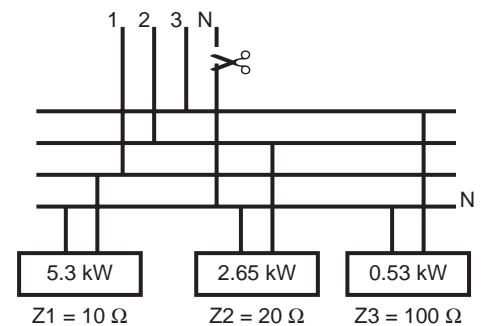

	Voltages (V) between phases and Neutral:	
	in normal use	after disconnecting the Neutral
V1	230	150
V2	230	275
V3	230	375

Fig. 17 : consequences of disconnecting the Neutral conductor only in an installation when the single-phase loads are unevenly balanced.

Leakage currents to earth

■ The risk

At switch-on, the earth capacitances of the electronic ballasts are responsible for residual current peaks that are likely to cause unintentional tripping of protection devices.

■ Two solutions

The use of Residual Current Devices immune against this type of impulse current is recommended, even essential, when equipping an existing installation (see **fig. 18**).

For a new installation, it is sensible to provide solid state or hybrid control devices (contactors and remote-control switches) that reduce these

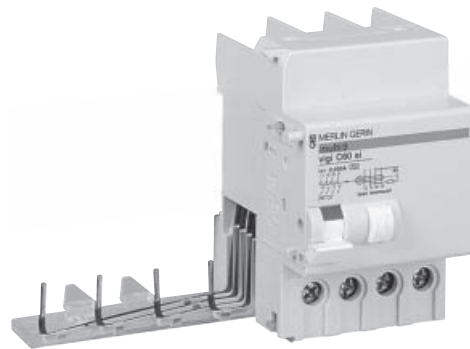

Fig. 18 : s.i. residual current devices with immunity against impulse currents (Merlin Gerin brand).

impulse currents (activation on voltage passage through zero).

HF disturbances

■ The risk

HF emissions, conducted and radiated, can disturb certain sensitive systems (power line or radio wave communication devices).

■ The solution

It is also possible to reduce HF emissions at the time of installation: this requires the lamp to be placed in the immediate proximity of the ballast, so as to limit the length of the conductors subject to voltage gradients.

Overvoltages

■ The risk

As we illustrated in earlier sections, switching on a lighting circuit causes a transient state which is manifested by a significant overcurrent. This overcurrent is accompanied by a strong voltage fluctuation applied to the load terminals connected to the same circuit.

These voltage fluctuations can be detrimental to correct operation of sensitive loads (micro-computers, temperature controllers, etc).

■ The solution

It is advisable to separate the power supply for these sensitive loads from the lighting circuit power supply.

6.2 Sensitivity of lighting devices to line voltage disturbances

Short interruptions

■ The risk

Discharge lamps require a relighting time of a few minutes after their power supply has been switched off.

■ The solution

Partial lighting with instantaneous relighting (incandescent lamps or fluorescent tubes) should be provided if safety requirements so dictate. Its power supply circuit is, depending on current regulations, usually distinct from the main lighting circuit.

Voltage fluctuations

■ The risk

The majority of lighting devices (with the exception of lamps supplied by electronic ballasts) are sensitive to rapid fluctuations in the supply voltage. These fluctuations cause a flicker phenomenon which is unpleasant for users and may even cause significant problems.

These problems depend on both the frequency of variations and their magnitude.

Standard IEC 61000-2-2 ("compatibility levels for low-frequency conducted disturbances") specifies the maximum permissible magnitude of voltage variations as a function of the number of variations per second or per minute.

These voltage fluctuations can be caused by high-power fluctuating loads (arc furnaces, welding machines, starting motors) or remote control signals (ie: Pulsadis, at 175 or 188 Hz used by EDF -Electricité de France-).

■ The solution

Special methods can be used to reduce voltage fluctuations. Nonetheless, it is advisable, wherever possible, to supply lighting circuits via a separate line supply.

The use of electronic ballasts that can be controlled at 1-10 V is recommended for demanding applications (hospitals, clean rooms, inspection rooms, computer rooms, etc).

High line voltage

■ The risk

A high line voltage is responsible for reducing the service life of incandescent lamps. This difficulty is encountered in areas where the voltage regulation provided by the energy distributor is inadequate.

■ The solution

Dimmers can be used, but are not a common solution. The use of compact fluorescent lamps is recommended if the installation allows.

6.3 Choice of light dimmers

Light dimmer technology should be adapted to the lamp and luminaire technology:

- incandescent lamps: dimmer switches with triac, voltage variation by varying the firing angle,
- electronic ballasts with variable voltage: dimmer switches with triac, voltage variation by varying the firing angle (this technology is on the way out),
- electronic ballasts that can be controlled by a 1-10 V signal,
- dimmer switches with automatic matching to ELV transformers or electronic converters.

Light dimmers supply the lamps gradually at switch-on, and thus reduce high inrush currents. Their use therefore avoids any derating of control and protection devices and oversizing of conductors.

Precautions should still be taken to ensure the reliability of installations and it is especially necessary to check that no overload is imposed on electronic devices, for example by using the information provided by switchgear manufacturers (see [fig. 19](#)).

Type of lamp	Auxiliary switchgear required	Remote dimmer or dimmer -Merlin Gerin-	Variation range	Maximum unit power (W)	Pre-charging device
LV incandescent or halogen 230 V		TV700 TVe700 TVo1000 Vo1000	5 to 95%	700 500 1000 1000	
ELV halogen 12/24 V	Ferromagnetic transformer	TVe700 TVo1000 Vo1000		550 800 800	PTV1
	"Universal" electronic transformer	TVe700 TVo1000 Vo1000		650 800 800	PTV1
	"Standard" electronic transformer	TVe700		650	PTV1
Standard fluorescent tube (18, 36 or 58 W)	Ferromagnetic ballast and starter	Dimming not possible			
	Standard electronic ballast				
	Remote control electronic ballast 1-10 V	TVBo	Depend on ballast specifications	1500	
Compact fluorescent	Electronic ballast integrated in the lamp	Dimming not possible			

Note:

In addition to the limits indicated in this table, a 30% reduction in the permissible power must be allowed for in the following cases:

- switchgear placed in small non-ventilated cabinets or enclosures with a high density of power switchgear (circuit-breakers, contactors, solid state contactors, remote control dimmers, etc)
- ambient temperature of the premises likely to exceed 30° C.

To reduce the thermal stress on modular electronic devices, we recommend that neighboring equipment with significant dissipation kept separate by ventilation modules.

Fig. 19 : manufacturer data for the selection of light dimmers (Merlin Gerin brand).

7 Conclusions: technological developments and professional requirements

7.1 Developments in luminaires

The main technological developments envisaged are related to energy saving, encouraged by statutory regulations (European Directive and Energy Policy Act in the USA). For this reason, new installations are equipped with lamps with a strong light output, whereas old installations are often subjected to retrofit work.

In these conditions, the use of electronic ballasts is likely to increase, to the detriment of magnetic

ballasts. The major preoccupation of manufacturers of luminaires is now to reduce constraints on energization such as harmonic currents, especially for compact fluorescent lamps.

A trend towards reduction or even total elimination of mercury in lamps can also be observed.

7.2 Developments in control and protection equipment

The use of light dimmers is more and more common. The constraints on ignition are therefore reduced and derating of control and protection equipment is less important.

New protection devices adapted to the constraints on lighting circuits are being introduced, for example Merlin Gerin brand circuit-breakers and

modular residual current circuit-breakers with special immunity, such as ID switches and s.i. type Vigi circuit-breakers. As control and protection equipment evolves, some now offer remote control, 24-hour management, lighting control, reduced consumption, etc.

7.3 The necessity for suitable equipment

Manufacturers are subjected to ongoing developments in equipment standards which are necessary to satisfy all users of electrical lighting. But the quality and continuity of service of a lighting installation depends to a large extent on whether the right lamp is used with the right switchgear.

This is why certain manufacturers, aware of the difficulties that all electrical contractors

encounter in choosing luminaires and control and protection equipment, offer a variety of purpose-designed tools, for example Schneider Electric publishes selection guides in association with their catalogues and this Cahier Technique.

Designers and installers are thus provided with the means to create lighting circuits which are both safe during operation and pleasant to use.

Bibliography

“Product” standards with particular relevance to lighting equipment

The extensive list of standards below, although not exhaustive, demonstrates the importance of this field for the standards authorities.

■ IEC 60570: Electrical supply track systems for luminaires.

■ IEC 60598: Luminaires.

Part 1: General requirements and tests.

Part 2: Particular requirements including, for example, among the 25 sections published or in progress:

Section 1: Fixed general purpose luminaires,

Section 2: Recessed luminaires,

Section 10: Portable child-appealing luminaires.

■ IEC 60669: Switches for household and similar fixed-electrical installations.

Part 1: General requirements.

Part 2: Particular requirements including:

Section 1: Electronic switches,

Section 2: Electromagnetic remote-control switches (R.C.S.),

Section 3: Particular requirements - Time-delay switches (TDS).

■ IEC 60730: Automatic electrical controls for household and similar use.

Part 2-3: Particular requirements for thermal protectors for ballasts for tubular fluorescent lamps.

Part 2-7: Particular requirements for timers and time switches.

Part 2-11: Particular requirements for energy regulators.

■ IEC 60742: Isolating transformers and safety isolating transformers. Requirements.

■ IEC 60921: Ballasts for tubular fluorescent lamps. Performance requirements.

■ IEC 60927: Auxiliaries for lamps - Starting devices (other than glow starters) - Performance requirements.

■ IEC 60929: A.C. supplied electronic ballasts for tubular fluorescent lamps - Performance requirements.

■ IEC 60968: Self-ballasted lamps for general lighting services - Safety requirements.

■ IEC 60969: Self-ballasted lamps for general lighting services - Performance requirements.

■ IEC 61000: Electromagnetic compatibility (EMC).

Part 2-2: Environment - Compatibility levels for low-frequency conducted disturbances and signaling in public low-voltage power supply systems.

Part 3-2: Limits - Limits for harmonic current emissions (equipment input current ≤ 16 A per phase).

■ IEC 61347: Lamp controlgear

Part 1: General and safety requirements.

Part 2: sections 1 to 11: Particular requirements for starting devices and the various types of ballast.

“Product” standards applicable to the most commonly used protection devices for lighting circuits

■ IEC 61009: Residual current operated circuit-breakers with integral overcurrent protection for household and similar uses (RCBOs).

“Installation” standards

■ IEC 60364: Electrical installations of buildings.

Schneider Electric Cahiers Techniques

■ Residual current devices in LV.

R. CALVAS, Cahier Technique no. 114.

■ Earthing systems in LV.

B. LACROIX et R. CALVAS, Cahier Technique no. 172.

■ The singularities of the third harmonic.

J. SCHONEK, Cahier Technique no. 202.

Internet (<http://www.>)

■ sdv.fr/aimt67/dossier/eclairage.html

Workplace lighting: basic concepts. Site for the Intercompany Association of Workplace Medicine in the Lower Rhine –AIMT 67-.

■ feder-eclairage.fr

Lighting Syndicate site.

■ inrs.fr/indexnosdoss.html

Documents for designing workplaces.

Site for the National Research and Safety Institute (INRS).

■ For standards:

AFNOR <http://www.afnor.fr/>

IEC <http://www.iec.ch/home-f.htm>

CENELEC <http://www.cenelec.org/>

ISO <http://www.iso.ch/indexf.html>

UTE <http://www.ute-fr.com/>

Schneider Electric

Direction Scientifique et Technique,
Service Communication Technique
F-38050 Grenoble cedex 9
Télécopie : 33 (0)4 76 57 98 60
E-mail : fr-tech-com@mail.schneider.fr

DTP: AXESS - Valence (26).
Edition : Schneider Electric
.
- 20 € -