

PacT Series

ComPacT NSX DC Circuit Breakers 100-1200 A and Switch-Disconnectors 100-630 A

User Guide

PacT Series offers world-class breakers and switches

DOCA0186EN-02
06/2024



Legal Information

The information provided in this document contains general descriptions, technical characteristics and/or recommendations related to products/solutions.

This document is not intended as a substitute for a detailed study or operational and site-specific development or schematic plan. It is not to be used for determining suitability or reliability of the products/solutions for specific user applications. It is the duty of any such user to perform or have any professional expert of its choice (integrator, specifier or the like) perform the appropriate and comprehensive risk analysis, evaluation and testing of the products/solutions with respect to the relevant specific application or use thereof.

The Schneider Electric brand and any trademarks of Schneider Electric SE and its subsidiaries referred to in this document are the property of Schneider Electric SE or its subsidiaries. All other brands may be trademarks of their respective owner.

This document and its content are protected under applicable copyright laws and provided for informative use only. No part of this document may be reproduced or transmitted in any form or by any means (electronic, mechanical, photocopying, recording, or otherwise), for any purpose, without the prior written permission of Schneider Electric.

Schneider Electric does not grant any right or license for commercial use of the document or its content, except for a non-exclusive and personal license to consult it on an "as is" basis.

Schneider Electric reserves the right to make changes or updates with respect to or in the content of this document or the format thereof, at any time without notice.

To the extent permitted by applicable law, no responsibility or liability is assumed by Schneider Electric and its subsidiaries for any errors or omissions in the informational content of this document, as well as any non-intended use or misuse of the content thereof.

Table of Contents

Safety Information.....	5
About the Book.....	7
ComPacT NSX DC Circuit Breakers	9
ComPacT NSX DC Circuit Breakers Presentation	10
PacT Series Master Range.....	11
ComPacT NSX DC Range.....	12
Operating the Circuit Breakers	17
EcoStruxure Power Commission Software	19
De-Energizing the Circuit Breaker	21
Environmental Conditions.....	24
Circuit Breaker With Toggle Handle.....	27
Front Face Description	28
Opening, Closing, and Resetting the Circuit Breaker.....	29
Testing the Circuit Breaker.....	31
Locking the Circuit Breaker.....	33
Circuit Breaker With Rotary Handle.....	35
Front Face Description	36
Opening, Closing, and Resetting the Circuit Breaker.....	38
Testing a Circuit Breaker With Direct Rotary Handle	40
Locking a Circuit Breaker With Direct Rotary Handle.....	42
Testing a Circuit Breaker With Extended Rotary Handle	45
Locking a Circuit Breaker With Extended Rotary Handle	47
Motor-Operated Circuit Breakers	50
Front Face Description	51
Opening, Closing, and Resetting a Circuit Breaker With Motor Mechanism.....	53
Opening, Closing, and Resetting Circuit Breakers With Communicating Motor Mechanism	57
Locking the Circuit Breaker.....	58
ComPacT NSX DC Installation Accessories	60
Installation Accessories Summary	61
Plug-in Circuit Breaker	62
Withdrawable Circuit Breaker	66
Accessories	74
ComPacT NSX DC Electric Auxiliary Devices	76
Electric Auxiliary Devices Summary	77
Standard Indication and Control Auxiliaries.....	82
Indication Contacts	83
Wireless Indication Auxiliary	85
Control Auxiliaries.....	90
Remote Indication and Communication Auxiliaries	92
BSCM Modbus SL/ULP Module Presentation.....	93
BSCM Modbus SL/ULP Module Modes	97
BSCM Modbus SL/ULP Module Configuration.....	102
Communication Test	106
BSCM Modbus SL/ULP Module Firmware Update	107
NSX Cord.....	108

Insulated NSX Cord	110
SD Auxiliary Contact for BSCM Modbus SL/ULP Module	112
Modbus SL Hub	114
ComPacT NSX DC Trip Units	116
Trip Unit Summary	117
TM-D Thermal-Magnetic Trip Unit for 1P and 2P Circuit Breakers.....	120
TM-D Thermal-Magnetic Trip Unit for 3P and 4P Circuit Breakers up to 63 A.....	121
TM-DC Thermal-Magnetic Trip Unit for 3P and 4P Circuit Breakers from 80 A to 250 A	123
TM-DC Thermal-Magnetic Trip Unit for 3P and 4P Circuit Breakers from 250 A to 600 A.....	125
TM-DC Thermal-Magnetic Trip Unit for 2P Circuit Breakers from 630 A to 1200 A.....	127
TM-G Thermal-Magnetic Trip Unit for 3P and 4P Circuit Breakers up to 250 A.....	129
TM-DC PV Thermal-Magnetic Trip Unit for 4P Circuit Breakers	131
TM-DC EP Thermal-Magnetic Trip Unit for 4P Circuit Breakers for 1500 Vdc Applications.....	134
Protection Against Ground Faults for Photovoltaic Applications	137
ComPacT NSX DC Circuit Breakers Operation	138
Commissioning	139
Maintaining the Circuit Breaker During Operation	143
Responding to a Trip.....	146
Troubleshooting	148
Appendix	150
BSCM Module With Commercial Reference LV434205.....	151
Index	155

Safety Information

Important Information

Read these instructions carefully, and look at the equipment to become familiar with the device before trying to install, operate, service, or maintain it. The following special messages may appear throughout this documentation or on the equipment to warn of potential hazards or to call attention to information that clarifies or simplifies a procedure.



The addition of this symbol to a “Danger” or “Warning” safety label indicates that an electrical hazard exists which will result in personal injury if the instructions are not followed.



This is the safety alert symbol. It is used to alert you to potential personal injury hazards. Obey all safety messages that follow this symbol to avoid possible injury or death.

DANGER

DANGER indicates a hazardous situation which, if not avoided, **will result in death or serious injury**.

WARNING

WARNING indicates a hazardous situation which, if not avoided, **could result in death or serious injury**.

CAUTION

CAUTION indicates a hazardous situation which, if not avoided, **could result in minor or moderate injury**.

NOTICE

NOTICE is used to address practices not related to physical injury.

Please Note

Electrical equipment should be installed, operated, serviced, and maintained only by qualified personnel. No responsibility is assumed by Schneider Electric for any consequences arising out of the use of this material.

A qualified person is one who has skills and knowledge related to the construction and operation of electrical equipment and its installation, and has received safety training to recognize and avoid the hazards involved.

Cybersecurity Safety Notice

⚠ WARNING

POTENTIAL COMPROMISE OF SYSTEM AVAILABILITY, INTEGRITY, AND CONFIDENTIALITY

- Change default passwords at first use to help prevent unauthorized access to device settings, controls, and information.
- Disable unused ports/services and default accounts to help minimize pathways for malicious attackers.
- Place networked devices behind multiple layers of cyber defenses (such as firewalls, network segmentation, and network intrusion detection and protection).
- Use cybersecurity best practices (for example, least privilege, separation of duties) to help prevent unauthorized exposure, loss, modification of data and logs, or interruption of services.

Failure to follow these instructions can result in death, serious injury, or equipment damage.

About the Book

Document Scope

The aim of this guide is to provide users, installers, and maintenance personnel with the technical information needed to operate ComPacT NSX direct current (DC) circuit breakers and switch-disconnectors in compliance with the IEC/EN standards.

Validity Note

This document applies to the range of ComPacT NSX DC circuit breakers and switch-disconnectors.

The characteristics of the products described in this document are intended to match the characteristics that are available on www.se.com. As part of our corporate strategy for constant improvement, we may revise the content over time to enhance clarity and accuracy. If you see a difference between the characteristics in this document and the characteristics on www.se.com, consider www.se.com to contain the latest information.

Online Information

The information contained in this guide is likely to be updated at any time. Schneider Electric strongly recommends that you have the most recent and up-to-date version available on www.se.com/ww/en/download.

Related Documents

Title of Documentation	Reference Number
<i>ComPacT NSX, ComPacT INS/INV, MasterPacT NW DC - DC PV Catalog</i>	LVPED221002EN
<i>ComPacT NSX - Modbus Communication Guide</i>	DOCA0213EN DOCA0213ES DOCA0213FR DOCA0213ZH
<i>Enerlin'X IO - Input/Output Application Module for One IEC Circuit Breaker - User Guide</i>	DOCA0055EN DOCA0055ES DOCA0055FR DOCA0055ZH
<i>ULP System (IEC Standard) - User Guide</i>	DOCA0093EN DOCA0093ES DOCA0093FR DOCA0093ZH
<i>MasterPacT, ComPacT, PowerPacT - Cybersecurity Guide</i>	DOCA0122EN DOCA0122ES DOCA0122FR DOCA0122ZH
ComPacT NSX100-160 AC/DC 1P Circuit Breaker - Instruction Sheet	NNZ4767307
ComPacT NSX100-160 AC/DC 2P Circuit Breaker - Instruction Sheet	NNZ4767407

Title of Documentation	Reference Number
ComPacT NSX100-250 DC 3P/4P Circuit Breakers and Switch-Disconnectors - Instruction Sheet	NNZ4767107
ComPacT NSX80-200 DC PV 4P Circuit Breaker - Instruction Sheet	NNZ4767507
ComPacT NSX100-200 NA DC PV 4P Switch-Disconnectors - Instruction Sheet	NNZ4767707
ComPacT NSX100-250 DC EP 4P Circuit Breaker and Switch-Disconnectors - Instruction Sheet	NNZ3566107
ComPacT NSX400-630 DC 3P/4P Circuit Breaker and Switch-Disconnectors - Instruction Sheet	NNZ4767207
ComPacT NSX250-500 DC PV 4P Circuit Breaker - Instruction Sheet	NNZ4766607
ComPacT NSX400-500 NA DC PV 4P Switch-Disconnectors - Instruction Sheet	NNZ4767607
ComPacT NSX250-500 DC EP 4P Circuit Breaker and Switch-Disconnectors - Instruction Sheet	NNZ3566207
ComPacT NSX630-1200 DC 2P Circuit Breaker - Instruction Sheet	NNZ4764607

You can download these technical publications and other technical information from our website at www.se.com/ww/en/download/.

Information on Non-Inclusive or Insensitive Terminology

As a responsible, inclusive company, Schneider Electric is constantly updating its communications and products that contain non-inclusive or insensitive terminology. However, despite these efforts, our content may still contain terms that are deemed inappropriate by some customers.

Trademarks

QR Code is a registered trademark of DENSO WAVE INCORPORATED in Japan and other countries.

ComPacT NSX DC Circuit Breakers

What's in This Part

ComPacT NSX DC Circuit Breakers Presentation	10
Circuit Breaker With Toggle Handle	27
Circuit Breaker With Rotary Handle	35
Motor-Operated Circuit Breakers	50

ComPacT NSX DC Circuit Breakers Presentation

What's in This Chapter

PacT Series Master Range	11
ComPacT NSX DC Range	12
Operating the Circuit Breakers	17
EcoStruxure Power Commission Software	19
De-Energizing the Circuit Breaker.....	21
Environmental Conditions	24

PacT Series Master Range

Future-proof your installation with Schneider Electric's low-voltage and medium-voltage PacT Series. Built on legendary Schneider Electric innovation, the PacT Series comprises world-class circuit breakers, switches, residual current devices and fuses, for all standard and specific applications. Experience robust performance with PacT Series within the EcoStruxure-ready switchgear, from 16 to 6300 A in low-voltage and up to 40.5 kV in medium-voltage.

ComPacT NSX DC Range

Description

The ComPacT NSX DC range covers the following applications:

- Electrical distribution protection
- Photovoltaic (PV) applications
- Marine applications

The ComPacT NSX DC range is compliant with the following standards:

- IEC 60947-2 for circuit breakers
- IEC 60947-3 for switch-disconnectors

The ComPacT NSX direct current (DC) range consists of:

- Circuit breakers operating on direct current from 16 to 600 A up to 750 Vdc
- Circuit breakers operating on direct current from 630 to 1200 A up to 600 Vdc
- Switch-disconnectors operating on direct current from 16 to 630 A up to 750 Vdc
- Switch-disconnectors operating on direct current from 100 to 630 A up to 1500 Vdc
- A set of standard accessories and auxiliaries shared with the ComPacT NSX AC range
- A set of specific accessories to meet the needs of series or parallel connection of poles required in high-voltage DC systems
- Circuit breakers for general-purpose (GP) applications including DC distribution for critical services (for example: Telecom, auxiliaries, and safety services):
 - 1 and 2 poles from 16 to 160 A up to 750 Vdc
 - 3 and 4 poles from 16 to 600 A up to 750 Vdc
 - 2 poles from 630 to 1200 A, obtained from a ComPacT NSX 4P 630 A with 2 poles in parallel, up to 600 Vdc
- Circuit breakers for photovoltaic (PV) and marine applications:
 - 4 poles from 80 to 500 A up to 1000 Vdc
 - 4 poles from 100 to 500 A up to 1500 Vdc
- Switch-disconnectors for photovoltaic (PV) and marine applications:
 - 4 poles from 80 to 500 A up to 1000 Vdc
 - 4 poles from 100 to 500 A up to 1500 Vdc

Convention

In this guide, the term *circuit breaker* covers circuit breakers and switch-disconnectors.

Fixed Circuit Breaker

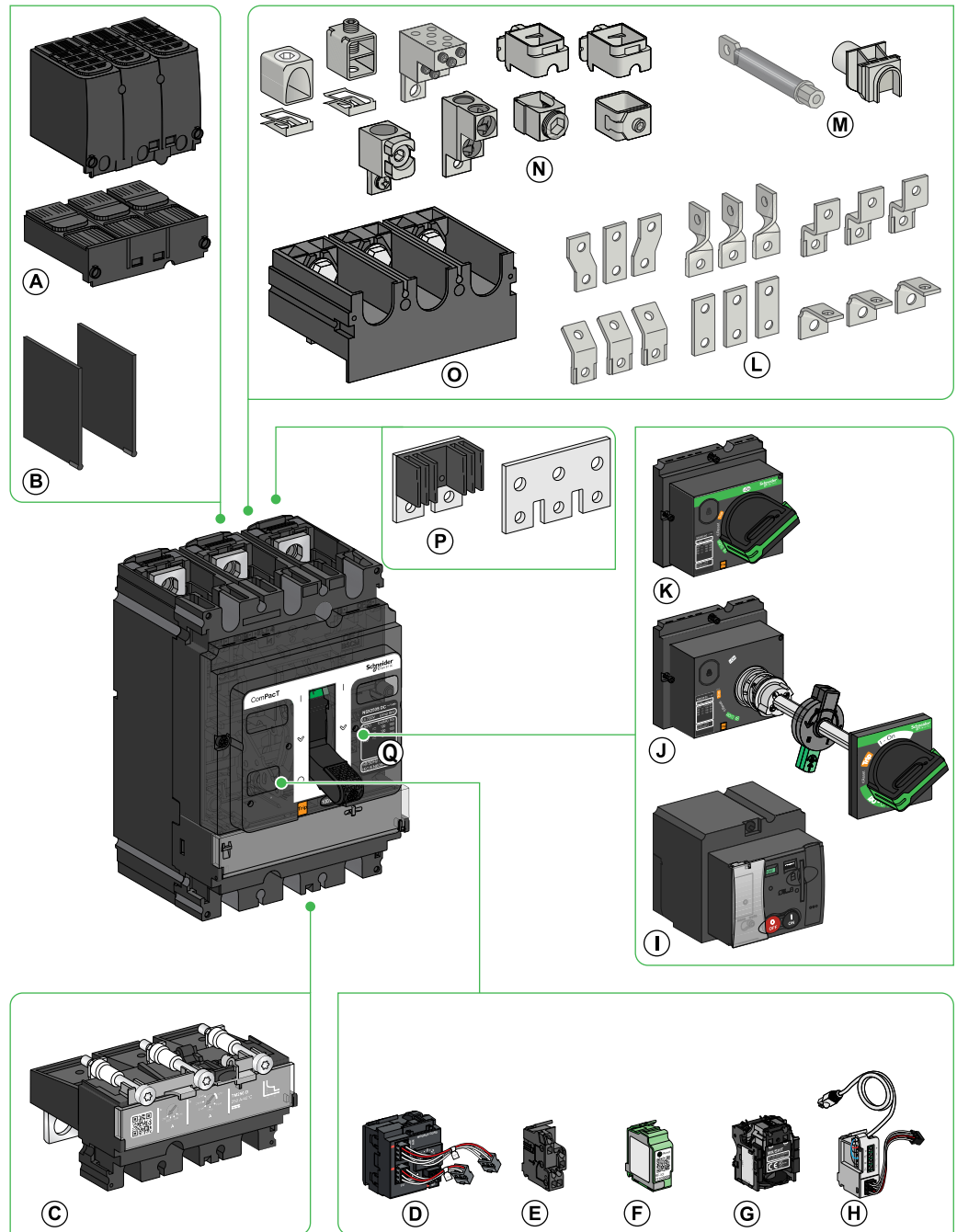

- A** Sealable terminal shields
- B** Interphase barriers
- C** TM-D, TM-G trip unit
- D** BSCM Modbus SL/ULP module
- E** Indication contact
- F** Wireless indication auxiliary
- G** Voltage release
- H** NSX cord
- I** Motor mechanism
- J** Extended rotary handle
- K** Direct rotary handle
- L** Terminal extensions
- M** Rear connectors
- N** Cable connectors
- O** One-piece spreader
- P** Parallel and series connectors
- Q** Toggle handle

Withdrawable or Plug-in Circuit Breaker

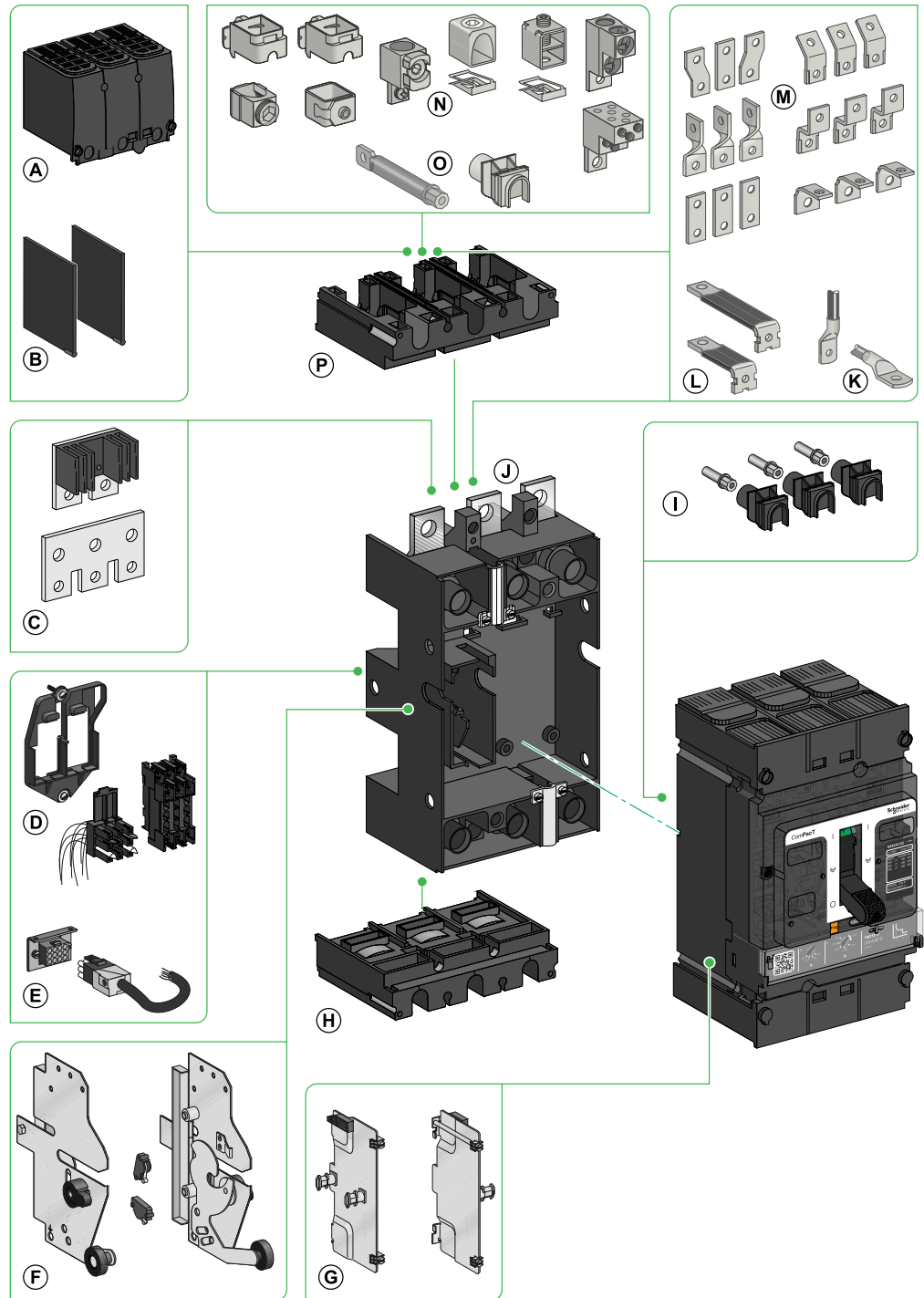

- A** Sealable long terminal shields for plug-in base
- B** Interphase barriers
- C** Parallel and series connectors
- D** Automatic withdrawable auxiliary connector
- E** Manual auxiliary connector

- F** Chassis side plate for withdrawable circuit breaker
- G** Circuit-breaker side plate
- H** Adapter
- I** Power connections
- J** Circuit-breaker plug-in base

- K** Lugs
- L** Rear connectors
- M** Terminal extensions
- N** Cable connectors
- O** Rear connectors
- P** Adapter

Identification

The faceplate on the front of the circuit breaker identifies the circuit breaker and its characteristics.

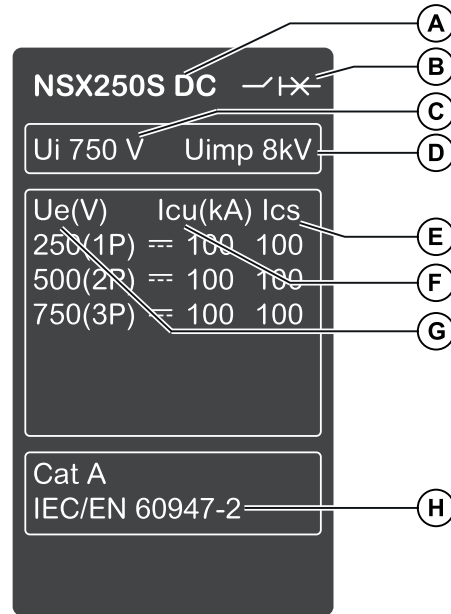

- A** Device size and rated current
- B** Circuit breaker disconnecter symbol
- C** U_i : rated insulation voltage
- D** U_{imp} : rated impulse withstand voltage
- E** I_{cs} : rated service short-circuit breaking capacity
- F** I_{cu} : rated ultimate short-circuit breaking capacity
- G** U_e : rated operational voltage
- H** Standards

ComPacT NSX DC EP 1500 Vdc Circuit Breaker

The ComPacT NSX DC EP circuit breaker is dedicated to applications up to 1500 Vdc and has the following characteristics:

- Ultimate breaking capacity I_{cu} = 50 kA at 1500 Vdc
- Service breaking capacity I_{cs} = 20 kA at 1500 Vdc
- Supplied with a non-interchangeable thermal-magnetic trip unit
- Adjustable ratings: 100 A to 500 A
- 4 poles from 16 to 500 A

The following restrictions apply to ComPacT NSX DC EP circuit breakers:

- Not compatible with plug-in base or chassis
- No communication available
- Rear connection available only for frame size 100 A to 250 A.

Trip Units

The ComPacT NSX DC circuit breakers use thermal-magnetic trip units.

For more information about trip units, see the related description, page 117.

Trip Unit Settings

The circuit breaker trip unit settings must satisfy the requirements of the performance and installation diagram.

The dial positions on the front of the thermal-magnetic trip unit set the circuit breaker pickup settings.

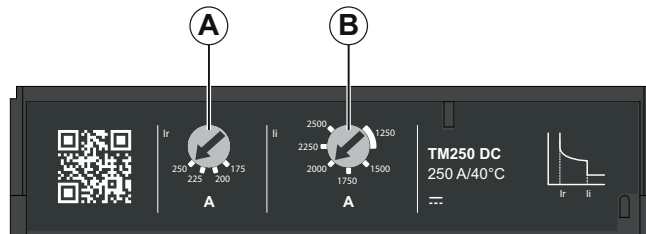

A Overload protection setting

B Short-circuit protection setting

Operating the Circuit Breakers

Circuit Breaker Operating Control Accessories for General-Purpose Applications

The following table shows the operating control accessories compatible with the ComPacT NSX DC circuit breakers for general-purpose applications. For more information, refer to [LVPED221002EN ComPacT NSX](#), [ComPacT INS/INV](#), [MasterPacT NW DC - DC PV Catalog](#).

Operating Control Accessory	NSX100 DC			NSX160 DC			NSX250 DC	NSX400 DC	NSX630 DC	NSX1200 DC
	1P	2P	3P/4P	1P	2P	3P/4P	3P/4P	3P/4P	3P/4P	2P
Toggle handle	✓	✓	✓	✓	✓	✓	✓	✓	✓	✓
Rotary handle	-	-	✓	-	-	✓	✓	✓	✓	✓
Motor mechanism	-	-	✓	-	-	✓	✓	✓	✓	✓
Communicating motor mechanism	-	-	✓	-	-	✓	✓	✓	✓	✓

Circuit Breaker Operating Control Accessories for Photovoltaic and Marine Applications

The following table shows the operating control accessories compatible with the ComPacT NSX DC PV and DC EP circuit breakers for photovoltaic and marine applications. For more information, refer to [LVPED221002EN ComPacT NSX](#), [ComPacT INS/INV](#), [MasterPacT NW DC - DC PV Catalog](#).

Operating Control Accessory	NSX80-200 DC PV	NSX400-500 DC PV	NSX100-250 DC EP	NSX250-500 DC EP
	4P	4P	4P	4P
Toggle handle	✓	✓	✓	✓
Rotary handle	✓	✓	✓	✓
Motor mechanism	✓	✓	-	-
Communicating motor mechanism	✓	✓	-	-

Handle Position

The handle position indicates the state of the circuit breaker:

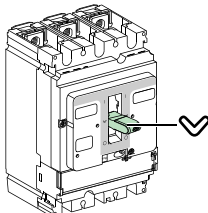
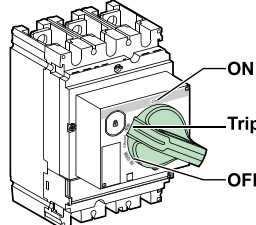
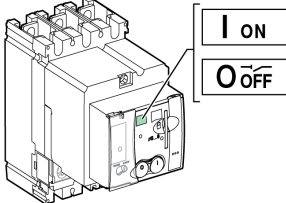
Toggle handle	Rotary handle	Motor mechanism
		
<ul style="list-style-type: none"> • I (ON): Circuit breaker closed. Closed manually. • O (OFF): Circuit breaker open. Opened manually. • Trip: Circuit breaker tripped. Tripped by the protection (trip unit or trip auxiliaries), the push-to-trip button, or the USB maintenance interface. 		<ul style="list-style-type: none"> • I (ON): Circuit breaker closed (in Auto or Manu mode). • O (OFF): Circuit breaker open or tripped (in Auto or Manu mode).

Remote Indication

Information is available remotely:

- From the indication contacts
- From the wireless indication auxiliaries
- By using a communication network

These indication auxiliaries can be installed on site.

For more information about the remote indication and communication options, refer to the summary tables of auxiliaries, page 77.

Remote Electrical Stop Command

The remote electrical stop command can be given by electrical control auxiliaries regardless of the control type in use.

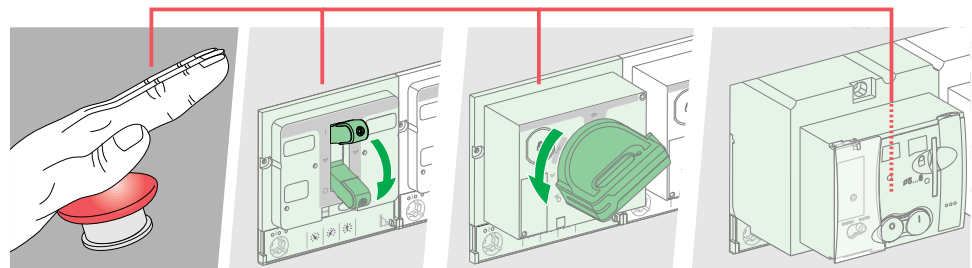

To obtain a remote electrical stop command, use:

- an MX shunt trip release, or
- an MN undervoltage trip release, or
- an MN undervoltage trip release with time-delay unit (the time-delay unit overcomes the problem of micro-cuts).

For more information about the electrical control auxiliaries, refer to the relevant topic, page 90.

NOTE: It is advisable to test operation of the remote electrical stop commands at regular intervals (every six months).

EcoStruxure Power Commission Software

Overview

EcoStruxure Power Commission software automatically discovers the smart devices and allows you to add the devices for an easy configuration. You can generate comprehensive reports as part of Factory Acceptance Test and Site Acceptance Test to replace your heavy manual work. Additionally, when the panels are under operation, any change of settings made can be easily identified by a yellow highlighter. This indicates the difference between the project and device values, and hence provides a system consistency during the operation and maintenance phase.

EcoStruxure Power Commission software enables the configuration of ComPacT NSX circuit breakers with the following modules, and accessories:

- MicroLogic trip units
- Communication interface modules:
 - BSCM Modbus SL/ULP module
 - IFM communication interface
 - IFE communication interface
- ULP modules:
 - IO module
 - FDM121 display

EcoStruxure Power Commission software enables the configuration of the following gateways and wireless devices:

- EcoStruxure Panel Server
- PowerTag Link gateway
- PowerTag Energy module
- Wireless indication auxiliary

Click [here](#) to download the latest version of EcoStruxure Power Commission software.

Key Features

EcoStruxure Power Commission software performs the following actions for the supported devices and modules:

- Create projects by device discovery
- Save the project in the EcoStruxure Power Commission cloud for reference
- Upload settings to the device and download settings from the device
- Compare the settings between the project and the device
- Perform control actions in a secured way
- Generate and print the device settings report
- Perform a communication wiring test on the entire project and generate and print test report
- View the communication architecture between the devices in a graphical representation
- View the measurements, logs, and maintenance information
- View the status of device and IO module
- View the alarm details
- Check the system firmware compatibility status
- Update to the latest device firmware

- Perform force trip and automatic trip curve test

De-Energizing the Circuit Breaker

Isolation Capacity

ComPacT NSX circuit breakers offer positive contact indication and are suitable for isolation in accordance with standards IEC/EN 60947-1 and 2. The **O (OFF)** position of the actuator is sufficient to isolate the circuit breaker concerned.

The following marking on the faceplate label indicates that the circuit breaker is capable of isolation:



To confirm this capability, standards IEC/EN 60947-1 and 2 require specific shock withstand tests.

ComPacT NSX circuit breakers can be locked in the **O (OFF)** position to allow work to be carried out with the power off in accordance with installation rules. The circuit breaker can only be locked in the open position if the circuit breaker is in the **O (OFF)** position.

NOTE: Locking a ComPacT NSX circuit breaker in the open position is sufficient to isolate the circuit breaker.

The locks depend on the type of actuator:

- For circuit breakers with toggle handles, refer to the locking accessories, page 33.
- For circuit breakers with rotary handles, refer to how to lock the circuit breaker with direct rotary handle, page 42 and how to lock the circuit breaker with extended rotary handle, page 47.
- For circuit breakers with motor mechanisms, refer to how to lock the circuit breaker, page 58.

Maintenance and Servicing Work on Installation

DANGER

HAZARD OF ELECTRIC SHOCK, EXPLOSION, OR ARC FLASH

- Apply appropriate personal protective equipment (PPE) and follow safe electrical work practices. See NFPA 70E or CSA Z462 or local equivalent.
- This equipment must only be installed and serviced by qualified electrical personnel.
- Turn off all power supplying this equipment before working on or inside equipment.
- Always use a properly rated voltage sensing device to confirm that power is off.
- Put back all devices, doors, and covers before turning on power to this equipment.
- Repair the installation immediately if an insulation fault occurs during operation.

Failure to follow these instructions will result in death or serious injury.

Turn off all power supplying the equipment before working on or inside equipment. For a partial powering down of the installation, the installation and safety rules require clearly labeling and isolating the feed being worked on.

Maintenance Work Following Fault Trip

⚠ WARNING
<p>HAZARD OF CLOSING ON ELECTRICAL FAULT</p> <p>Do not close the circuit breaker again without first inspecting and, if necessary, repairing the downstream electrical equipment.</p> <p>Failure to follow these instructions can result in death, serious injury, or equipment damage.</p>

The fact that a protection has tripped does not remedy the cause of the fault detected on the downstream electrical equipment.

The following table describes the procedure to be followed after a fault trip:

Step	Action
1	Isolate the feed before inspecting the downstream electrical equipment.
2	Look for the cause of the detected fault.
3	Inspect and, if necessary, repair the downstream equipment.
4	Inspect the equipment in the event of a short-circuit trip.
5	Close the circuit breaker again.

For more information about restarting following a fault, refer to Responding to a trip.

Checking the Settings

Checking settings does not require any particular precautions. The checks must be carried out by a qualified person.

Testing the Circuit Breaker

⚠ CAUTION
<p>HAZARD OF NUISANCE TRIPPING</p> <p>Protection tests must be done by qualified electrical personnel.</p> <p>Failure to follow these instructions can result in injury or equipment damage.</p>

When testing circuit breaker trip mechanisms, precautions must be taken:

- To avoid disrupting operations.
- To avoid inappropriate actions or tripping of alarms.

For example, tripping the circuit breaker with the push-to-trip button can lead to inappropriate fault indications or corrective actions (such as switching to a replacement power source).

Setting the Trip Unit

⚠ WARNING

HAZARD OF NUISANCE TRIPPING OR FAILURE TO TRIP

Protection setting adjustments must be done by qualified electrical personnel.

Failure to follow these instructions can result in death, serious injury, or equipment damage.

Modifying trip unit settings requires a thorough knowledge of the installation and safety rules.

Environmental Conditions

Ambient Temperature

The ambient temperature refers to the temperature of the air immediately surrounding the circuit breaker.

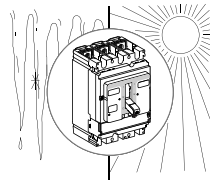

- Operation temperature: -25 °C to +70 °C (-13 °F to +158 °F)
NOTE: Commissioning is possible at -35 °C (-31 °F)
- Storage temperature: -50 °C to +85 °C (-58 °F to +185 °F)

Extreme Atmospheric Conditions

ComPacT NSX DC circuit breakers are designed to operate in industrial atmospheres as defined in standard IEC 60947-2 for the highest level of pollution (level 3).

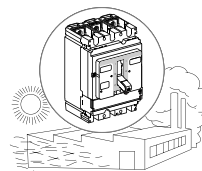

They are tested for extreme storage conditions according to the following standards:

Standard	Title
IEC 60068-2-2	Dry heat, severity level +85 °C (+185 °F)
IEC 60068-2-1	Dry cold, severity level -55 °C (-67 °F)
IEC 60068-2-30	Damp heat, cyclic <ul style="list-style-type: none"> • temperature +55 °C (+131 °F) • relative humidity 95%
IEC 60068-2-52	Salt-mist test

To obtain the best use from the circuit breakers, install them in properly ventilated switchboards where excessive dust is not a problem.

Vibration

ComPacT NSX DC circuit breakers are tested against vibration.

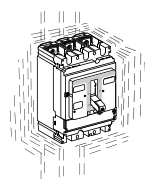

Conformity tests are carried out in accordance with standard IEC 60068-2-6 at the levels of severity required by the merchant shipping regulatory bodies (IACS, Veritas, Lloyd namely):

- 2 Hz to 13.2 Hz with an amplitude of +/- 1 mm (+/- 0.04 in)
- 13.2 Hz to 100 Hz at a constant acceleration of 0.7 g

Electromagnetic Disturbances

ComPacT NSX DC circuit breakers are immune to electromagnetic disturbance.

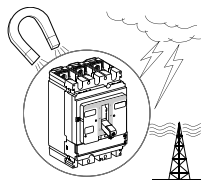

They comply with the requirements of the electromagnetic compatibility (EMC) standard IEC 60947-2 Appendixes F and J - Overcurrent protection tests.

Check for compliance with EMC standards by testing for immunity to:

- Overvoltages produced by the operation of electromagnetic circuit breaker
- Overvoltages produced by atmospheric disturbance that pass through the electrical network (for example, lightning)
- The use of apparatus emitting radio waves (such as radio transmitters, walkie-talkies, or radar)
- Electrostatic discharges produced by the operators themselves

Conformity with EMC standards as described above helps to ensure that:

- The circuit breaker operates correctly in a disturbed environment
 - without nuisance tripping
 - in accordance with the trip time.
- There is no disturbance to any type of industrial or commercial environment.

Altitude

ComPacT NSX DC circuit breakers are designed to operate within specification at altitudes of up to 2,000 m (6,600 ft).

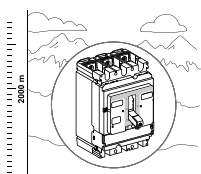

Operation above 2,000 m (6,600 ft) modifies the characteristics of the surrounding air (dielectric strength, cooling capacity) and requires derating.

Altitude derating table for ComPacT NSX DC circuit breakers:

Altitude (m/ft)	< 2,000 m	3,000 m	4,000 m	5,000 m
	(6,600 ft)	(9,800 ft)	(13,000 ft)	(16,500 ft)
Impulse withstand voltage U _{imp} (kV)	8	7.1	6.4	5.6
Rated insulation voltage U _i (V)	750	710	635	560
Maximum rated operational DC voltage (V)	ComPacT NSX DC ≤ 250 V	250	220	200
	ComPacT NSX DC 250–500 V	500	440	400
	ComPacT NSX DC 500–750 V	750	660	600
Rated current (A)	I _n	0.96 x I _n	0.93 x I _n	0.90 x I _n

Altitude derating table for ComPacT NSX DC PV circuit breakers:

Altitude (m/ft)	< 2,000 m	3,000 m	4,000 m	5,000 m
	(6,600 ft)	(9,800 ft)	(13,000 ft)	(16,500 ft)
Impulse withstand voltage U _{imp} (kV)	8	7.1	6.4	5.6
Rated insulation voltage U _i (V)	1,000	900	800	700
Maximum rated operational DC voltage (V)	1,000	900	800	700
Rated current (A)	I _n	0.96 x I _n	0.93 x I _n	0.90 x I _n

Altitude derating table for ComPacT NSX DC EP circuit breakers:

Altitude (m/ft)	< 2,000 m	3,000 m	4,000 m	5,000 m
	(6,600 ft)	(9,800 ft)	(13,000 ft)	(16,500 ft)
Impulse withstand voltage U _{imp} (kV)	8	7.1	6.4	5.6
Rated insulation voltage U _i (V)	1,600	1,400	1,250	1,100
Maximum rated operational DC voltage (V)	1,500	1,300	1,150	1,000
Rated current (A)	I _n	0.96 x I _n	0.93 x I _n	0.90 x I _n

Circuit Breaker With Toggle Handle

What's in This Chapter

Front Face Description	28
Opening, Closing, and Resetting the Circuit Breaker	29
Testing the Circuit Breaker	31
Locking the Circuit Breaker	33

Front Face Description

Front Face

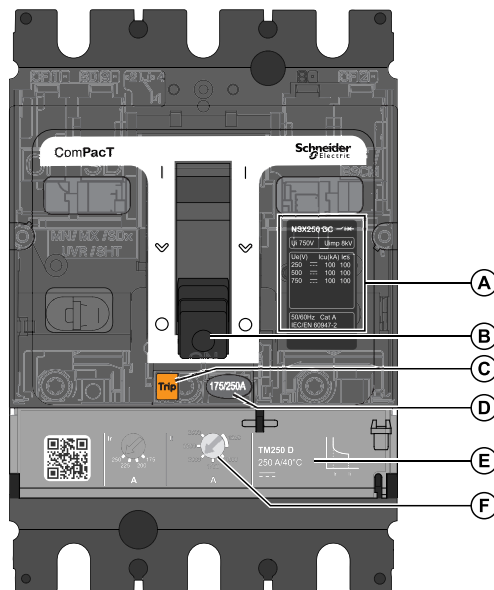

- A** Faceplate
- B** Toggle handle for opening, closing, and resetting
- C** Push-to-trip button
- D** Circuit breaker rating
- E** Trip unit (circuit breaker only)
- F** Trip unit adjustment dials (circuit breaker only)

For more information about installation, refer to the instruction sheets, page 7.

Opening, Closing, and Resetting the Circuit Breaker

Opening and Closing Locally

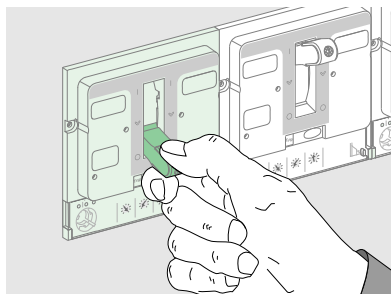

- To close the circuit breaker, move the toggle handle from the **O (OFF)** position to the **I (ON)** position.
- To open the circuit breaker, move the toggle handle from the **I (ON)** position to the **O (OFF)** position.

Resetting After a Trip on Electrical Fault

The circuit breaker has tripped on electrical fault, the toggle handle has moved from the **I (ON)** position to the Trip **∨** position.

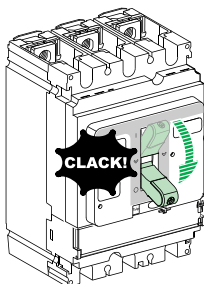

⚠ WARNING

HAZARD OF CLOSING ON ELECTRICAL FAULT

Do not close the circuit breaker again without first inspecting and, if necessary, repairing the downstream electrical equipment.

Failure to follow these instructions can result in death, serious injury, or equipment damage.

The fact that a circuit breaker has tripped does not remedy the cause of the fault detected on the downstream electrical equipment.

To reset after a fault trip:

Step	Action	Position
1	–	∨
2	–	∨
3	–	∨
4	–	∨

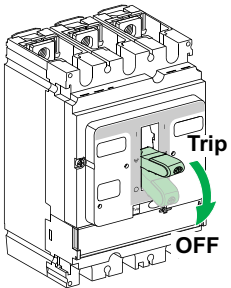
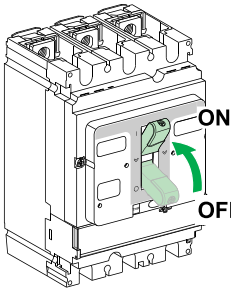
Step	Action		Position
5		<p>Reset the circuit breaker by moving the toggle handle to O (OFF).</p>	<p>O (OFF)</p>
6		<p>Close the circuit breaker by moving the toggle handle to I (ON).</p>	<p>I (ON)</p>

Testing the Circuit Breaker

Push-to-Trip Procedure

⚠ CAUTION

HAZARD OF NUISANCE TRIPPING

Device tests must only be done by qualified electrical personnel.

Failure to follow these instructions can result in injury or equipment damage.

When testing the trip mechanism take precautions against:

- Disrupting operations
- Activating inappropriate alarms
- Triggering unwanted actions

For example, tripping the circuit breaker with the push-to-trip button can lead to inappropriate fault indications or corrective actions (such as switching to an alternate power source).

Follow these steps to test the trip mechanism:

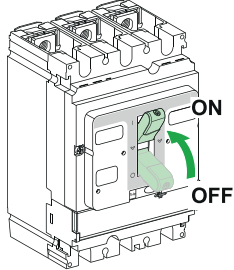
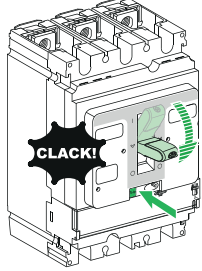
Step	Action		Position
1		Close the circuit breaker.	I (ON)
2		Press the push-to-trip button to trip the circuit breaker.	☑

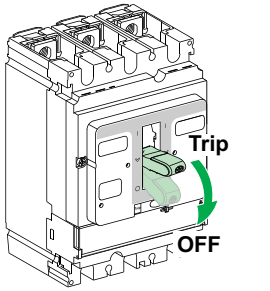
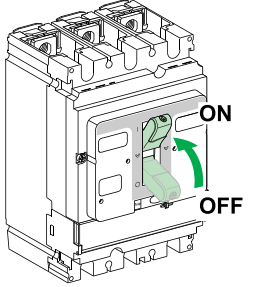
Step	Action		Position
3		<p>Reset the circuit breaker by moving the toggle handle to O (OFF).</p>	<p>O (OFF)</p>
4		<p>Close the circuit breaker by moving the toggle handle to I (ON).</p>	<p>I (ON)</p>

Locking the Circuit Breaker

Locking Accessories

⚠️⚠️ DANGER

HAZARD OF ELECTRIC SHOCK, EXPLOSION, OR ARC FLASH

When the circuit breaker toggle handle is locked in the **(O) OFF** position, always use a properly rated voltage sensing device to confirm that power is off before working on equipment.

Failure to follow these instructions will result in death or serious injury.

Use locking accessories to lock the toggle handle in the **I (ON)** or **O (OFF)** position.

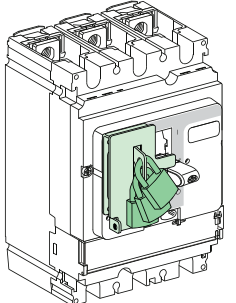
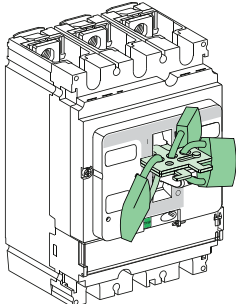
Accessory		Padlocks
	Accessory that is part of the case	Use up to 3 padlocks (not supplied) 5–8 mm (0.2–0.3 in) in diameter
	Accessory that is detachable	Use up to 3 padlocks (not supplied) 5–8 mm (0.2–0.3 in) in diameter

NOTE: Locking the toggle handle in the **I (ON)** position does not disable the circuit breaker protection functions. If there is an electrical fault, the circuit breaker trips without altering its performance. When unlocked, the toggle handle moves to the **Trip** position. To return the circuit breaker to service, refer to how to open, close, and reset the circuit breaker, page 29.

Sealing Accessories

Use sealing accessories to prevent circuit breaker operations.

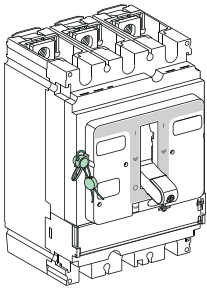
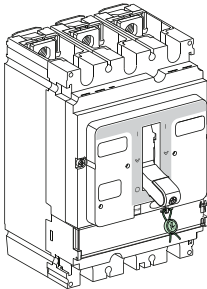
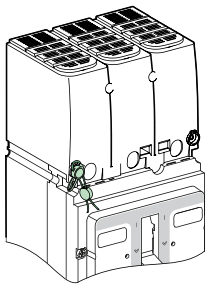
Seal		Prohibited operations
	Escutcheon mounting screw	<ul style="list-style-type: none"> • Dismantling the escutcheon • Accessing the auxiliaries • Dismantling the trip unit
	Transparent protective cover	<ul style="list-style-type: none"> • Altering trip unit settings • Accessing the test port for the trip units
	Mounting screw for terminal shields	Accessing the power connection (protection against direct contact)

Circuit Breaker With Rotary Handle

What's in This Chapter

Front Face Description	36
Opening, Closing, and Resetting the Circuit Breaker	38
Testing a Circuit Breaker With Direct Rotary Handle	40
Locking a Circuit Breaker With Direct Rotary Handle	42
Testing a Circuit Breaker With Extended Rotary Handle.....	45
Locking a Circuit Breaker With Extended Rotary Handle.....	47

Front Face Description

Front Face with Direct Rotary Handle

The circuit breaker operating controls, operation indicators, settings, and locking mechanisms for the direct rotary handle are on the front of the circuit breaker.

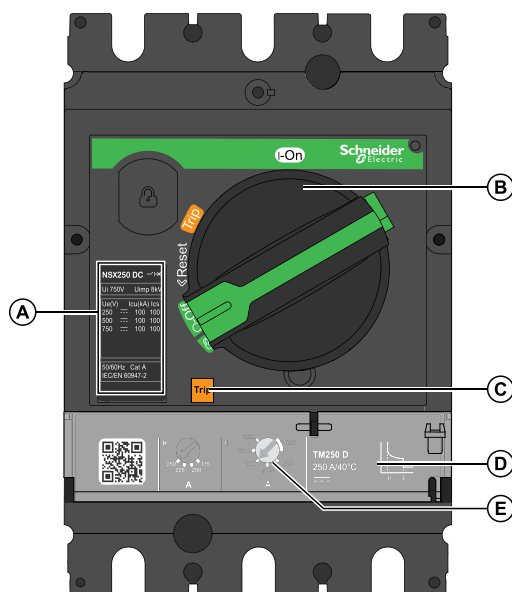

A Faceplate

B Direct rotary handle for opening, closing, and resetting

C Push-to-trip button

D Trip unit (circuit breaker only)

E Trip unit adjustment dials (circuit breaker only)

For more information about rotary handle configuration and installation, consult the following instruction sheets:

- NNZ4765907 Direct rotary handle for ComPacT NSX100-250 DC
- NNZ4766407 Direct rotary handle for ComPacT NSX400-630 DC

Front Face with Extended Rotary Handle

For circuit breakers with an extended rotary handle:

- The circuit breaker operating controls are on the door escutcheon.
- The operation indicators and settings are only accessible when the door is open
- The locking mechanisms, page 47 are on the circuit breaker (optional) and on the door escutcheon (door closed).

There are two models of extended rotary handle:

- Black handle for standard applications
- Red handle on yellow bezel for machine control applications

Cabinet door open

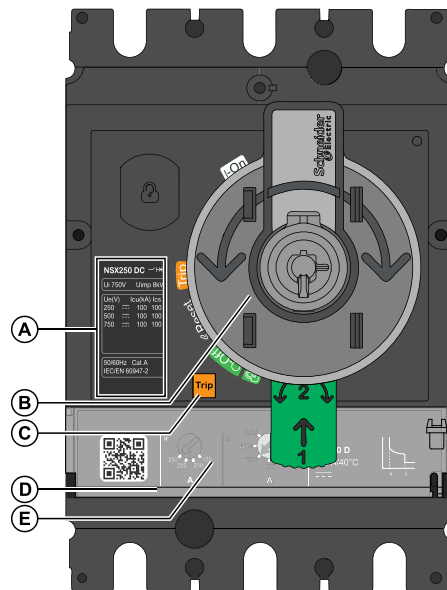

Cabinet door closed

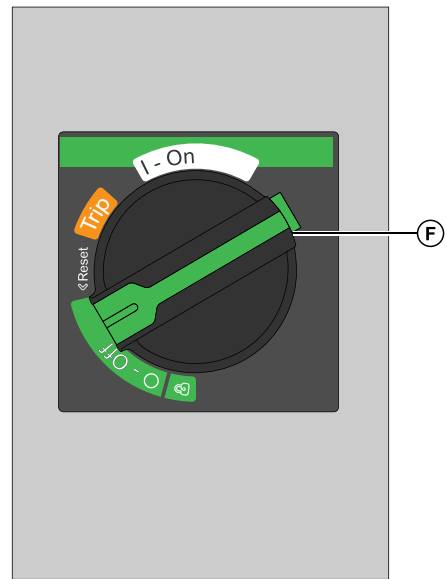

A Faceplate

B Open door shaft operator

C Push-to-trip button

D Trip unit

E Trip unit adjustment dials

F Extended rotary handle for opening, closing, and resetting

For more information about extended rotary handle installation, consult the instruction sheets on the Schneider Electric website:

For more information about extended rotary handle installation, consult the following instruction sheets:

- NNZ4766007 Extended rotary handle for ComPacT NSX100-250 DC
- NNZ4766507 Extended rotary handle for ComPacT NSX400-630 DC

Rotary Handle and Accessories Installation Demonstration Video

For information about installation of ComPacT NSX DC circuit breakers, consult the ComPacT NSX100–250 circuit breakers installation video. To access the video, click the following link: <https://youtu.be/h7ETxmroxil>, or copy and paste the link to your Web browser.

Opening, Closing, and Resetting the Circuit Breaker

Opening and Closing Locally

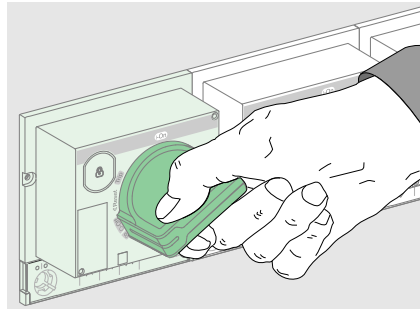

- To close the circuit breaker, turn the rotary handle clockwise from the **O (OFF)** position to the **I (ON)** position.
- To open the circuit breaker, turn the rotary handle counterclockwise from the **I (ON)** position to the **O (OFF)** position.

Resetting After a Trip on Electrical Fault

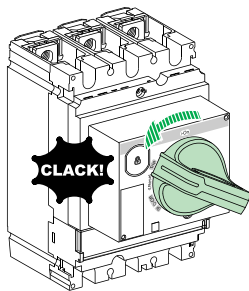

The circuit breaker has tripped on electrical fault, the rotary handle has moved from the **I (ON)** position to the **Trip** position.

⚠ WARNING
HAZARD OF CLOSING ON ELECTRICAL FAULT
Do not close the circuit breaker again without first inspecting and, if necessary, repairing the downstream electrical equipment.
Failure to follow these instructions can result in death, serious injury, or equipment damage.

The fact that a circuit breaker has tripped does not remedy the cause of the fault detected on the downstream electrical equipment.

To reset after a fault trip:

Step	Action	Position
1	– Isolate the feed, page 21 before inspecting the downstream electrical equipment.	Trip
2	– Look for the cause of the detected fault.	Trip
3	– Inspect and, if necessary, repair the downstream equipment.	Trip
4	– Inspect the equipment in the event of a short-circuit trip.	Trip

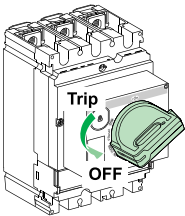
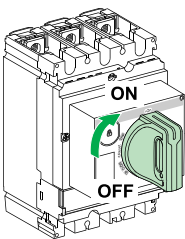
Step	Action	Position
5	 <p>Reset the circuit breaker by turning the rotary handle counterclockwise from the Trip position to O (OFF).</p>	O (OFF)
6	 <p>Close the circuit breaker by turning the rotary handle clockwise to I (ON).</p>	I (ON)

Testing a Circuit Breaker With Direct Rotary Handle

Push-to-Trip Procedure

⚠ CAUTION

HAZARD OF NUISANCE TRIPPING

Device tests must only be done by qualified electrical personnel.

Failure to follow these instructions can result in injury or equipment damage.

When testing the trip mechanism, take precautions against:

- Disrupting operations
- Activating inappropriate alarms
- Triggering unwanted actions

For example, tripping the circuit breaker with the push-to-trip button can lead to inappropriate fault indications or corrective actions (such as switching to an alternate power source).

Follow these steps to test the trip mechanism:

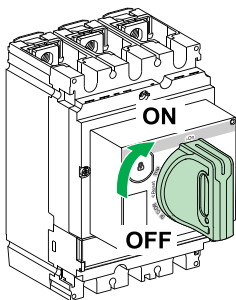
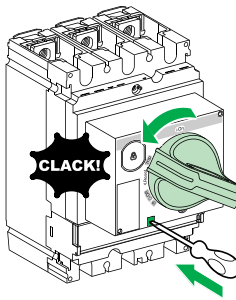
Step	Action	Position
1		Close the circuit breaker. I (ON)
2		Press the push-to-trip button: the circuit breaker trips. Trip

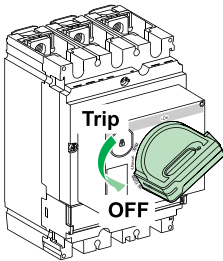
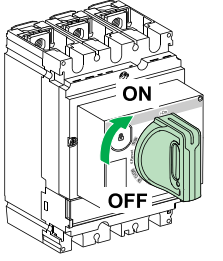
Step	Action	Position
3		Reset the circuit breaker by turning the rotary handle counterclockwise from the Trip position to O (OFF) .
4		Close the circuit breaker by turning the rotary handle clockwise to I (ON) .

Locking a Circuit Breaker With Direct Rotary Handle

Locking Accessories

Lock handle with up to three padlocks (not supplied) or a keylock.

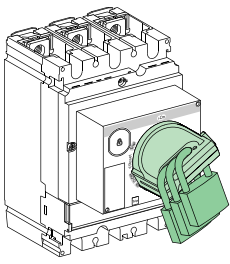
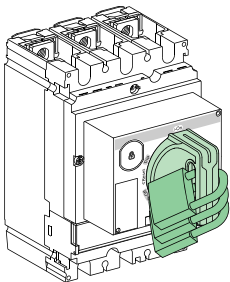
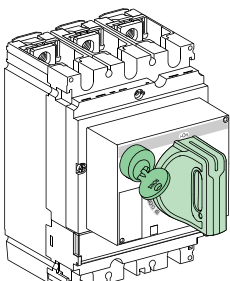
Accessory		Padlocks
	<p>Padlocking (standard) only in the O (OFF) position.</p>	<p>Lock handle with up to three padlocks (not supplied) with shackle diameters of 5–8 mm (0.2–0.3 in).</p>
	<p>Padlocking (after modification to the rotary handle during installation) in the two positions I (ON) and O (OFF).</p>	<p>Lock handle with up to three padlocks (not supplied) with shackle diameters of 5–8 mm (0.2–0.3 in).</p>
	<p>Keylocking with a Profalux® or Ronis® lock (optional).</p> <p>The circuit breaker can be locked in the O (OFF) position only or in the O (OFF) and I (ON) position, depending on the bolt chosen.</p>	<p>A Profalux or Ronis lock can be installed on site.</p> <p>Keylocking can be used at the same time as padlocking.</p>

NOTE: Locking the rotary handle in the **I (ON)** position does not disable the circuit breaker protection functions. If there is an electrical fault, the circuit breaker still trips. When unlocked, the handle moves to the **Trip** position. To return the circuit breaker to service, follow the [resetting instructions](#), page 38.

Door Locking (MCC Function)

Further options are offered with the direct rotary handle in the MCC function.

When the circuit breaker is in the **I (ON)** position, the direct rotary handle locks the door in the closed position.

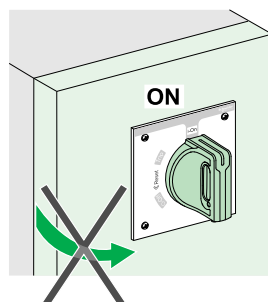

⚠ ⚠ DANGER**HAZARD OF ELECTRIC SHOCK, EXPLOSION, OR ARC FLASH**

Only qualified persons are authorized to disable the door lock.

Failure to follow these instructions will result in death or serious injury.

Temporarily disable this lock to open the door when the circuit breaker is in the I (ON) position.

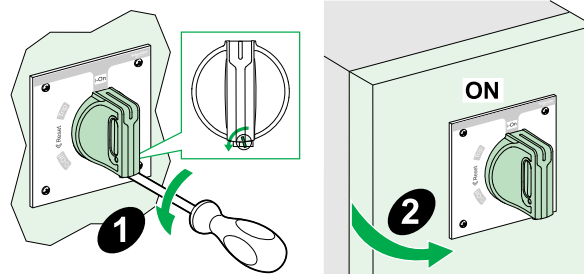

Disabling this lock requires modifying the rotary handle. Consult the instruction sheet NNZ4766107 *MCC conversion accessory for ComPacT NSX100–630*.

If the lock has been disabled, the following direct rotary handle functions are inoperative:

- Door locking
- Preventing the circuit breaker from being closed when the door is open

Preventing Circuit Breaker Closing When the Door Is Open

The door locking device can also help to prevent the direct rotary handle from being moved to the I (ON) position when the door is open.

Sealing Accessories

Use sealing accessories to prevent circuit breaker operations.

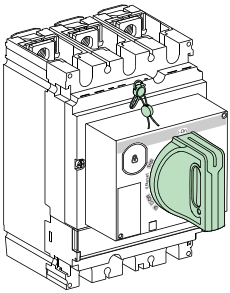
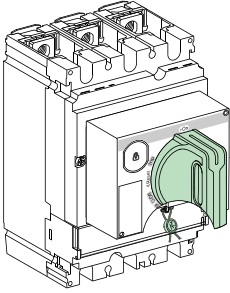
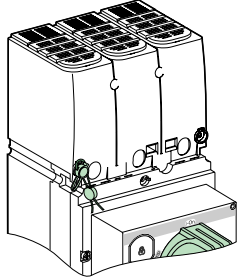
Seal		Prohibited operations
	<p>Escutcheon mounting screw</p>	<ul style="list-style-type: none"> • Dismantling the escutcheon • Accessing the auxiliaries • Dismantling the trip unit
	<p>Transparent protective cover</p>	<ul style="list-style-type: none"> • Altering trip unit settings • Accessing the test port for the trip units
	<p>Mounting screw for terminal shields</p>	<p>Accessing the power connection (protection against direct contact)</p>

Testing a Circuit Breaker With Extended Rotary Handle

Push-to-Trip Procedure

⚠ CAUTION
HAZARD OF NUISANCE TRIPPING
Device tests must only be done by qualified electrical personnel.
Failure to follow these instructions can result in injury or equipment damage.

When testing the trip mechanism take precautions against:

- Disrupting operations
- Activating inappropriate alarms
- Triggering unwanted actions

For example, tripping the circuit breaker with the push-to-trip button can lead to inappropriate fault indications or corrective actions (such as switching to an alternate power source).

There is no push-to-trip button on the door of a circuit breaker with a front extended rotary handle. To check the trip mechanism, the door must first be opened.

Follow these steps to test the trip mechanism:

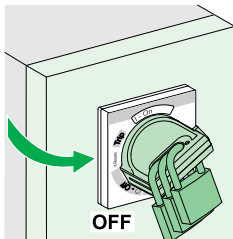
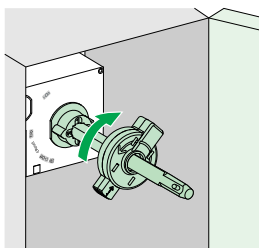
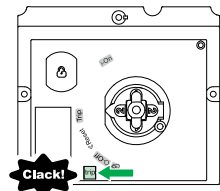
Step	Action	Position
1		<p>Switch the circuit breaker to the open O (OFF) position. Open the door.</p> <p>O (OFF)</p>
2		<p>Turn the circuit breaker from the O (OFF) position to the I (ON) position, using one of the following tools:</p> <ul style="list-style-type: none"> • An open door shaft operator (LV426937). • A flat wrench, taking care not to damage the extension shaft or its surface treatment. The extension shaft is a solid square section shaft, 10 x 10 mm (0.39 x 0.39 in). <p>The circuit breaker is ready for the test.</p>
3		<p>Press the push-to-trip button. The circuit breaker trips.</p> <p>Trip</p>

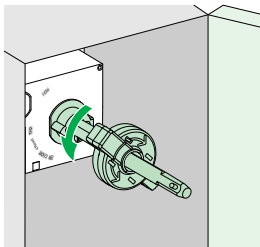
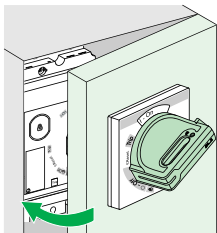
Step	Action	Position
4		<p>Use a specific tool (refer to step 2) to turn the extension shaft counterclockwise and switch the circuit breaker from the Trip position to the O (OFF) position. The circuit breaker is in the open position.</p> <p>O (OFF)</p>
5		<p>Close the door.</p> <p>—</p>

Locking a Circuit Breaker With Extended Rotary Handle

Locking Accessories

The extended rotary handle offers several locking functions to:

- Prevent the rotary handle being operated.
- Prevent the door being opened.

Some locking functions can be disabled on different adaptations.

The handle can be locked with up to three padlocks (not supplied) or keylock.

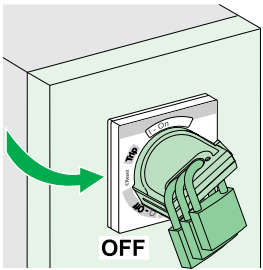
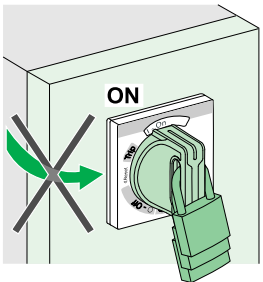
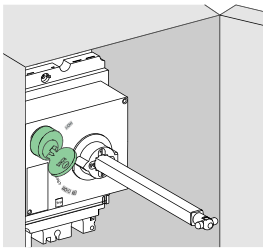
Accessory		Padlocks
	<p>Padlocking (standard) in the O (OFF) position.</p> <p>Padlocking the rotary handle in the O (OFF) position does not prevent the door from opening.</p>	<p>Lock rotary handle with up to three padlocks (not supplied) with shackle diameters of 5–8 mm (0.2–0.3 in).</p>
	<p>Padlocking (after modification to the rotary handle during installation) in the two positions I (ON) and O (OFF).</p> <p>There is a choice of two options when locking the rotary handle in the I (ON) position:</p> <ul style="list-style-type: none"> • Standard with the door opening locked. • As an option, door is not interlocked, and locking the rotary handle does not stop the door from opening. 	<p>Lock rotary handle with up to three padlocks (not supplied) with shackle diameters of 5–8 mm (0.2–0.3 in).</p>
	<p>Keylocking with a Profalux® or Ronis® lock (optional).</p> <p>The lock is mounted on the case inside the switchboard.</p> <p>Lock the circuit breaker in the O (OFF) position only or in the O (OFF) and I (ON) positions depending on the bolt chosen.</p>	<p>A Profalux or Ronis lock can be installed on site. Keylocking can be used at the same time as padlocking.</p>

NOTE: Locking the rotary handle in the **I (ON)** position does not disable the circuit breaker protection functions. If there is an electrical fault, the circuit breaker still trips. When unlocked, the rotary handle moves to the **Trip** position. To return the circuit breaker to service, follow the resetting instructions, page 38.

Door Locking (MCC Function)

The extended rotary handle locks the door in the **I (ON)** position as standard.

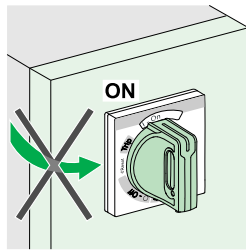

⚡ ⚠ DANGER

HAZARD OF ELECTRIC SHOCK, EXPLOSION, OR ARC FLASH

Only qualified persons are authorized to disable the door lock.

Failure to follow these instructions will result in death or serious injury.

Temporarily disable this lock to open the door when the circuit breaker is in the **I (ON)** position.

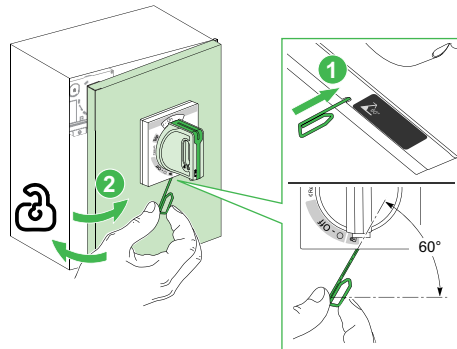

The rotary handle is delivered with the door lock activated. To deactivate the lock, consult the instruction sheets:

- NNZ4766007, *Extended rotary handle for ComPacT NSX100-250*
- NNZ4766507, *Extended rotary handle for ComPacT NSX400-630*

Example: An application includes a circuit breaker for a switchboard incoming supply and several receiver circuit breakers with extended rotary handles installed behind the same door. Locking the door with a single rotary handle (incoming supply circuit breaker) simplifies maintenance work on the switchboard.

Key-Operated Locking Procedure

Keylocking can be done with circuit breaker in either the **O (OFF)** position or the **I (ON)** position.

Step	Action (circuit breaker in the O (OFF) position)	Action (circuit breaker in the I (ON) position)
1	Open the door.	Open the door by disabling the door locking device if necessary.
2	Use the keylock mounted on the case inside the switchboard to lock the rotary handle.	Use the keylock mounted on the case inside the switchboard to lock the rotary handle.
3	Close the door.	Close the door, disabling the door locking device if necessary.

Sealing Accessories

The sealing accessories, page 42 for circuit breakers with extended rotary handles are identical to those for circuit breakers with direct rotary handles.

Motor-Operated Circuit Breakers

What's in This Chapter

Front Face Description	51
Opening, Closing, and Resetting a Circuit Breaker With Motor Mechanism	53
Opening, Closing, and Resetting Circuit Breakers With Communicating Motor Mechanism.....	57
Locking the Circuit Breaker	58

Front Face Description

Front Face

The main controls, operation indicators, settings, and locking mechanisms are on the front of an electrically operated circuit breaker (with motor mechanism).

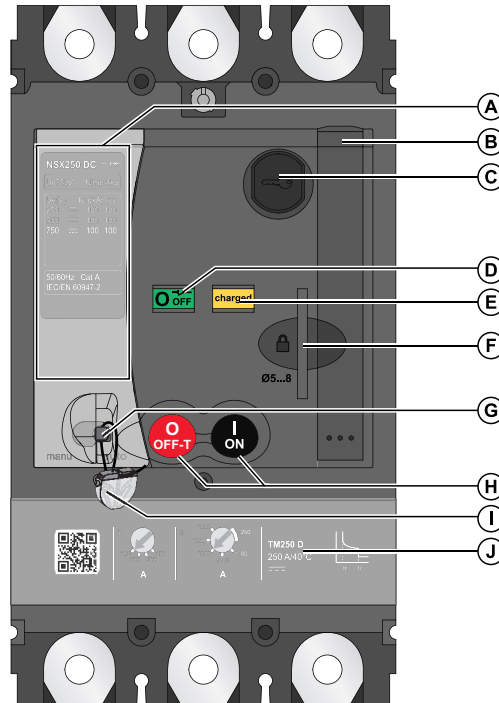

- A. Faceplate
- B. Charging handle
- C. Keylocking in **O (OFF)** position
- D. Main contacts position indicator
- E. Spring-charged and ready-to-close indicator
- F. Padlocking in **O (OFF)** position
- G. Manual/automatic operating mode selector
- H. Closing (**I**) and opening (**O**) pushbuttons
- I. Sealing accessory
- J. Trip unit (circuit breaker only)

For more information about motor mechanism installation, consult the instruction sheets on the Schneider Electric website:

- BQT6157604 ComPacT NSX100-250 Motor Mechanism
- BQT6157605 ComPacT NSX400-630 Motor Mechanism

NOTE: The motor mechanism cannot be installed on a ComPacT NSX DC EP circuit breaker.

Main Contacts Position Indicator

Indicator	Description
	The circuit breaker is closed.
	The circuit breaker is open or tripped.

NOTE: Use the SD or SDE switch to distinguish the **Trip** position from the **O (OFF)** position.

Control Charge Indicator

Indicator	Description
	Stored energy control charged
	Stored energy control discharged

NOTE: Stored energy control only provides the necessary energy to close the circuit breaker. The circuit breaker mechanism supplies the energy for tripping.

Manu/Auto Selector

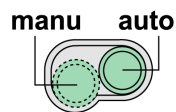

The Manu/Auto button selects the operating mode:

- In manual operating mode, all electrical commands are disabled.
- In automatic operating mode, only electrical commands are executed.

NOTE: The opening (**O (OFF-T)**) pushbutton can be used to open the ComPacT NSX DC circuit breakers in automatic and in manual operating modes.

Opening, Closing, and Resetting a Circuit Breaker With Motor Mechanism

Introduction

The motor mechanism can open and close a circuit breaker remotely with electrical commands. There are many applications:

- Automation of electrical distribution to optimize operating costs
- Normal/standby source changeover: changes over to a replacement source to improve continuity of service
- Load shedding/reconnection to optimize tariff-based contracts

⚠ CAUTION

HAZARD OF REPEATED CLOSING ON ELECTRICAL FAULT

Do not modify the wiring diagrams for the motor mechanism.

Failure to follow these instructions can result in injury or equipment damage.

Wire the motor mechanism in strict accordance with the motor mechanism wiring diagram in the appendix.

In automatic operating mode, wiring the SDE contact helps to prevent the circuit breaker from resetting automatically on an electrical fault. For more information about the SDE contact, refer to the indication contacts.

Manual Operation: Opening, Closing, and Resetting Locally

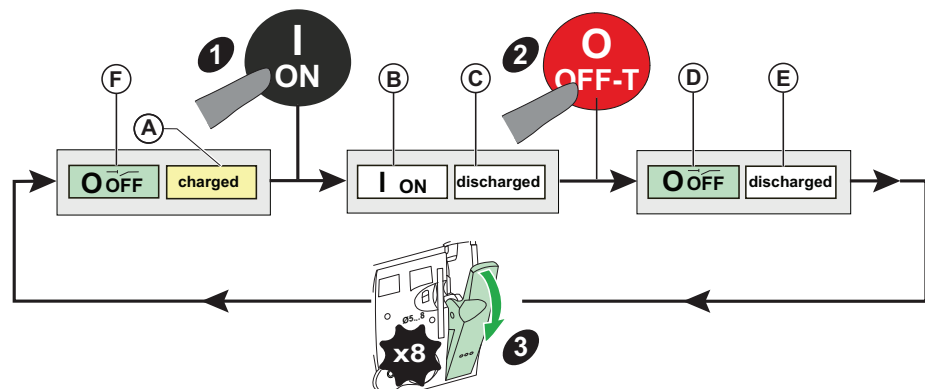

Move the selector to the **Manu** position.

Cycle of operation:



Manual Operation Description

Check that the spring-charged indicator is on **charged (A)**. If not, reset the circuit breaker.

Step	Action	Comment
1	Close the circuit breaker by pressing the closing pushbutton  .	When the circuit breaker is closed: <ul style="list-style-type: none"> The contact position indicator (B) changes to I (ON). The spring-charged indicator (C) changes to discharged.
2	Open the circuit breaker by pressing the opening pushbutton  .	When the circuit breaker is open: <ul style="list-style-type: none"> The contact position indicator (D) changes to O (OFF). The spring-charged indicator (E) stays on discharged.
3	Reset the circuit breaker: recharge the closing spring by operating the charging handle (eight times).	When the circuit breaker is ready to be closed: <ul style="list-style-type: none"> The contact position indicator (F) stays on O (OFF). The spring-charged indicator (A) changes to charged.

Automatic Operation: Opening, Closing, and Resetting Remotely

Move the selector to the **Auto** position.

Cycle of operation:

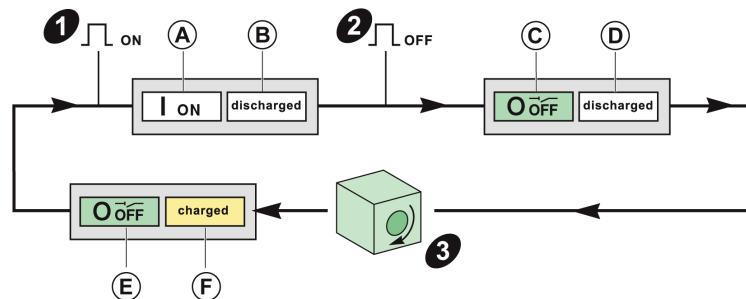

Automatic Operation Description

Step	Action	Comment
1	Close the circuit breaker by sending a close (ON) command.	When the circuit breaker is closed: <ul style="list-style-type: none"> The contact position indicator (A) changes to I (ON). The spring-charged indicator (B) changes to discharged.
2	Open the circuit breaker: <ul style="list-style-type: none"> By sending an open (OFF) command. By pressing the opening pushbutton . 	When the circuit breaker is open: <ul style="list-style-type: none"> The contact position indicator (C) changes to O (OFF). The spring-charged indicator (D) stays on discharged.
3	Recharge the stored energy control by using one of the three reset modes, depending on the wiring diagram: <ul style="list-style-type: none"> Automatic reset Remote reset by using the pushbutton Manual reset by operating the charging handle 	The circuit breaker is ready to be closed: <ul style="list-style-type: none"> The contact position indicator (E) stays on O (OFF). The spring-charged indicator (F) changes to charged.

Resetting After a Trip on Electrical Fault

Resetting after a trip on electrical fault can only be done locally. When operating in automatic mode, return to manual operation to reset the circuit breaker.

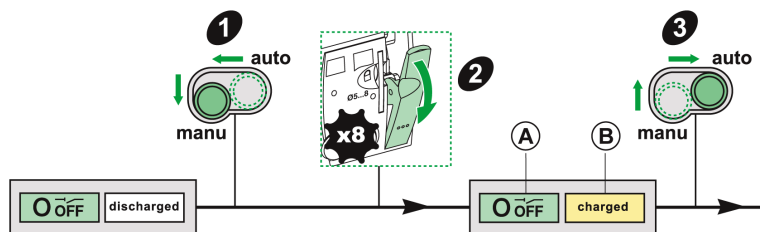

⚠ WARNING

HAZARD OF CLOSING ON ELECTRICAL FAULT

Do not close the circuit breaker again without first inspecting and, if necessary, repairing the downstream electrical equipment.

Failure to follow these instructions can result in death, serious injury, or equipment damage.

The fact that a protection has tripped the circuit breaker does not remedy the cause of the fault detected on the downstream electrical equipment.

To reset after a fault trip:

Step	Action
1	Isolate the feed, page 21 before inspecting the downstream electrical equipment.
2	With selector on Manu , operate the charging handle 8 times to reset the circuit breaker in ready-to-close position. Result: The spring-charged indicator changes to charged (B) and the internal mechanism goes from the Trip position to the O (OFF) position (A).
3	Lock the circuit breaker.
4	Look for the cause of the detected fault.
5	Inspect and, if necessary, repair the downstream equipment.

Step	Action
6	Inspect the equipment in the event of a short-circuit trip.
7	Reset and close the circuit breaker.

Opening, Closing, and Resetting Circuit Breakers With Communicating Motor Mechanism

Introduction

The communicating motor mechanism can open and close a circuit breaker remotely, with remote commands via the communication network.

For this function, use a communicating motor mechanism and a BSCM Modbus SL/ULP module.

Connect the BSCM Modbus SL/ULP module to the communication network:

- To receive closing, opening, and reset commands from the circuit breaker.
- To transmit the circuit breaker states: **O (OFF)**, **I (ON)**, Tripped by SDE.

NOTE: The communicating motor mechanism has a specific reference (refer to LVPED221002EN *ComPacT NSX, ComPacT INS/INV, MasterPacT NW DC - DC PV Catalog*, page 7).

The schematic for the communicating motor mechanism in the BSCM Modbus SL/ULP module can be configured with *EcoStruxure Power Commission software*, page 19. It must be created in strict accordance with the simplified motor mechanism schematic.

▲ CAUTION

HAZARD OF REPEATED CLOSING ON ELECTRICAL FAULT

Do not modify the wiring diagrams for the motor mechanism.

Failure to follow these instructions can result in injury or equipment damage.

Manual Operation: Opening, Closing, and Resetting Locally

The process is the same as the standard motor mechanism, page 53.

Automatic Operation: Opening, Closing, and Resetting Remotely

The process is the same as the standard motor mechanism, page 54.

Resetting After a Trip on Electrical Fault

Without modifying the factory configuration, resetting after a trip on electrical fault can only be done locally, as for the standard motor mechanism, page 55.

For circuit breakers with communicating motor mechanism, it is possible to authorize remote reset. The reset mode of the communicating motor mechanism can be configured by using:

- EcoStruxure Power Commission software
- The communication network

For more information, refer to *Configuring the Communicating Motor Mechanism*, page 104.

Locking the Circuit Breaker

Locking Accessories

DANGER

HAZARD OF ELECTRIC SHOCK, EXPLOSION, OR ARC FLASH

When the circuit breaker toggle handle is locked in the **(O) OFF** position, always use a properly rated voltage sensing device to confirm that power is off before working on equipment.

Failure to follow these instructions will result in death or serious injury.

Lock the mechanism with up to three padlocks (not supplied) or a keylock.

Both locking methods can be used at the same time.

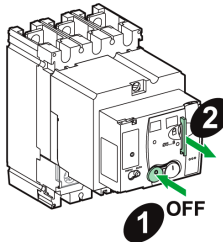
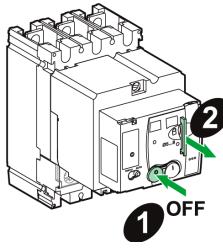
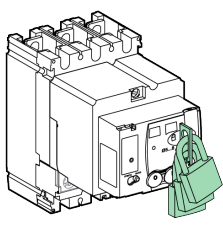
Step	Action	Comment	Result
1		Switch the circuit breaker to the O (OFF) position.	–
2		Pull out the tab	–
3		Lock the tab using: <ul style="list-style-type: none"> • Up to three padlocks 5-8 mm (0.2-0.3 in) in diameter. • A keylock (optional). 	The circuit breaker is locked. No commands in Auto mode or Manu mode are executed.

Sealing Accessories

Use sealing accessories to prevent circuit breaker operations.

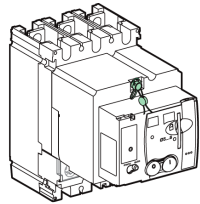
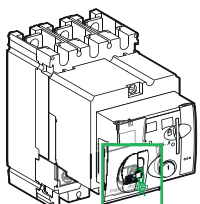
Seal		Prohibited operations
	Motor mechanism mounting screw	<ul style="list-style-type: none"> • Dismantling the escutcheon • Accessing the auxiliaries • Dismantling the trip unit
	Transparent cover for the motor mechanism	Accessing the manual/automatic selector (depending on its position, manual operation ⁽¹⁾ , or automatic operation is disabled).

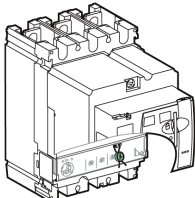
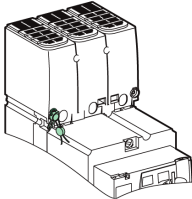
Seal		Prohibited operations
	<p>Transparent protective cover for the trip units</p>	<p>Altering any settings and accessing the test port.</p>
	<p>Mounting screw for terminal shields</p>	<p>Accessing the power connection (protection against direct contact)</p>
<p>(1) In this case no local operations are possible.</p>		

ComPacT NSX DC Installation Accessories

What's in This Part

Installation Accessories Summary	61
Plug-in Circuit Breaker	62
Withdrawable Circuit Breaker	66
Accessories	74

Installation Accessories Summary

Accessories for General-Purpose Applications

The following table shows the installation modes compatible with the ComPacT NSX DC circuit breakers for general-purpose applications. For further details, refer to LVPED221002EN *ComPacT NSX, ComPacT INS/INV, MasterPacT NW DC - DC PV Catalog*, page 7.

Installation Modes	NSX100 DC			NSX160 DC			NSX250 DC	NSX400 DC	NSX630 DC	NSX1200 DC
	1P	2P	3P/4P	1P	2P	3P/4P	3P/4P	3P/4P	3P/4P	2P
Fixed	✓	✓	✓	✓	✓	✓	✓	✓	✓	✓
Plug-in	–	✓	✓	–	✓	✓	✓	✓	✓	–
Withdrawable	–	✓	✓	–	✓	✓	✓	✓	✓	–

Accessories for Photovoltaic and Marine Applications

The following table shows the installation modes compatible with the ComPacT NSX DC circuit breakers for photovoltaic and marine applications. For further details, refer to LVPED221002EN *ComPacT NSX, ComPacT INS/INV, MasterPacT NW DC - DC PV Catalog*, page 7.

Installation Modes	NSX80-200 DC PV	NSX400-500 DC PV	NSX100-250 DC EP	NSX250-500 DC EP
	4P	4P	4P	4P
Fixed	✓	✓	✓	✓
Plug-in	–	–	–	–
Withdrawable	–	–	–	–

Plug-in Circuit Breaker

Introduction

Plug-in base circuit breakers make it possible to:

- Extract and/or rapidly replace the circuit breaker without having to touch the connections on the base.
- Allow for the addition of future circuits by installing bases that will be equipped with a circuit breaker at a later date.
- Isolate the power circuits when the circuit breaker is mounted on or through a panel. It acts as a barrier for the connections of the plug-in base. Insulation is made complete by the mandatory short terminal shields, page 65 on the circuit breaker.

The following types of circuit breaker can be installed in a plug-in base:

- 3P and 4P circuit breakers for general-purpose applications
- Circuit breakers with toggle handle, direct rotary handle, or extended rotary handle
- Motor-operated circuit breakers

The plug-in circuit breaker is made up of the fixed circuit breaker and a plug-in kit, which includes:

- Plug-in base
- Power connections
- Short terminal shields
- Safety trip interlock

For more information about plug-in circuit breaker installation, consult the instruction sheets on the Schneider Electric website:

- GHD16276AA, Plug-in base for ComPacT NSX100-250
- GHD16316AA, Plug-in base for ComPacT NSX400-630

Plug-in Kit and Chassis Installation Demonstration Video

For information about installation of ComPacT NSX DC circuit breakers, consult the ComPacT NSX100–250 circuit breakers installation video. To access the video, click the following link: <https://youtu.be/XaXO6QgeWvM>, or copy and paste the link to your Web browser.

Disconnecting the Circuit Breaker

⚡ ⚠ **DANGER**

HAZARD OF ELECTRIC SHOCK, EXPLOSION, OR ARC FLASH

- Apply appropriate personal protective equipment (PPE) and follow safe electrical work practices. See NFPA 70E, CSA Z462, NOM-029-STPS, or local equivalent.
- This equipment must only be installed and serviced by qualified electrical personnel.
- The circuit breaker must be in the **O (OFF)** position.
- Do not use tools to disconnect or connect the circuit breaker.

Failure to follow these instructions will result in death or serious injury.

Follow this procedure to disconnect the circuit breaker:

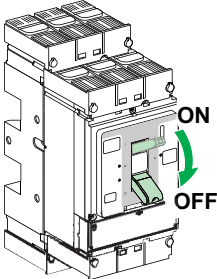
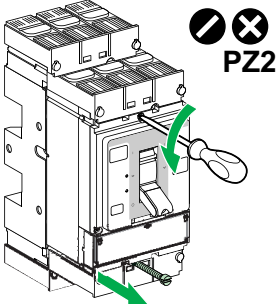
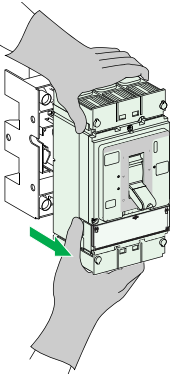
Step	Action	
1		Switch the circuit breaker to the O (OFF) position.
2		Remove both mounting screws.
3		Pull out the circuit breaker, keeping it horizontal.

NOTE:

- The auxiliary circuits automatically disconnect because of the connectors located on the base and at the rear of the circuit breaker.
- Open the circuit breaker before disconnecting it. If the circuit breaker is in the closed **I (ON)** position when disconnecting, a pre-trip mechanism trips the circuit breaker before the pins are disconnected.

Connecting the Circuit Breaker

⚡ ⚠ DANGER

HAZARD OF ELECTRIC SHOCK, EXPLOSION, OR ARC FLASH

- Apply appropriate personal protective equipment (PPE) and follow safe electrical work practices. See NFPA 70E, CSA Z462, NOM-029-STPS, or local equivalent.
- This equipment must only be installed and serviced by qualified electrical personnel.
- The circuit breaker must be in the **O (OFF)** position.
- Do not use tools to disconnect or connect the circuit breaker.

Failure to follow these instructions will result in death or serious injury.

Follow this procedure to connect the circuit breaker:

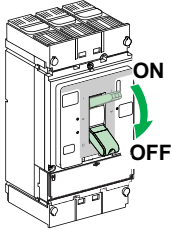
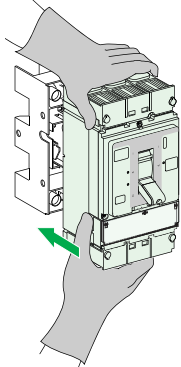
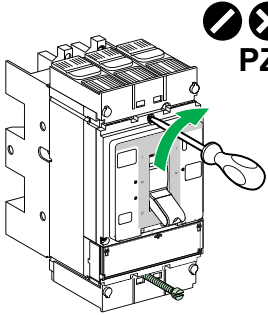
Step	Action
1	 <p>Switch the circuit breaker to the O (OFF) position.</p>
2	 <p>Connect the circuit breaker.</p>
3	 <p>Replace both mounting screws. Tighten the screws to a torque of 2.5 N•m (22.1 lb-in).</p>

NOTE:

- The auxiliary circuits automatically disconnect because of the connectors located on the base and at the rear of the circuit breaker.
- Open the circuit breaker before connecting it. If the circuit breaker is in the closed **I (ON)** position when connecting, the pre-trip mechanism trips it before the pins are connected.

Protection Against Direct Contact with Power Circuits

An adapter enables the base to take the same isolation and connection accessories as the unit-mount circuit breaker.

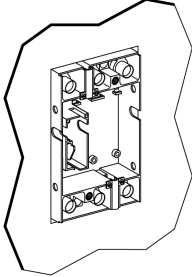
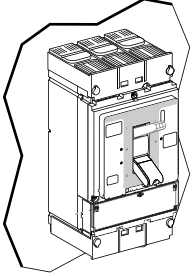
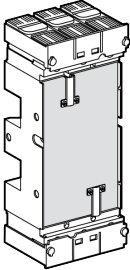
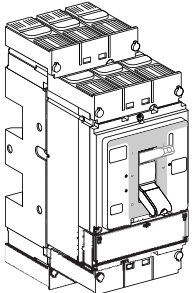
Configuration	Protection index	Description
	IP20	Built-in plug-in base: <ul style="list-style-type: none"> • Without circuit breaker • With circuit breaker without terminal shields
	IP40	Built-in plug-in base and circuit breaker with terminal shields.
	IP40	Plug-in base with adapter, terminal shields and blanking plate without circuit breaker: <ul style="list-style-type: none"> • The adapter enables the use of all the connection accessories of the fixed circuit breaker. It is required to equip the plug-in circuit breaker with long and short terminal shields and interphase barriers. • Terminal shields are mandatory for plug-in circuit breakers. Short terminal shields are supplied in the plug-in kit. They can be replaced by long terminal shields available as an option. • The blanking plate is not supplied by Schneider Electric.
	IP40	Plug-in base with adapter and terminal shields, and circuit breaker with terminal shields.

Withdrawable Circuit Breaker

Introduction

In addition to the advantages provided by a plug-in base, installation of the circuit breaker on a chassis facilitates handling. Withdrawable chassis circuit breakers offer three positions, with transfer from one to the other after mechanical unlocking:

- Connected: the power circuits are connected.
- Disconnected: the power circuits are disconnected, the circuit breaker can be operated to check auxiliary operation.
- Removed: the circuit breaker is free and can be removed from the chassis.

The following types of circuit breaker can be installed in a chassis:

- 3P and 4P circuit breakers for general-purpose applications
- Circuit breakers with toggle handle, direct rotary handle, or extended rotary handle
- Motor-operated circuit breakers

The withdrawable circuit breaker is made up of:

- The fixed circuit breaker
- A plug-in kit
- Two chassis side plates for the plug-in base
- Two chassis side plates for the circuit breaker

For more information about withdrawable circuit breaker installation, consult the instruction sheets on the Schneider Electric website:

- GHD16277AA, Chassis side plates for ComPacT NSX100-250
- GHD16317AA, Chassis side plates for ComPacT NSX400-630

Plug-in Kit and Chassis Installation Demonstration Video

For information about installation of ComPacT NSX DC circuit breakers, consult the ComPacT NSX100–250 circuit breakers installation video. To access the video, click the following link: <https://youtu.be/XaXO6QgeWvM>, or copy and paste the link to your Web browser.

Disconnecting the Circuit Breaker

⚡ ⚠ DANGER

HAZARD OF ELECTRIC SHOCK, EXPLOSION, OR ARC FLASH

- Apply appropriate personal protective equipment (PPE) and follow safe electrical work practices. See NFPA 70E, CSA Z462, NOM-029-STPS, or local equivalent.
- This equipment must only be installed and serviced by qualified electrical personnel.
- The circuit breaker must be in the **O (OFF)** position.
- Do not use tools to disconnect or connect the circuit breaker.

Failure to follow these instructions will result in death or serious injury.

Follow this procedure to disconnect the circuit breaker:

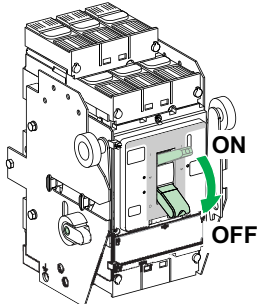
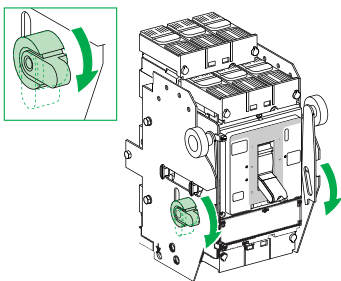
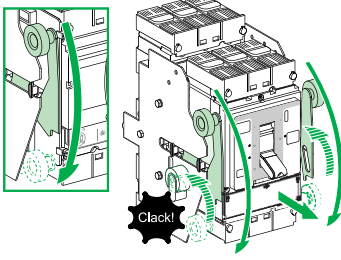
Step	Action
1	 <p>Switch the circuit breaker to the O (OFF) position.</p>
2	 <p>Move both locking levers down as far as they can go.</p>
3	 <p>Push down both operating handles at the same time until you hear a double-click from the locking levers (as the locking levers return to their original position).</p> <p>The circuit breaker is disconnected.</p>

NOTE:

- The auxiliary circuits can be:
 - Automatically disconnected because of the connectors located on the chassis and at the rear of the circuit breaker.
 - Left connected for a circuit breaker with a manual auxiliary connector.
- Open the circuit breaker before disconnecting it. If the circuit breaker is in the closed **I (ON)** position when disconnecting, a safety mechanism ensures that the poles open automatically by tripping the circuit breaker before the pins disconnect.

Removing the Circuit Breaker

⚡ ⚠ **DANGER**

HAZARD OF ELECTRIC SHOCK, EXPLOSION, OR ARC FLASH

- Apply appropriate personal protective equipment (PPE) and follow safe electrical work practices. See NFPA 70E, CSA Z462, NOM-029-STPS, or local equivalent.
- This equipment must only be installed and serviced by qualified electrical personnel.
- The circuit breaker must be in the **O (OFF)** position.
- Do not use tools to disconnect or connect the circuit breaker.

Failure to follow these instructions will result in death or serious injury.

Follow this procedure to remove the circuit breaker:

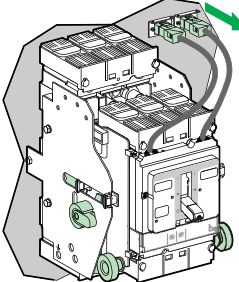
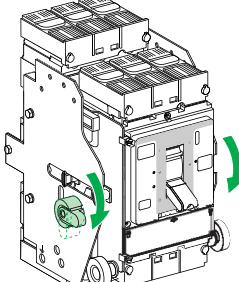
Step	Action	
1		Disconnect the circuit breaker. Disconnect the manual auxiliary connector (if the circuit breaker has one).
2		Move both locking levers down.

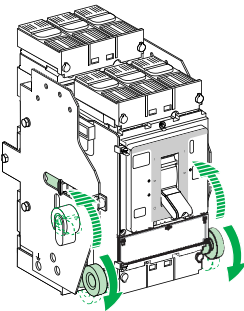
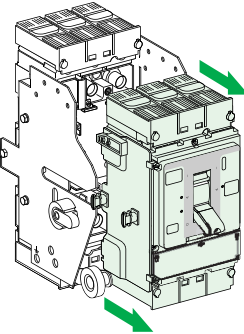
Step	Action	
3		Push down both operating handles as far as the next notch.
4		Remove the circuit breaker, keeping it horizontal.

Connecting the Circuit Breaker

⚠️⚠️ DANGER

HAZARD OF ELECTRIC SHOCK, EXPLOSION, OR ARC FLASH

- Apply appropriate personal protective equipment (PPE) and follow safe electrical work practices. See NFPA 70E, CSA Z462, NOM-029-STPS, or local equivalent.
- This equipment must only be installed and serviced by qualified electrical personnel.
- The circuit breaker must be in the **O (OFF)** position.
- Do not use tools to disconnect or connect the circuit breaker.

Failure to follow these instructions will result in death or serious injury.

Follow this procedure to connect the circuit breaker:

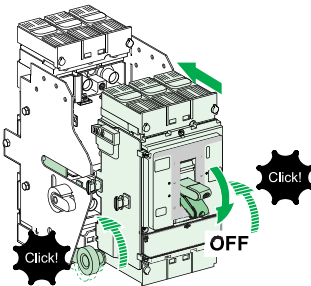
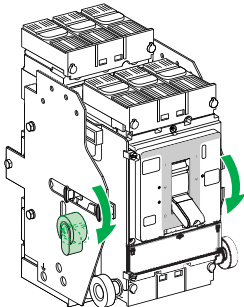
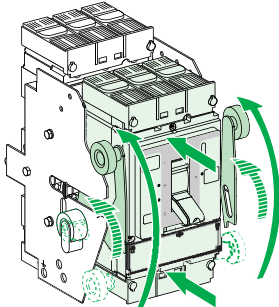
Step	Action	
1		<p>Switch the circuit breaker to the open O (OFF) position.</p> <p>Move both operating handles down to the low position on the chassis.</p> <p>Push in the circuit breaker until the locking levers clicks.</p>
2		<p>Move both locking levers forward.</p>
3		<p>Raise both locking levers at the same time.</p>

NOTE: Open the circuit breaker before connecting it. If the circuit breaker is in the closed **I (ON)** position when connecting, a safety mechanism ensures that the poles open automatically by tripping the circuit breaker before the pins connect.

Withdrawable Circuit Breaker Protection Against Direct Contact With Power Circuits

The following table shows withdrawable circuit breaker configurations with the corresponding protection indices (IP):

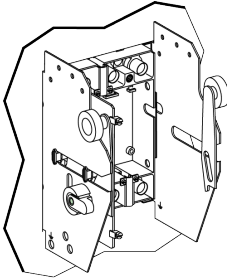
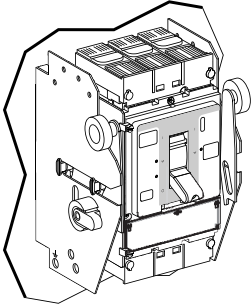
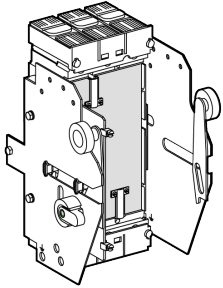
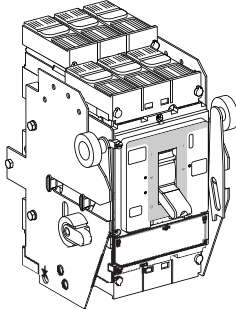
Configuration	Protection index	Description
	IP20	Built-in chassis: <ul style="list-style-type: none"> Without circuit breaker With circuit breaker without terminal shields
	IP40	Built-in chassis and circuit breaker with terminal shields.
	IP40	Chassis with adapter, terminal shields and blanking plate without circuit breaker: <ul style="list-style-type: none"> The adapter enables the use of all the connection accessories of the withdrawable circuit breaker. It is required to equip the withdrawable circuit breaker with long and short terminal shields and interphase barriers. Terminal shields are mandatory for withdrawable circuit breakers. Short terminal shields are supplied in the plug-in kit. They can be replaced by long terminal shields available as an option. The blanking plate is not supplied by Schneider Electric.
	IP40	Chassis with adapter and terminal shields, and circuit breaker with terminal shields.

Auxiliary Circuit Test with Circuit Breaker Disconnected (Optional)

The auxiliary circuit test function is possible with circuit breakers which have manual auxiliary connectors.

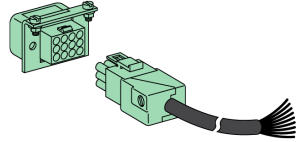

In the disconnected position, operate the circuit breaker (by the actuator or push-to-trip button) to check whether the auxiliary circuits are working correctly.

Disconnect the manual auxiliary connector (if the circuit breaker has one) before removing the circuit breaker.

Carriage Switches (Optional)

Two changeover contacts can be installed on the chassis:

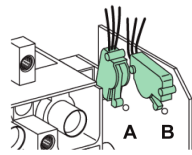

A Connected-position carriage switch (CE)

B Disconnected-position carriage switch (CD)

For more details about contact operation, refer to *control auxiliaries*, page 90.

Carriage switches, in conjunction with the IO module, provide the chassis management function, which is used to:

- Record and check the position of the moving part of the withdrawable circuit breaker in the chassis
- Provide information about preventive maintenance actions
- Notify the remote controller about the position of the withdrawable circuit breaker.

For more information about the chassis management function, refer to DOCA0055** *Enerlin'X IO – Input/Output Application Module for One IEC Circuit Breaker – User Guide*, page 7.

Locking the Chassis

The chassis handle can be locked with up to 3 padlocks (not supplied) or keylock.

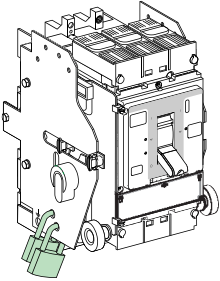
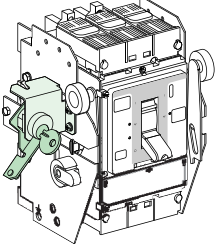
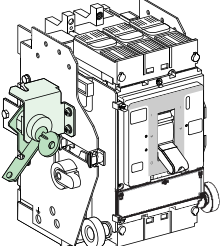
Illustration	Description
	<p>Lock the circuit breaker using up to 3 padlocks (not supplied) with a shackle diameter of 5–8 mm (0.2–0.3 in.) to prevent connection.</p>
	<p>Lock the circuit breaker using a keylock in the connected position.</p>
	<p>Lock the circuit breaker using a keylock in the disconnected position.</p>

For more information about the accessory offer, refer to LVPED221002EN
ComPacT NSX, ComPacT INS/INV, MasterPacT NW DC - DC PV Catalog, page 7.

Accessories

Accessories for Safety

A comprehensive accessory offer is available for ComPacT NSX DC circuit breakers. Accessories can be installed on site to improve safety and ease of operation.

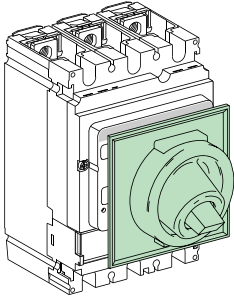
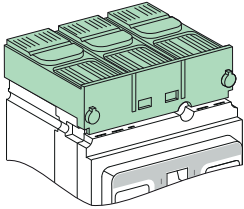
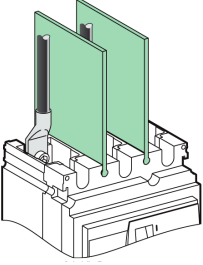
		
<p>Sealed boot for the toggle handle, providing IP43 protection on the front</p>	<p>Short or long terminal shields, providing IP40 protection</p>	<p>Flexible interphase barriers improving isolation between power connections</p>

For more details on the range of accessories, refer to LVPED221002EN *ComPacT NSX, ComPacT INS/INV, MasterPacT NW DC - DC PV Catalog*, page 7.

Accessories for Safety According to Circuit Breakers

- For switch-disconnectors ≥ 500 Vdc, compulsory accessories for safety are:
 - terminal shields
 - interphase barriers
- For circuit breakers ≥ 500 Vdc, compulsory accessories for safety are terminal shields
- For circuit breakers or switch-disconnectors < 500 Vdc, optional accessories for safety are:
 - terminal shields
 - interphase barriers

Terminal Shields with Precut Grids

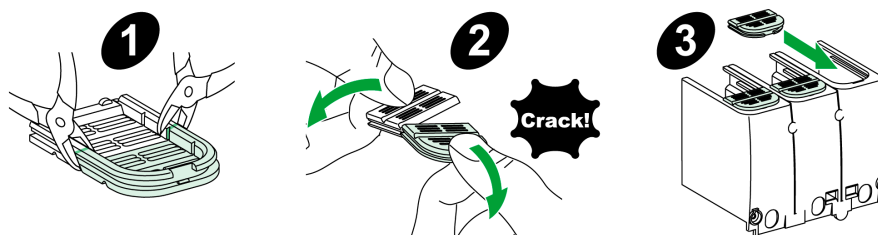

1 Cutting a grid

2 Adjusting the size of the grid

3 Inserting the grid in the terminal shield

Terminal shields with precut grids simplify the onsite connection of circuit breakers regardless of the number of conductors to be connected. The procedure for installing precut grids is described in the instruction sheets, page 7.

Short Terminal Shields

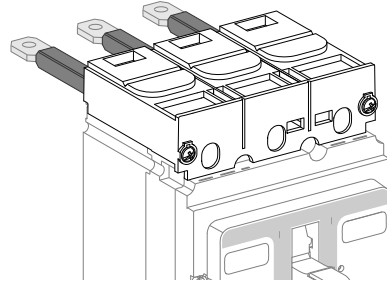

The procedure for installing short terminal shields is described in the instruction sheets, page 7.

ComPacT NSX DC Electric Auxiliary Devices

What's in This Part

Electric Auxiliary Devices Summary	77
Standard Indication and Control Auxiliaries	82
Remote Indication and Communication Auxiliaries	92

Electric Auxiliary Devices Summary

Electric Auxiliary Devices for General-Purpose Applications

The following table shows the electric auxiliary devices that can be added to the ComPacT NSX DC circuit breakers for general-purpose applications. For more information, refer to LVPED221002EN *ComPacT NSX, ComPacT INS/INV, MasterPacT NW DC - DC PV Catalog*, page 7.

Electric Auxiliary Device	NSX100 DC			NSX160 DC			NSX250 DC	NSX400 DC	NSX630 DC	NSX1200 DC
	1P	2P	3P/4P	1P	2P	3P/4P	3P/4P	3P/4P	3P/4P	2P
OF or SD indication auxiliary (wired or wireless)	-	✓	✓	-	✓	✓	✓	✓	✓	✓
SDE auxiliary contact	-	-	✓	-	-	✓	✓	✓	✓	✓
MN undervoltage trip release	-	✓	✓	-	✓	✓	✓	✓	✓	✓
MX shunt trip release	-	✓	✓	-	✓	✓	✓	✓	✓	✓
BSCM Modbus SL/ULP module	-	-	✓	-	-	✓	✓	✓	✓	✓
SD auxiliary contact for BSCM Modbus SL/ULP module	-	-	✓	-	-	✓	✓	✓	✓	✓
NSX cord	-	-	✓	-	-	✓	✓	✓	✓	✓

Electric Auxiliary Devices for Photovoltaic and Marine Applications

The following table shows the electric auxiliary devices that can be added to the ComPacT NSX DC circuit breakers for photovoltaic and marine applications. For more information, refer to LVPED221002EN *ComPacT NSX, ComPacT INS/INV, MasterPacT NW DC - DC PV Catalog*, page 7.

Electric Auxiliary Device	NSX80-200 DC PV	NSX400-500 DC PV	NSX100-250 DC EP	NSX250-500 DC EP
	4P	4P	4P	4P
OF or SD indication auxiliary (wired or wireless)	✓	✓	✓	✓
SDE auxiliary contact	✓	✓	✓	✓
MN undervoltage trip release	✓	✓	✓	✓
MX shunt trip release	✓	✓	✓	✓
BSCM Modbus SL/ULP module	✓	✓	-	-
SD auxiliary contact for BSCM Modbus SL/ULP module	✓	✓	-	-
NSX cord	✓	✓	-	-

Safety Instructions for Photovoltaic Applications

Special care is required when adding electric auxiliary devices into circuit breakers for photovoltaic applications.

⚡ ⚠ DANGER

HAZARD OF ELECTRIC SHOCK, EXPLOSION OR ARC FLASH

- Isolate the circuit breaker upstream and downstream before removing the front cover.
- Always use a properly rated voltage sensing device to confirm that power is off.
- Replace the front cover before turning on power to this equipment.

Failure to follow these instructions will result in death or serious injury.

Electrical Auxiliaries Installation Demonstration Video

For information about installation of ComPacT NSX DC circuit breakers, consult the ComPacT NSX100–250 circuit breakers installation video. To access the video, click the following link: <https://youtu.be/zDqRyZHBWr4>, or copy and paste the link to your Web browser.

Slots for Electric Auxiliary Devices on ComPacT NSX100/160 DC 2P Circuit Breakers

The following table shows the possible slots for electric auxiliary devices mounted in the case. Only one auxiliary can be installed per slot. For more information, refer to LVPED221002EN *ComPacT NSX, ComPacT INS/INV, MasterPacT NW DC - DC PV Catalog*, page 7.

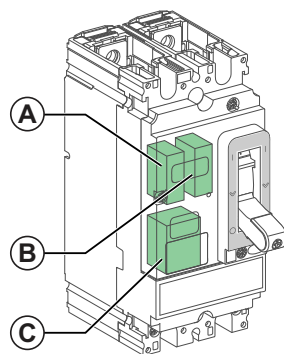

Electric Auxiliary Device	Slot		
	A	B	C
OF1 (wired or wireless)	✓	–	–
SD (wired or wireless)	–	✓	–
MN	–	–	✓
MX	–	–	✓

Slots for Electric Auxiliary Devices on ComPacT NSX100-250 DC 3P/4P Circuit Breakers

The following table shows the possible slots for the electric auxiliary devices mounted in the case. Only one auxiliary can be installed per slot. For more information, refer to LVPED221002EN *ComPacT NSX, ComPacT INS/INV, MasterPacT NW DC - DC PV Catalog*, page 7.

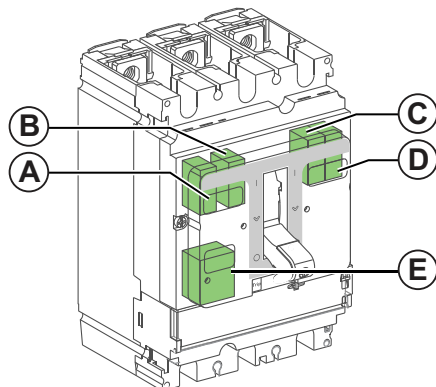

Electric Auxiliary Device	Slot					Comments
	A	B	C	D	E	
Standard indication and control auxiliaries						
OF1 (wired or wireless)	✓	–	–	–	–	For all trip unit types and control types (toggle handle, rotary handle, or motor mechanism).
OF2 (wired or wireless)	–	–	–	✓	–	
SD (wired or wireless)	–	✓	–	–	–	
SDE (wired or wireless)	–	–	✓	–	–	
MN	–	–	–	–	✓	
MX	–	–	–	–	✓	
Remote indication and communication auxiliaries						
BSCM Modbus SL/ULP module	–	–	✓	✓	–	–
SD auxiliary contact for BSCM Modbus SL/ULP module	–	✓	–	–	–	Compatible with the BSCM Modbus SL/ULP module in Modbus SL only mode.
NSX cord	–	✓	–	–	–	For connection of the BSCM Modbus SL/ULP module to ULP modules.

Slots for Electric Auxiliary Devices on ComPacT NSX400–630–1200 DC 3P/4P Circuit Breakers

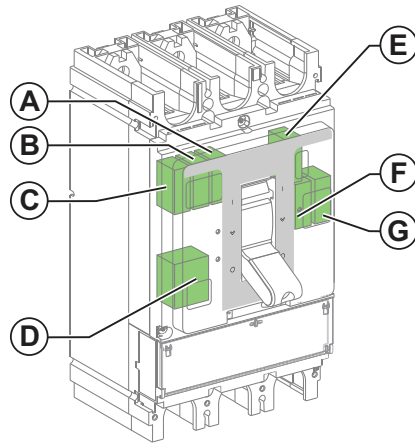

The following table shows the possible slots for the electric auxiliary devices mounted in the case. For more information, refer to LVPED221002EN *ComPacT NSX, ComPacT INS/INV, MasterPacT NW DC - DC PV Catalog*, page 7.



Electric Auxiliary Device	Slot							Comments
	A	B	C	D	E	F	G	
Standard indication and control auxiliaries								
OF1 (wired or wireless)	-	-	✓	-	-	-	-	
OF2 (wired or wireless)	-	✓	-	-	-	-	-	For all trip unit types and control types (toggle handle, rotary handle, or motor mechanism).
OF3 (wired or wireless)	✓	-	-	-	-	-	-	
OF4 (wired or wireless)	-	-	-	-	-	-	✓	
SD (wired or wireless)	-	-	-	-	✓	-	-	
SDE (wired or wireless)	-	-	-	-	-	✓	-	
MN	-	-	-	✓	-	-	-	
MX	-	-	-	✓	-	-	-	
Remote indication and communication auxiliaries								
BSCM Modbus SL/ULP module	-	-	-	-	-	-	✓	-
SD auxiliary contact for BSCM Modbus SL/ULP module	-	-	-	-	-	-	-	Compatible with the BSCM Modbus SL/ULP module in Modbus SL only mode.
NSX cord	-	-	-	-	-	-	✓	For connection of the BSCM Modbus SL/ULP module to ULP modules.

Operation of the Indication Contacts

The following table shows the position of the indication contacts (or outputs) relative to the position of the actuator and main contacts.

	Position of the actuator and the main contacts				
	 ON	 Tripped			 OFF
		Tripped by:			
		MN/MX	Push-to-Trip	Trip Unit	
Name	Position of Indication Contacts				
OF	✓	–	–	–	–
SD	–	✓	✓	✓	–
SDE	–	–	–	✓	–
✓ : Contact closed – : Contact open					

NOTE: The indication (changeover) contacts are represented in the switchboard by the state of the Normally Open (NO) contact.

The state of the NO contact is open:

- for OF indication contacts when the circuit breaker is in the **O (OFF)** position.
- for SD and SDE indication contacts when the associated function is not active.

Sequence chart of the OF indication contacts relative to the main contacts

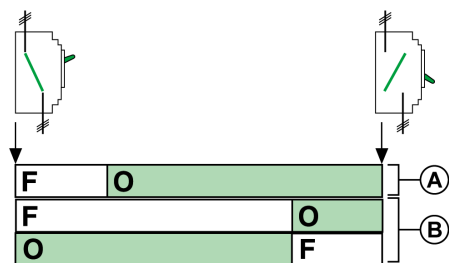

A Main contacts

B Position of OF changeover contacts

Operation of the Wireless Indication Auxiliaries

The wireless indication auxiliary provides the same information as a standard wired indication contact in OF, SD, or SDE positions. The information is sent remotely to a gateway or panel server.

During commissioning of the wireless indication auxiliary, the user defines the type of information sent: Open/Close or Trip.

Standard Indication and Control Auxiliaries

What's in This Chapter

Indication Contacts	83
Wireless Indication Auxiliary	85
Control Auxiliaries	90

Indication Contacts

Introduction

One indicator contact model provides OF, SD, and SDE indication functions. The position of the contact inside the case determines the function.

Indication contacts are either under the front face of the circuit breaker, under the motor mechanism, or in the rotary handle. Installation is in a compartment isolated from the power circuits. There are two types:

- Standard contact with spring terminals

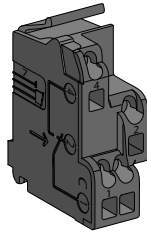

- Low-level contact with screw terminals

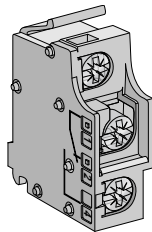

For more information about installation, consult the instruction sheet on the Schneider Electric website: [NNZ4314501 Indication Contacts](#)

Standard and Low-Level Contacts

Standard and low-level contacts are the common point changeover type.

NC NO

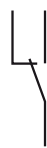

NC Normally Closed contact

NO Normally Open contact

The following table describes the operation of standard and low-level volt-free contacts:

Name	Definition
OF indication contact	Changeover: The NO contact is normally open when the circuit breaker is in the O (OFF) position.
SD indication contact	Trip indication: The SD contact indicates that the circuit breaker has tripped due to: <ul style="list-style-type: none"> • Electrical fault detected by the trip unit • Operation of the MX or MN voltage releases • Operation of the push-to-trip button • Connecting/Disconnecting the withdrawable circuit breaker • Manually opening the motor mechanism
SDE indication contact	Electrical fault indication: The SDE contact indicates that the circuit breaker has tripped on an electrical fault due to an electrical fault detected by the trip unit.

Wireless Indication Auxiliary

Introduction

The wireless indication auxiliary provides remote and local information about the circuit breaker status.

The position of the wireless indication auxiliary inside the case, and the setting of the gateway or Panel Server, determine its function. The wireless indication auxiliary provides the following information remotely:

Position of wireless indication auxiliary	Information provided
OF slot	Open/close circuit breaker status
SD slot	Trip indication
SDE slot	Electrical fault indication

When in the SD slot, the wireless indication auxiliary can be configured to indicate a circuit breaker trip locally. The status LED blinks orange for eight hours.

The wireless indication auxiliary must be paired with a gateway or Panel Server.

The wireless indication auxiliary is powered by an internal battery. It sends a notification to indicate that the battery needs to be replaced.

For more information about installation, consult the instruction sheet on the Schneider Electric website: [NNZ8882801 Wireless Indication Auxiliary](#)

Description

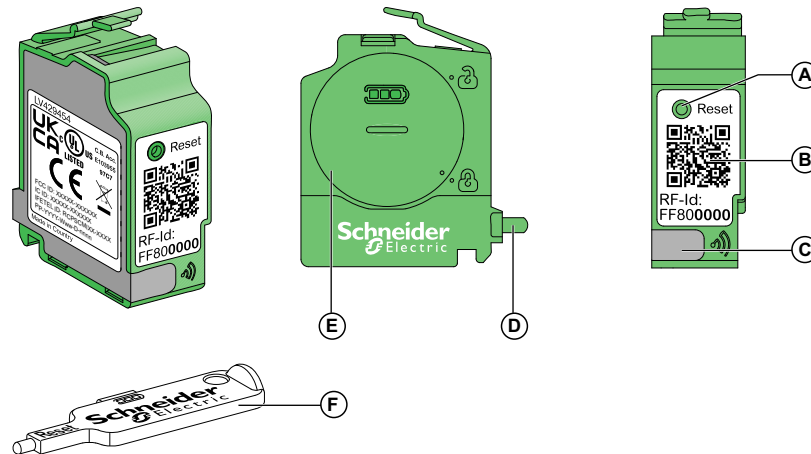

A Reset button

B QR code to access device information, including RF-Id address

C Status LED

D Actuator

E Battery cover

F Reset tool

Reset Button

The Reset button allows you to :







- Access setting mode to set the status LED indication mode

- Pair or unpair the wireless indication auxiliary
- Perform a reset to factory settings (press the Reset button for more than 10 seconds)

Status LED

A status LED on the wireless indication auxiliary provides the following information:

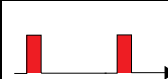

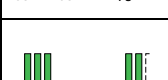
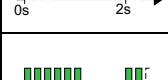
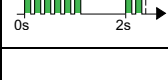
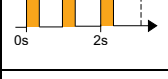





- Help with commissioning and maintenance steps
- Status of communication between wireless indication auxiliary and gateway or Panel Server
- Status of the wireless indication auxiliary
- Indication of circuit breaker trip (available when LED indication mode is ON).

Status LED	Description	Action
	Wireless indication auxiliary switched off or not in communication with gateway or Panel Server.	None
	Wireless indication auxiliary in pairing mode, searching for a gateway or Panel Server.	Wait until the gateway or Panel Server is identified.
	Wireless indication auxiliary in identification mode.	Wait until wireless indication auxiliary is discovered in network.
	Wireless indication auxiliary in communication. One green flash at each frame sent.	None
	Occasional loss of communication with the gateway or Panel Server. One red flash at each frame lost.	Check communication setting with the gateway or Panel Server.
	No communication with the gateway or Panel Server.	Check communication setting with the gateway or Panel Server.
	Wireless indication auxiliary in setting mode, with LED indication mode set to OFF.	Set LED indication mode to ON by pressing the Reset button.
	Wireless indication auxiliary in setting mode, with LED indication mode set to ON.	Set LED indication mode to OFF by pressing the Reset button.
	Trip indication when wireless indication auxiliary is in SD slot and configured in LED indication mode ON.	Check tripping cause.
	Battery out of power. Three red flashes each time the wireless indication auxiliary wakes up.	Change the battery.

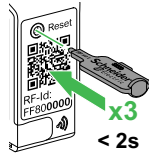
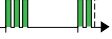
Setting LED Indication Mode

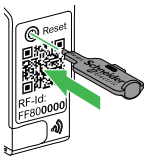
Set the LED indication mode of the wireless indication auxiliary to ON to indicate a trip locally when the wireless indication auxiliary is installed in the SD slot. The LED indication mode is factory-set to OFF.

Follow this procedure to change the LED indication mode.

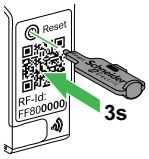
Step	Action		Status LED
1	Use the reset tool to press the Reset button. Result: The wireless indication auxiliary status LED blinks.		
2	Press the Reset button three times in less than two seconds. The wireless indication auxiliary is in setting mode. The Status LED flashes: <ul style="list-style-type: none"> • Three times every two seconds if LED indication mode is OFF • Six times every two seconds if LED indication mode is ON 		OFF 
			ON 
3	Press the Reset button once to change the LED indication mode. The flashing pattern changes according to the new LED indication mode.		OFF   ON 
4	To exit setting mode, press the Reset button for three seconds. NOTE: If the Reset button is not pressed, the wireless indication auxiliary exits setting mode after two minutes.		—

Commissioning

Commission the wireless indication auxiliary by using EcoStruxure Power Commission software or the webpages of the gateway or Panel Server.

NOTE: The wireless indication auxiliary can be commissioned with the device switched off.

Before proceeding with pairing, ensure that the gateway or Panel Server has the latest available firmware version. Refer to the user guide of the relevant gateway.

Step	Action
1	<p>Put the wireless indication auxiliary in pairing mode in one of the following ways:</p> <ul style="list-style-type: none"> • If the wireless indication auxiliary is not installed in the circuit breaker, press the Reset button or the actuator. • If the wireless indication auxiliary is installed in the device without front cover, press the Reset button. • If the wireless indication auxiliary is installed in the OF slot, change the state of the device by opening or closing the device. • If the wireless indication auxiliary is installed in the SD slot, press the push-to-trip button. <p>NOTE: the device must be closed before pressing the push-to-trip button.</p> <ul style="list-style-type: none"> • If the wireless indication auxiliary is installed in the SDE slot, remove the front cover and press the Reset button. <p>NOTE: The device must be closed before simulating an SDE fault.</p> <p>Result: The status LED blinks orange. The wireless indication auxiliary stays in pairing mode for three minutes.</p>
2	<p>Pair the gateway or Panel Server with the wireless indication auxiliary by using EcoStruxure Power Commission software or the webpages of the gateway or Panel Server.</p> <p>Result: The status LED blinks green to indicate that the wireless indication auxiliary is paired.</p>
3	<p>Configure the wireless indication auxiliary by using EcoStruxure Power Commission software or the webpages of the gateway or Panel Server.</p>

Changing the Radio Frequency Channel

Follow this procedure to change the radio frequency channel used by the gateway or Panel Server to communicate:

Step	Action
1	<p>Put the wireless indication auxiliary in pairing mode in one of the following ways:</p> <ul style="list-style-type: none"> • If the wireless indication auxiliary is not installed in the circuit breaker, press the Reset button or the actuator. • If the wireless indication auxiliary is installed in the device without front cover, press the Reset button. • If the wireless indication auxiliary is installed in the OF slot, change the state of the device by opening or closing the device. • If the wireless indication auxiliary is installed in the SD slot, press the push-to-trip button. <p>NOTE: the device must be closed before pressing the push-to-trip button.</p> <ul style="list-style-type: none"> • If the wireless indication auxiliary is installed in the SDE slot, remove the front cover and press Reset button. <p>NOTE: The device must be closed before simulating an SDE fault.</p> <p>Result: The wireless indication auxiliary wakes up, and is ready to be configured for three minutes.</p>
2	<p>Change the radio frequency channel used by the gateway or Panel Server to communicate with the wireless indication auxiliary by using EcoStruxure Power Commission software or the webpages of the gateway or Panel Server.</p> <p>Result: The status LED blinks green to indicate that the wireless indication auxiliary is in communication with the gateway or Panel Server.</p>

Replacing the Internal Battery

The wireless indication auxiliary sends a notification six months before the battery needs to be changed.

Use a Murata CR2050W battery to replace the internal battery.

Follow this procedure to replace the internal battery.

Step	Action
1	Remove the wireless indication auxiliary from its slot. Refer to NNZ8882801 <i>Wireless Indication Auxiliary Instruction Sheet</i> .
2	Use the reset tool to remove the battery cover by turning it anti-clockwise.
3	Remove the battery by pressing the top of the battery and recycle it.
4	Reset the wireless indication auxiliary by pressing the Reset button.
5	Insert the new battery, following the guidelines marked in the battery compartment.
6	Put back the battery cover and lock it by turning it clockwise.
7	Reinstall the wireless indication auxiliary in its slot.
8	Put back the front cover of the circuit breaker.

Replacing the Wireless Indication Auxiliary

Follow this procedure to unpair the wireless indication auxiliary and delete it in EcoStruxure Power Commission software or the webpages of the gateway or Panel Server before replacing the wireless indication auxiliary.

Step	Action
1	Remove the wireless indication auxiliary from its slot. Refer to NNZ8882801 <i>Wireless Indication Auxiliary Instruction Sheet</i> .
2	Unpair the wireless indication auxiliary by pressing the Reset button for at least three seconds and releasing, or by using EcoStruxure Power Commission software or the webpages of the gateway or Panel Server.
3	Install the new wireless indication auxiliary in its slot.
4	Pair the wireless indication auxiliary by following the procedure in <i>Commissioning</i> , page 87.
5	Put back the front cover of the circuit breaker.

Control Auxiliaries

Control and Indication Contacts Installed Outside the Circuit Breaker

Control and indication contacts installed outside the case are contacts for specific applications. Refer to LVPED221002EN, page 7 *ComPacT NSX, ComPacT INS/INV, MasterPacT NW DC - DC PV Catalog*.

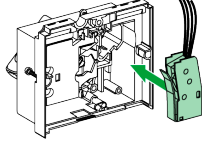
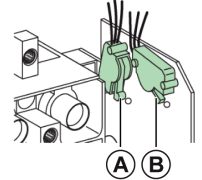
<p>CAM contacts</p> 	<p>Early-operation contacts</p> <p>Install in the rotary handle:</p> <ul style="list-style-type: none"> • Early-make contacts (CAF1, CAF2) actuate before the poles close when a circuit breaker manual command is given. • The early-break changeover contact (CAO1) actuates before the poles open when a circuit breaker manual command is given.
<p>Carriage switches</p> 	<p>Connected (CE)/Disconnected (CD) carriage switches</p> <p>Install on the chassis to indicate the position of the circuit breaker in the chassis:</p> <p>A Connected position carriage switch (CE)</p> <p>B Disconnected position carriage switch (CD)</p>

Operation of connected/disconnected carriage switches

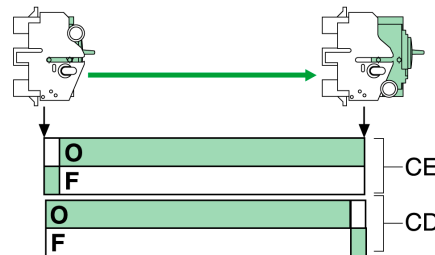

CE Connected position carriage switch

CD Disconnected position carriage switch

Voltage Trip Releases

Use voltage trip releases to trip circuit breakers deliberately using an electrical signal. Install these auxiliaries in the case under the front face.

The characteristics of these auxiliaries comply with the recommendations of standard IEC/EN 60947-2.

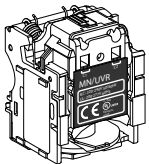
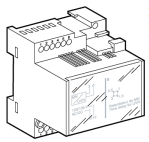
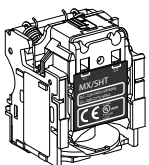
<p>MN</p> 	<p>MN undervoltage trip release</p> <p>This release:</p> <ul style="list-style-type: none"> • Trips the circuit breaker when the voltage is less than 0.35 times the rated voltage U_n. If the voltage is between 0.35 and 0.7 times the rated voltage U_n, tripping is possible but not guaranteed. Above 0.7 times the rated voltage U_n, tripping is impossible. • Closes the circuit breaker again once the voltage reaches 0.85 times the rated voltage. <p>Use this type of trip release for fail-safe emergency stops.</p>
<p>Time-delay unit</p> 	<p>Time-delay unit for MN undervoltage trip release</p> <p>The time-delay unit eliminates nuisance tripping of an undervoltage trip release due to transient voltage dips lasting < 200 ms.</p> <p>There are 2 types of time-delay units: adjustable or fixed.</p>
<p>MX</p> 	<p>MX shunt trip release</p> <p>This release trips the circuit breaker when the voltage exceeds 0.7 times the rated voltage U_n.</p>

Remote Indication and Communication Auxiliaries

What's in This Chapter

BSCM Modbus SL/ULP Module Presentation	93
BSCM Modbus SL/ULP Module Modes	97
BSCM Modbus SL/ULP Module Configuration	102
Communication Test	106
BSCM Modbus SL/ULP Module Firmware Update	107
NSX Cord	108
Insulated NSX Cord	110
SD Auxiliary Contact for BSCM Modbus SL/ULP Module	112
Modbus SL Hub	114

BSCM Modbus SL/ULP Module Presentation

The BSCM Modbus SL/ULP module with commercial reference LV434220 is a Breaker Status Control Module that can be used to communicate data via:

- Modbus Serial Line communication network
- ULP communication network

Use the BSCM Modbus SL/ULP module with ComPacT NSX DC circuit breakers equipped with thermal-magnetic trip units, and with ComPacT NSX DC switch-disconnectors.

NOTE: The BSCM Modbus SL/ULP module cannot be installed in a ComPacT NSX DC EP circuit breaker.

The following data is exchanged:

- OF and SDE circuit breaker states from the BSCM Modbus SL/ULP module
- SD circuit breaker state from SD auxiliary contact for BSCM Modbus SL/ULP module or NSX cord (if present)
- Control instructions for the communicating motor mechanism (if present): opening, closing, and resetting
- Information to assist the operator: storage of the last 10 events

For more information about integrating ComPacT NSX DC circuit breaker communication functions, refer to:

- DOCA0093•• *ULP System (IEC Standard) - User Guide*, page 7
- DOCA0213•• *ComPacT NSX - Modbus Communication Guide*, page 7

Description of the BSCM Modbus SL/ULP Module

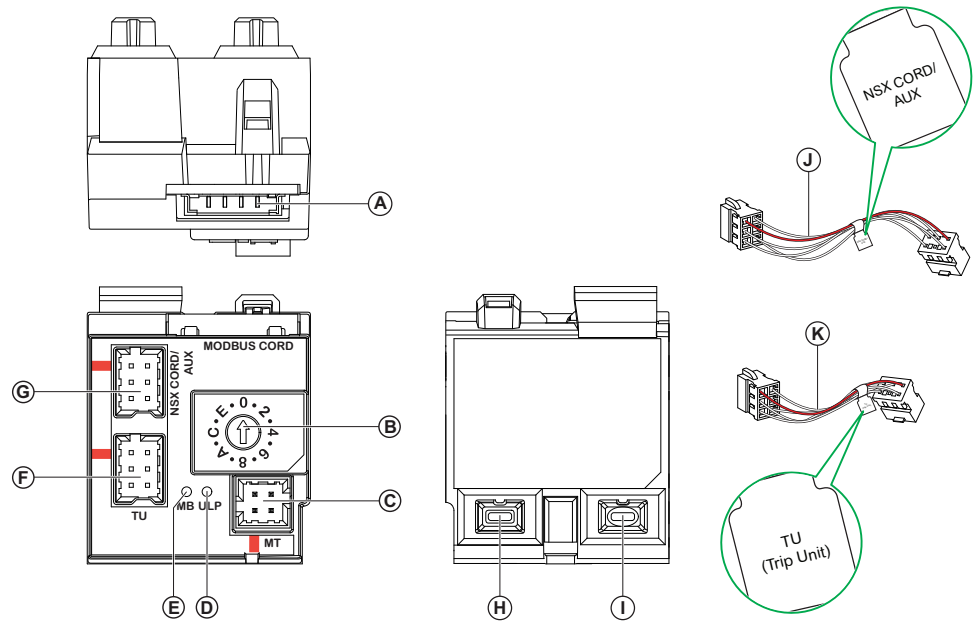







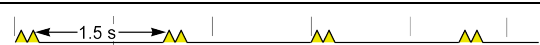

- A. Port for BSCM Modbus SL cord
- B. Modbus address selector rotary switch
- C. Port for communicating motor mechanism
- D. ULP status LED
- E. Modbus status LED
- F. Port for MicroLogic 5, 6, or 7 trip unit (not used)
- G. Port for NSX cord or SD auxiliary contact for BSCM Modbus SL/ULP module
- H. OF contact
- I. SDE contact
- J. Cable to connect the BSCM Modbus SL/ULP module to the NSX cord or SD auxiliary contact for BSCM Modbus SL/ULP module
- K. Cable to connect the BSCM Modbus SL/ULP module to a MicroLogic 5, 6, or 7 trip unit (not used)

ULP LED Indication on BSCM Modbus SL/ULP Module

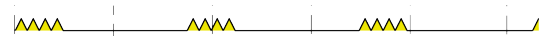
The ULP LED indicates the state of the BSCM Modbus SL/ULP module, even in Modbus SL only mode.

The ULP LED color on the BSCM Modbus SL/ULP module is yellow.

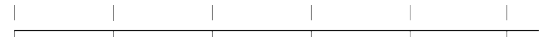
ULP LED	Mode	Action
	Nominal	None
	Conflict	Remove extra ULP module
	Degraded	Replace the BSCM Modbus SL/ULP module at the next maintenance operation
	Test	None
	Non-critical firmware discrepancy	Upgrade firmware at the next maintenance operation
	Non-critical hardware discrepancy	Replace the BSCM Modbus SL/ULP module at the next maintenance operation
	Configuration discrepancy	Install missing features
	Critical firmware discrepancy	Use EcoStruxure Power Commission software to check the firmware and hardware compatibility and follow the recommended actions
	Critical hardware discrepancy	
	Stop	Replace the BSCM Modbus SL/ULP module
	Power off	Check power supply

Modbus Serial Line LED Indication on BSCM Modbus SL/ULP Module

The Modbus Serial Line LED color on the BSCM Modbus SL/ULP module is white.

The LED status is as follows:

- Off: the Modbus Serial Line communication network is disabled.
- On steady: the Modbus Serial Line communication network is enabled.
- Blinking: the Modbus Serial Line communication is ongoing.

Installing the BSCM Modbus SL/ULP Module

The slots used to install the BSCM Modbus SL/ULP module depend on the circuit breaker type.

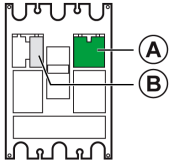
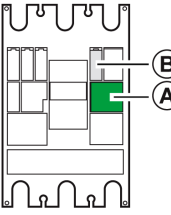
ComPacT NSX100-250 DC 3P/4P	ComPacT NSX400-630 DC 3P/4P ComPacT NSX1200 DC 2P
	
<p>A BSCM Modbus SL/ULP module</p> <p>B NSX cord or SD auxiliary contact for BSCM Modbus SL/ULP module</p>	

The BSCM Modbus SL/ULP module cannot be installed at the same time as an OF contact or the SDE contact.

The BSCM Modbus SL/ULP module can be installed on site.

For more information about installation, consult the instruction sheet on the Schneider Electric website: [PKR1891407 ComPacT NSX DC – BSCM Modbus SL/ULP](https://www.se.com/na/en/literature/PKR1891407/ComPacT_NSX_DC_-_BSCM_Modbus_SL_ULP.pdf).

BSCM Modbus SL/ULP Module Modes

Use of the BSCM Modbus SL/ULP Module Depending on the System Voltage

⚠️⚠️ DANGER

HAZARD OF ELECTRIC SHOCK, EXPLOSION OR ARC FLASH

Do not connect the BSCM Modbus SL/ULP module to Modbus Serial Line communication network when the system voltage is greater than 480 Vac or 480 Vdc.

Failure to follow these instructions will result in death or serious injury.

- When the system voltage is lower than 480 Vac or 480 Vdc, you can use the BSCM Modbus SL/ULP module in the following modes:
 - In Modbus SL only mode
 - In ULP only mode
 - In Modbus SL and ULP mode
- When the system voltage is greater than 480 Vac or 480 Vdc, and less than or equal to 690 Vac or 690 Vdc, use the BSCM Modbus SL/ULP module in ULP only mode, with the insulated NSX cord.

BSCM Modbus SL Only Mode

In Modbus SL only mode, the BSCM Modbus SL/ULP module is used to connect the ComPacT NSX DC circuit breaker to the Modbus Serial Line communication network by using a Modbus SL hub with commercial reference LV434224. To read the SD status on the BSCM Modbus SL/ULP module, use the SD auxiliary contact for BSCM Modbus SL/ULP module with commercial reference LV434210.

The figure below illustrates an example of the BSCM Modbus SL/ULP module in Modbus SL only mode.

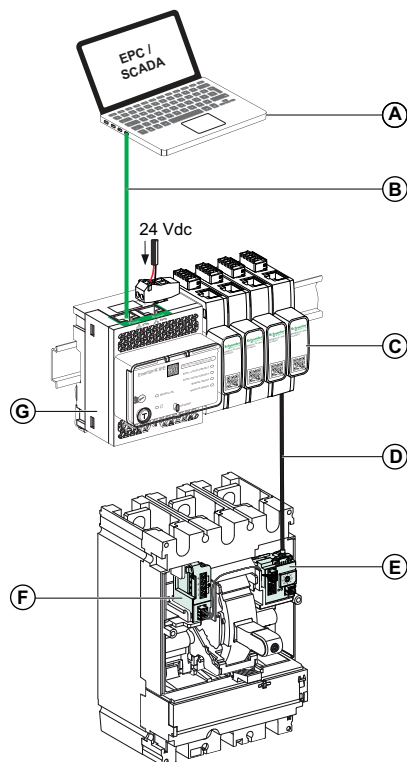

- A. Modbus TCP client
- B. Ethernet cable
- C. Modbus SL hub (LV434224)
- D. Modbus SL cord (LV434221, LV434222, or LV434223)
- E. BSCM Modbus SL/ULP module (LV434220)
- F. SD auxiliary contact for BSCM Modbus SL/ULP module (LV434210)
- G. IFE Ethernet switchboard server (LV434002)

BSCM ULP Only Mode

In ULP only mode, the BSCM Modbus SL/ULP module is used to connect the ComPacT NSX DC circuit breaker to ULP modules such as IFM or IFE communication interface, via ULP communication network using NSX cord. Other ULP modules such as the IO module and the FDM121 display can also be connected to the same ULP communication network.

⚠ ⚠ DANGER**HAZARD OF ELECTRIC SHOCK, EXPLOSION OR ARC FLASH**

- It is forbidden to use the BSCM Modbus SL/ULP module or the insulated NSX cord for system voltages greater than 690 Vac or 690 Vdc.
- If the system voltage is greater than 480 Vac or 480 Vdc, and less than or equal to 690 Vac or 690 Vdc, ULP only mode is the only BSCM Modbus SL/ULP module mode allowed, using insulated NSX cord with commercial reference LV434204.

Failure to follow these instructions will result in death or serious injury.

The ULP only mode is recommended to connect plug-in or withdrawable ComPacT NSX DC circuit breakers to a communication network, by using an IFM or IFE communication interface.

The BSCM Modbus SL/ULP module with commercial reference LV434220 in ULP only mode replaces the BSCM module with commercial reference LV434205. The specific features of BSCM module with commercial reference LV434205 are detailed in the appendices, page 150.

The figure below illustrates an example of the BSCM Modbus SL/ULP module in ULP only mode.

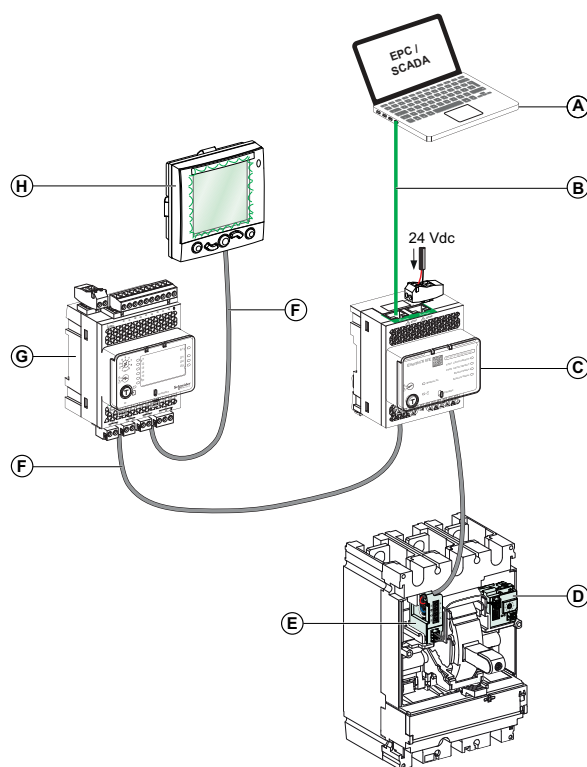

- A. Modbus TCP client
- B. Ethernet cable
- C. IFE Ethernet interface for one circuit breaker (LV434001) or IFE Ethernet switchboard server (LV434002)
- D. BSCM Modbus SL/ULP module (LV434220)
- E. NSX cord (LV434200, LV434201, LV434202, or LV434204)
- F. ULP cord (LV434195, LV434196, LV434197, or LV434198)
- G. IO module (LV434063)
- H. FDM121 display (TRV00121)

BSCM Modbus SL and ULP Mode

In Modbus SL and ULP mode, the BSCM Modbus SL/ULP module is used to connect the ComPacT NSX DC circuit breaker to:

- The Modbus Serial Line communication network via a Modbus SL hub
- ULP modules such as IO module 1, IO module 2, FDM121 display via NSX cord

NOTE: Connection to an IFM or IFE communication interface used as a ULP module is not possible in this mode. If you connect to an IFM or IFE communication interface as a ULP module, the Modbus connection via the Modbus SL hub is not operational any more.

The power to the BSCM Modbus SL/ULP module and to the connected ULP modules is provided by the Modbus SL hub. The Modbus SL hub can be powered directly by the terminal block connector or through the stacking connector.

The figure below illustrates an example of the BSCM Modbus SL/ULP module in Modbus SL and ULP mode.

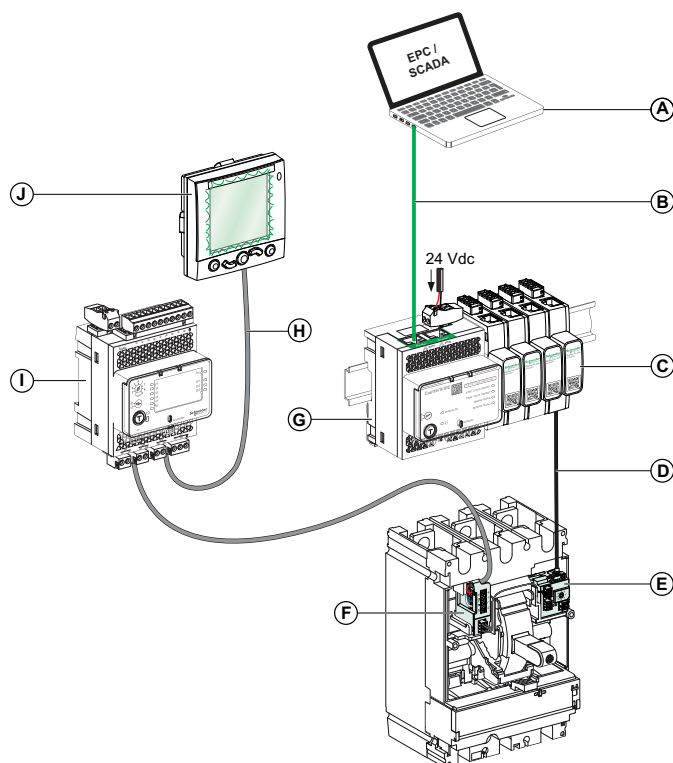

- A. Modbus TCP client
- B. Ethernet cable
- C. Modbus SL hub (LV434224)
- D. Modbus SL cord (LV434221, LV434222, or LV434223)
- E. BSCM Modbus SL/ULP module (LV434220)
- F. NSX cord (LV434200, LV434201, LV434202, or LV434204)
- G. IFE Ethernet switchboard server (LV434002)
- H. ULP cord (LV434195, LV434196, LV434197, or LV434198)
- I. IO module (LV434063)
- J. FDM121 display (TRV00121)

BSCM Modbus SL/ULP Module and Communicating Motor Mechanism

When the ComPacT NSX DC circuit breaker is fitted with a communicating motor mechanism, the BSCM Modbus SL/ULP module is mandatory to enable connection of the motor mechanism to a communication network.

If the BSCM Modbus SL/ULP module is in Modbus SL only mode, the SD auxiliary contact for BSCM Modbus SL/ULP module is mandatory to provide the SD status to the communicating motor mechanism.

BSCM Modbus SL/ULP Module Configuration

The following parameters can be configured in the BSCM Modbus SL/ULP module:

- Modbus address and Modbus parameters (in Modbus SL only mode or Modbus SL and ULP mode)
- Maintenance indicators
- Communicating motor mechanism parameters (if present)

Configuring the BSCM Modbus Address

In Modbus SL only mode and in Modbus SL and ULP mode, configure the BSCM Modbus address by using the Modbus address rotary switch on the front face of the BSCM Modbus SL/ULP module:

- Modbus address rotary switch position 0 allows you to set the BSCM Modbus address from 1 to 99 by using EcoStruxure Power Commission software.
- Modbus address rotary switch positions 1 to D correspond to BSCM Modbus addresses 1 to 13. If the BSCM Modbus address is set from 1 to 13 by using the Modbus address rotary switch, the BSCM Modbus address cannot be set by using EcoStruxure Power Commission software.

NOTE: Modbus address rotary switch positions E and F are not operational and reserved for future use.

For more information about configuration of the BSCM Modbus address, consult PKR1891407 *ComPacT NSX DC – BSCM Modbus SL/ULP Instruction Sheet*.

Configuring the BSCM Modbus Parameters

The Modbus parameters of the BSCM Modbus SL/ULP module can be configured by using the following interfaces:

- the Modbus address rotary switch on the BSCM Modbus SL/ULP module
- EcoStruxure Power Commission (EPC) software

The following table indicates which interface can be used to set each parameter:

Parameters	Value	Factory setting	Set on the BSCM Modbus SL/ULP module	Set on EPC software
Remote padlock	<ul style="list-style-type: none"> • Enabled • Disabled 	Disabled	–	✓
Address	1–99	99	✓ (1)	✓
Baud rate	<ul style="list-style-type: none"> • 4800 • 9600 • 19200 • 38400 	19200	–	✓
Parity	<ul style="list-style-type: none"> • None • Odd • Even 	Even	–	✓
Stop bit	<ul style="list-style-type: none"> • 1 • 2 	1	–	✓
Modbus SL Auto Go Activation	<ul style="list-style-type: none"> • Enabled • Disabled 	Enabled	–	✓

(1) The Modbus address can be set from 1 to 13 only.

NOTE: In ULP only mode, the setting of the BSCM Modbus parameters is not required.

Remote Padlock

The user can enable or disable remote control commands to be sent over the Modbus network to the BSCM Modbus SL/ULP module itself, and to the other modules of the IMU. There is no physical padlock button. Use the remote padlock parameter available in EcoStruxure Power Commission software.

For more information, refer to EcoStruxure Power Commission Online Help.

Modbus SL Auto Go Function

If the Modbus SL Auto Go function is enabled, the BSCM Modbus SL/ULP module automatically detects the communication network speed and parity. The Auto-Speed sensing algorithm tests the available Baud rates and parities and automatically detects the Modbus Serial Line communication network parameters. The Modbus client must send at least 36 frames on the Modbus Serial Line communication network in order to allow the Auto-Speed sensing algorithm to work.

The transmission format is binary with one start bit, eight data bits, and one stop bit in case of even or odd parity, or two stop bits in case of no parity.

If the Auto-Speed sensing algorithm does not detect the network parameters, it is recommended to follow this procedure:

Step	Action
1	Send a Read Multiple Register request (function code 0x03) to the server, using the server ID of the BSCM Modbus SL/ULP module, at any address and for any number of registers.
2	Send this request at least 36 times.

NOTE: If the network speed or parity is changed after the BSCM Modbus SL/ULP module has automatically detected these settings, the BSCM Modbus SL/ULP module must be restarted (power off/power on) in order to detect the new network parameters.

Configuring the Maintenance Indicators

The maintenance indicators of the BSCM Modbus SL/ULP module can be configured by using:

- The EcoStruxure Power Commission software
- The communication network

Configuring the Communicating Motor Mechanism

⚠ CAUTION

HAZARD OF REPEATED CLOSING ON ELECTRICAL FAULT

Reconfiguring of the BSCM Modbus SL/ULP module must be done only by qualified electrical personnel.

Failure to follow these instructions can result in injury or equipment damage.

By default, the communicating motor mechanism can be reset only locally and automatic reset is disabled. To authorize remote reset, the reset mode of the communicating motor mechanism can be configured by using:

- The EcoStruxure Power Commission software
- The communication network

One of the following remote reset modes can be selected:

- **Enable Reset even if SDE** to authorize resetting of the mechanism using the communication network even after an electrical fault trip.
- **Enable Automatic Reset** to authorize automatic resetting after tripping by the MN, MX trip release, or push-to-trip button.
- **Enable Reset even if SDE** and **Enable Automatic Reset** to authorize automatic resetting even after an electrical fault trip.

Configuring the BSCM Modbus SL/ULP Module With EPC Software

To configure the BSCM Modbus SL/ULP module, use a PC running EcoStruxure Power Commission (EPC) software:

- In Modbus SL only mode or in Modbus SL and ULP mode, connect the PC to an RJ45 port of the Modbus SL hub.
- In ULP only mode, connect the PC to the Service Interface or USB maintenance module connected to the RJ45 connector of a ULP module connected to the BSCM Modbus SL/ULP module (for example, IFM Modbus SL communication interface).

Cybersecurity Recommendations

▲ WARNING

POTENTIAL COMPROMISE OF SYSTEM AVAILABILITY, INTEGRITY, AND CONFIDENTIALITY

- Change default PIN codes and passwords at first use to help prevent unauthorized access to device settings, controls, and information.
- Disable unused ports/services and default accounts to help minimize pathways for malicious attackers.
- Place networked devices behind multiple layers of cyber defenses (such as firewalls, network segmentation, and network intrusion detection and protection).
- Use cybersecurity best practices (for example, least privilege, separation of duties) to help prevent unauthorized exposure, loss, modification of data and logs, or interruption of services.

Failure to follow these instructions can result in death, serious injury, or equipment damage.

For more information, refer to DOCA0122•• *MasterPacT, ComPacT, PowerPacT - Cybersecurity Guide*, page 7.

Communication Test

The user can test the communication between all the ULP modules connected to the BSCM Modbus SL/ULP module. There is no physical button. Connect to EcoStruxure Power Commission software and click the **Locate** button to launch the communication test between all the ULP modules connected to the BSCM Modbus SL/ULP module for 15 seconds.

During the test, all the ULP modules keep working normally.

BSCM Modbus SL/ULP Module Firmware Update

Introduction

The primary reason for updating the firmware of a BSCM Modbus SL/ULP module is to obtain the latest BSCM Modbus SL/ULP features. If the latest BSCM Modbus SL/ULP features are not required, it is not mandatory to update the firmware of the BSCM Modbus SL/ULP module and the Enerlin'X devices of the IMU.

The BSCM Modbus SL/ULP module remains operational and is able to communicate during firmware update.

For all firmware updates, use the latest version of *EcoStruxure Power Commission software*, page 19.

For more information about firmware updates, refer to DOCA0329EN *ComPacT NSX BSCM Modbus SL/ULP Module - Firmware Release Notes*, page 7.

Checking the Firmware Version

Check the BSCM Modbus SL/ULP module firmware version with EcoStruxure Power Commission software.

After updating the firmware version of the BSCM Modbus SL/ULP module, use the latest version of EcoStruxure Power Commission software to check the firmware compatibility between the IMU devices. The **Firmware Update** table helps you to diagnose and identify all discrepancy issues between the IMU devices. This table also provides the recommended actions relevant to the detected discrepancies.

Updating Firmware With EcoStruxure Power Commission Software

The prerequisites for updating the firmware with EcoStruxure Power Commission software are the following:

- Download and install the latest version of EcoStruxure Power Commission software on the PC.
- Connect the PC to a power supply and deactivate standby mode to avoid the possibility of interruption during the update.
- In Modbus SL only mode or in Modbus SL and ULP mode, connect the PC to an RJ45 port of the Modbus SL hub.
- In ULP only mode, connect the PC to the Service Interface or USB maintenance module connected to the RJ45 connector of a ULP module connected to the BSCM Modbus SL/ULP module (for example, IFM Modbus SL communication interface).

The Administrator password of the BSCM Modbus SL/ULP module is required to launch the BSCM Modbus SL/ULP firmware update. For more information, refer to EcoStruxure Power Commission Online Help.

NSX Cord

⚡⚠ DANGER

HAZARD OF ELECTRIC SHOCK, EXPLOSION OR ARC FLASH

- It is forbidden to use the NSX cords LV434200, LV434201, or LV434202 if the system voltage is greater than 480 Vac or 480 Vdc.
- It is mandatory to use the insulated NSX cord LV434204, page 110 if the system voltage is greater than 480 Vac or 480 Vdc, and less than or equal to 690 Vac or 690 Vdc.

Failure to follow these instructions will result in death or serious injury.

Introduction

The NSX cord connects a circuit breaker to the communication network.

The NSX cord can be used with a BSCM Modbus SL/ULP module module.

NOTE: The NSX cord cannot be installed in a ComPacT NSX DC EP circuit breaker.

For more information about integrating ComPacT NSX DC circuit breaker communication functions, refer to:

- DOCA0093EN, page 7 *ULP System (IEC Standard) - User Guide*
- DOCA0213EN, page 7 *ComPacT NSX - Modbus Communication Guide*

Description

The NSX cord consists of a junction box, a cable equipped with an RJ45 connector, and a cable equipped with a screw terminal block.

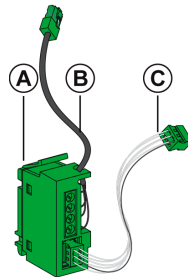

Item	Data medium	Data transmitted	Comments
A	NSX cord microswitch	State of SD contact	The NSX cord goes into the SD slot instead of the auxiliary contact.
B	Cable equipped with an RJ45 connector for connection to a ULP module.	Communication network	Three cable lengths are available: 0.3 m (9.84 ft), 1.3 m (4.27 ft), and 3 m (14.7 ft).
C	Internal link to the BSCM Modbus SL/ULP module	Communication network	–

The NSX cord also provides the 24 Vdc power supply for the BSCM Modbus SL/ULP module (when this module is installed):

Installation

The slots used to install the NSX cord depend on the circuit breaker type.

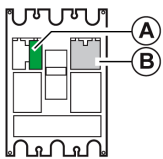
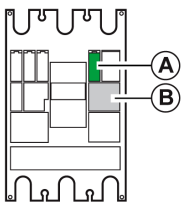
ComPacT NSX100-250 DC 3P/4P	ComPacT NSX400-630 DC 3P/4P ComPacT NSX1200 DC 2P
	
<p>A NSX cord</p> <p>B BSCM Modbus SL/ULP module</p>	

The NSX cord cannot be installed at the same time as the SD auxiliary contact.

The NSX cord can be installed on site.

For more information about installation, consult the instruction sheet on the Schneider Electric website: GHD16047AA *ComPacT NSX100–630 – NSX cord*.

NSX Cord Connection

The NSX cord connects to the following ULP modules:

- IFM or IFE communication interface
- FDM121 display
- IO module

The figure below illustrates the connections from the NSX cord to the IFM Modbus interface.

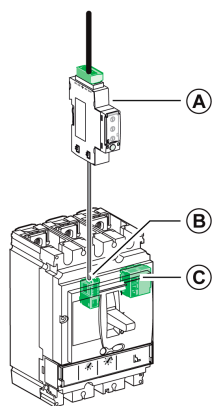

A IFM Modbus interface for one circuit breaker

B NSX cord

C BSCM Modbus SL/ULP module

Insulated NSX Cord

DANGER

HAZARD OF ELECTRIC SHOCK, EXPLOSION OR ARC FLASH

It is mandatory to use the insulated NSX cord LV434204 if the system voltage is greater than 480 Vac or 480 Vdc, and less than or equal to 690 Vac or 690 Vdc.

Failure to follow these instructions will result in death or serious injury.

Introduction

For system voltages greater than 480 Vac or 480 Vdc, and less than or equal to 690 Vac or 690 Vdc, an insulated variant of the NSX cord must be used, terminated by an electronic module with an RJ45 socket connector. A ULP cord must be used to connect the insulated NSX cord electronic module to a ULP module.

The commercial reference for the insulated NSX cord is LV434204.

The insulated NSX cord electronic module must be supplied with 24 Vdc.

For more information about installation, consult the instruction sheet on the Schneider Electric website: [GHD16313AA ComPacT NSX100–630 – Insulated NSX Cord](#).

Electronic Module Characteristics

The following table summarizes the electronic module characteristics:

Characteristic	Value
Dimensions	27 x 27 x 27 mm
Mounting	On DIN rail
Degree of protection of the installed module	<ul style="list-style-type: none"> On the front panel (wall-mounted enclosure): IP40 On the connections (behind the enclosure door): IP20
Operating temperature	-25 to +70 °C
Power supply voltage	24 Vdc -20%/+10% (19.2–26.4 Vdc)
Consumption	<ul style="list-style-type: none"> Typical: 20 mA/24 Vdc at 20 °C Maximum: 30 mA/19.2 Vdc at 60 °C

Insulated NSX Cord Connection

The insulated NSX cord connects to a ULP module:

- IFM or IFE communication interface
- FDM121 display
- IO module

The figure below illustrates an example of connection of ULP modules by using the insulated NSX cord.

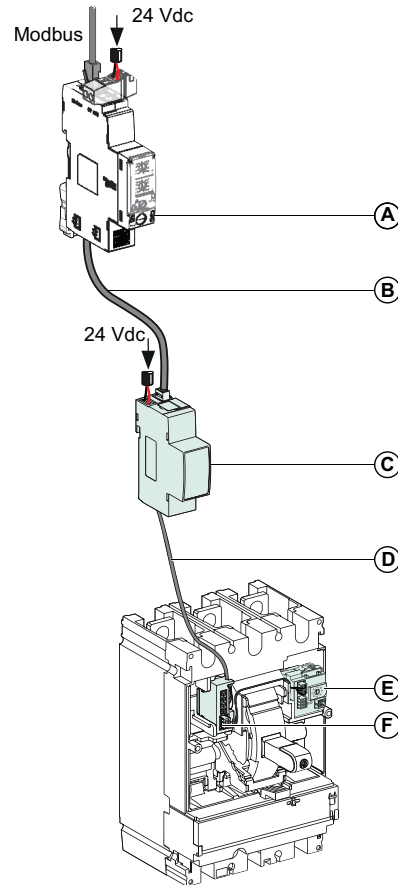

A IFM Modbus SL communication interface for one circuit breaker

B RJ45 plug/plug ULP cable

C Insulated ULP module

D Insulated ULP cord

E BSCM Modbus SL/ULP module

F Connector for ComPacT NSX DC circuit breaker internal connection

SD Auxiliary Contact for BSCM Modbus SL/ULP Module

Introduction

If the BSCM Modbus SL/ULP module is in Modbus SL only mode, the circuit breaker trip (SD) status is provided to the BSCM Modbus SL/ULP module by using the SD auxiliary contact for BSCM Modbus SL/ULP module.

The commercial reference for the SD auxiliary contact for BSCM Modbus SL/ULP module is LV434210.

Description

The SD auxiliary contact for BSCM Modbus SL/ULP module is optional. When it is connected to the BSCM Modbus SL/ULP module in Modbus SL only mode, it indicates that the circuit breaker has tripped due to:

- Operation of the MX or MN voltage releases
- Operation of the push-to-trip button

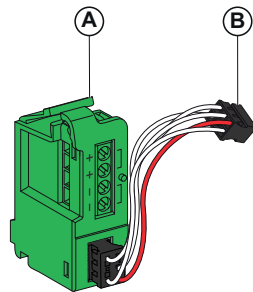

No.	Data medium	Data transmitted	Comments
A	SD auxiliary contact for BSCM Modbus SL/ULP microswitch	State of SD contact	The SD auxiliary contact for BSCM Modbus SL/ULP module goes into the SD slot instead of the auxiliary contact.
B	Internal link to the BSCM Modbus SL/ULP module	Communication network	With the BSCM Modbus SL/ULP module, the SD auxiliary contact for BSCM Modbus SL/ULP module also transmits the circuit breaker states.

Installation

The slots used to install the SD auxiliary contact for BSCM Modbus SL/ULP module depend on the circuit breaker type.

ComPacT NSX100-250 DC 3P/4P	ComPacT NSX400-630 DC 3P/4P ComPacT NSX1200 DC 2P
<p>A SD auxiliary contact for BSCM Modbus SL/ULP module</p> <p>B BSCM Modbus SL/ULP module</p>	

The SD auxiliary contact for BSCM Modbus SL/ULP module cannot be installed at the same time as the SD contact.

The SD auxiliary contact for BSCM Modbus SL/ULP module can be installed on site.

For more information about installation, consult the instruction sheet on the Schneider Electric website: [GHD16256AA 24 Vdc Terminal Block and SD Auxiliary Contact for BSCM Modbus SL/ULP](#).

Modbus SL Hub

Introduction

The Modbus SL hub is used to connect a BSCM Modbus SL/ULP module in Modbus SL only mode and in Modbus SL and ULP mode, to a Modbus client via the Modbus Serial Line communication network.

The commercial reference for the Modbus SL hub is LV434224.

NOTE: If you connect to an IFM or IFE communication interface to the BSCM Modbus SL/ULP module, the Modbus connection via the Modbus SL hub is not operational any more.

Description

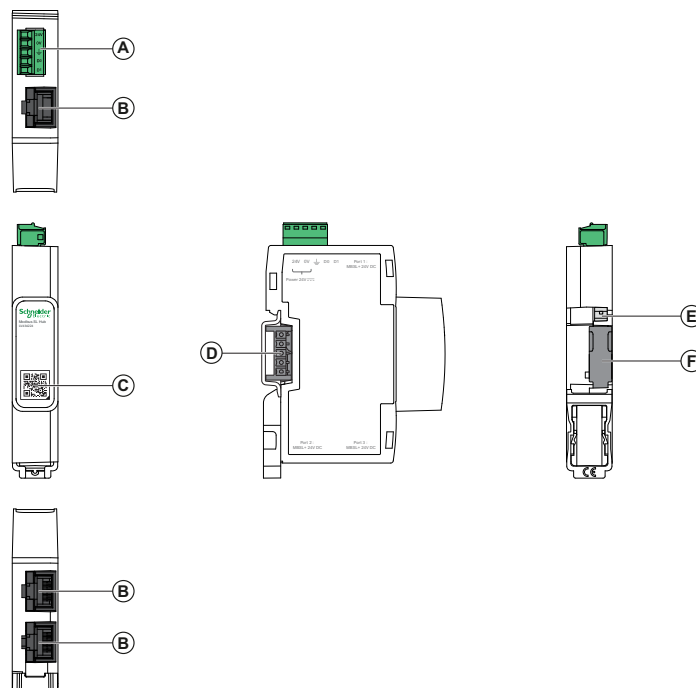

- A. 24 Vdc power supply and Modbus SL terminal block
- B. Three RJ45 Modbus SL ports
- C. QR code to product information
- D. Stacking accessory connection (TRV00217, optional)
- E. Grounding connection
- F. Stacking accessory port cap

Installation

⚡ ⚠ DANGER

HAZARD OF ELECTRIC SHOCK, EXPLOSION OR ARC FLASH

It is forbidden to use the Modbus SL hub when the system voltage is greater than 480 Vac or 480 Vdc.

Failure to follow these instructions will result in death or serious injury.

For information about installation, consult the instruction sheet on the Schneider Electric website: BQT1758404 Modbus SL Hub.

Modbus SL Cords

A Modbus SL cord is used to connect the BSCM Modbus SL/ULP module to the Modbus SL hub. There are three different lengths of Modbus SL cord:

- Commercial reference LV434221: 0.35 m (1.15 ft)
- Commercial reference LV434222: 1.3 m (4.26 ft)
- Commercial reference LV434223: 3 m (9.84 ft)

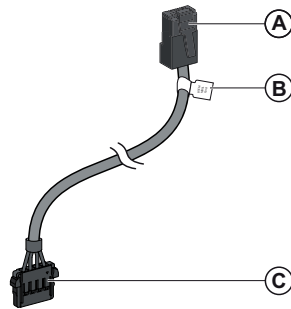

A RJ45 plug to Modbus SL hub

B Label with QR code to product information

C 4-pin connector to BSCM Modbus SL/ULP module

ComPacT NSX DC Trip Units

What's in This Part

Trip Unit Summary	117
TM-D Thermal-Magnetic Trip Unit for 1P and 2P Circuit Breakers	120
TM-D Thermal-Magnetic Trip Unit for 3P and 4P Circuit Breakers up to 63 A	121
TM-DC Thermal-Magnetic Trip Unit for 3P and 4P Circuit Breakers from 80 A to 250 A	123
TM-DC Thermal-Magnetic Trip Unit for 3P and 4P Circuit Breakers from 250 A to 600 A	125
TM-DC Thermal-Magnetic Trip Unit for 2P Circuit Breakers from 630 A to 1200 A	127
TM-G Thermal-Magnetic Trip Unit for 3P and 4P Circuit Breakers up to 250 A	129
TM-DC PV Thermal-Magnetic Trip Unit for 4P Circuit Breakers	131
TM-DC EP Thermal-Magnetic Trip Unit for 4P Circuit Breakers for 1500 Vdc Applications	134
Protection Against Ground Faults for Photovoltaic Applications	137

Trip Unit Summary

General-Purpose Applications

The following table shows the trip units compatible with the ComPacT NSX DC circuit breakers for general-purpose applications. For further details, refer to LVPED221002EN, page 7 *ComPacT NSX, ComPacT INS/INV, MasterPacT NW DC - DC PV Catalog*.

Trip Units	Built-in / Interchangeable	NSX100 DC			NSX160 DC			NSX250 DC	NSX400 DC	NSX630 DC	NSX1200 DC
		1P	2P	3P/4P	1P	2P	3P/4P	3P/4P	3P/4P	3P/4P	2P
NA (switch-disconnector)	Built-in	-	-	-	-	-	-	-	✓	✓	-
NA (switch-disconnector)	Interchangeable	-	-	✓	-	-	✓	✓	-	-	-
TM-D	Built-in	✓	✓	-	✓	✓	-	-	-	-	-
TM-D	Interchangeable	-	-	✓	-	-	✓	-	-	-	-
TM-DC	Built-in	-	-	-	-	-	-	-	✓	✓	✓
TM-DC	Interchangeable	-	-	✓	-	-	✓	✓	-	-	-
TM-G	Interchangeable	-	-	✓	-	-	✓	✓	-	-	-

Photovoltaic and Marine Applications

The following tables shows the trip units compatible with the ComPacT NSX DC circuit breakers for photovoltaic and marine applications. For further details, refer to LVPED221002EN, page 7 *ComPacT NSX, ComPacT INS/INV, MasterPacT NW DC - DC PV Catalog*

ComPacT NSX DC PV 4P Circuit Breakers

Trip Units	Built-in / Interchangeable	NSX80 DC PV	NSX100 DC PV	NSX125 DC PV	NSX160 DC PV	NSX200 DC PV	NSX400 DC PV	NSX500 DC PV
NA (switch-disconnector)	Built-in	-	✓	-	✓	✓	✓	✓
TM-DC PV	Built-in	✓	-	✓	✓	✓	✓	✓

ComPacT NSX DC EP 4P Circuit Breakers

Trip Units	Built-in / Interchangeable	NSX100–250 DC EP					NSX250_630 DC EP				
		NSX100 DC EP	NSX125 DC EP	NSX160 DC EP	NSX200 DC EP	NSX250 DC EP	NSX250 DC EP	NSX320 DC EP	NSX400 DC EP	NSX500 DC EP	NSX630 DC EP
NA (switch-disconnector)	Built-in	✓	-	✓	✓	✓	-	✓	✓	✓	✓
TM-DC EP	Built-in	✓	✓	✓	-	✓	✓	✓	✓	✓	-

Protections and Settings of Thermal-Magnetic Trip Units

The adjustment dials are on the front of the trip units.

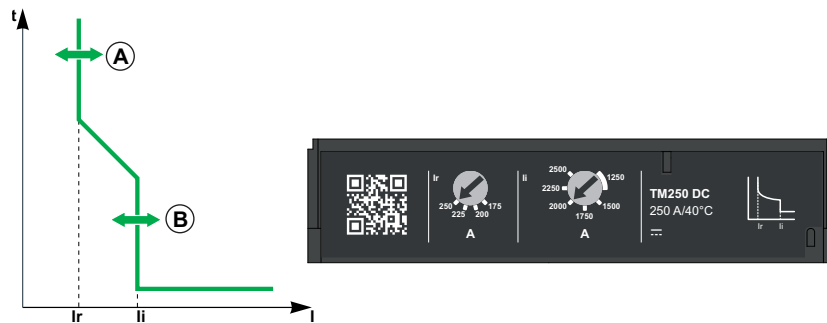

A Overload protection threshold

B Short-circuit protection pick-up

Upgradability of Thermal-Magnetic Trip Units

Interchangeable trip units are upgradable. See tables above for more information on interchangeable trip units.

Onsite swapping of interchangeable trip units is simple and reliable:

- No connections to make
- No special tools (for example, calibrated torque wrench)
- Compatibility of trip units ensured by mechanical cap
- Torque limited screw ensures proper mounting (see drawing below)

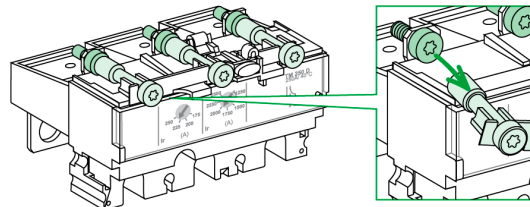

The design of the trip units limits the risk of incorrect tightening or oversights. The simplicity of the swapping process means that it is easy to make the necessary adjustments as operation and maintenance processes evolve.

NOTE: When the trip unit has been mounted by this means, the trip unit can still be removed: the screw head is accessible.

Sealing the Protection

The transparent cover on thermal-magnetic trip units can be sealed to prevent modification of the protection settings.

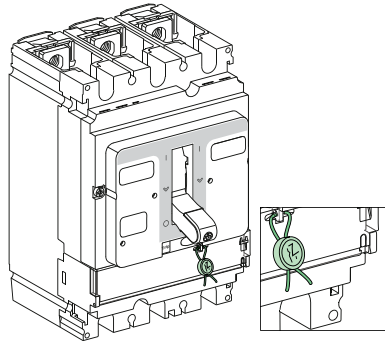

TM-D Thermal-Magnetic Trip Unit for 1P and 2P Circuit Breakers

Introduction

The TM-D thermal-magnetic trip unit for 1P/2P circuit breakers up to 160 A are built-in trip units.

They are designed for AC and DC general-purpose applications.

The TM-D built-in 1P/2P trip units provide:

- fixed thermal threshold
- fixed magnetic pickup

Setting the Thermal Protection

The thermal protection pickup I_r cannot be adjusted and equals the value shown below:

Trip unit rating I_n (A) at 40 °C (104 °F)	16	20	25	32	40	50	63	80	100	125	160
Fixed Pickup I_r (A) at 40 °C (104 °F)	16	20	25	32	40	50	63	80	100	125	160

Setting the Magnetic Protection

The magnetic protection pickup cannot be adjusted and equals the value shown below:

Trip unit rating I_n (A)		16	20	25	32	40	50	63	80	100	125	160
Fixed pickup I_i (A) +/- 20%	DC value	260	260	400	400	700	700	700	800	1,000	1,200	1,250

TM-D Thermal-Magnetic Trip Unit for 3P and 4P Circuit Breakers up to 63 A

Introduction

TM-D thermal-magnetic trip units for 3P/4P circuit breakers up to 63 A are interchangeable trip units.

They are designed for AC and DC general-purpose applications.

The TM-D interchangeable 3P/4P trip units provide:

- adjustable thermal threshold
- fixed magnetic pickup

Description

The setting range and adjustment dials are on the front of the trip unit.

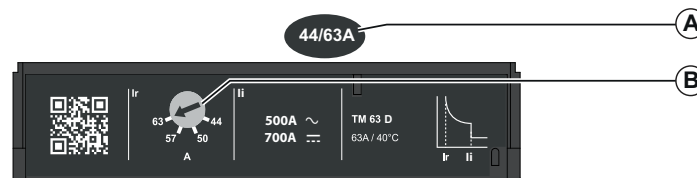

A Setting range for TM-D thermal-magnetic 3P/4P trip unit

B Adjustment dial for the thermal protection pickup I_r

Setting the Thermal Protection

The thermal protection pickup I_r is set by a 4-setting dial.

Turning the thermal protection adjustment dial (**A**) modifies the trip curve as shown (**B**).

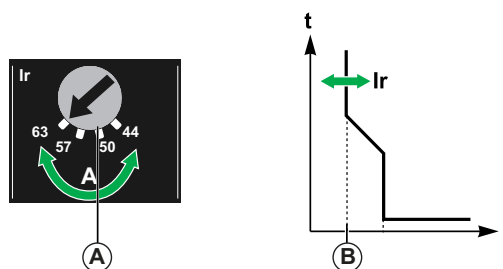

The following table shows the values of the pickup I_r (in amperes) for thermal protection (values indicated on the dial) with respect to every trip unit rating, relative to the position of the dial I_r .

Trip unit rating I_n (A) at 40 °C (104 °F)	16	25	32	40	50	63
Pickup I_r (A) at 40 °C (104 °F)	11	18	22	28	35	44
	13	20	26	32	40	50
	14	23	29	36	45	57
	16	25	32	40	50	63

Setting the Magnetic Protection

The magnetic protection pickup I_i cannot be adjusted and equals the value shown below:

Trip unit rating I_n (A)		16	25	32	40	50	63
Fixed pickup I_i (A) +/- 20%	DC value	260	400	550	700	700	700

TM-DC Thermal-Magnetic Trip Unit for 3P and 4P Circuit Breakers from 80 A to 250 A

Introduction

The TM-DC thermal-magnetic trip unit for 3P/4P circuit breakers from 80 A to 250 A are interchangeable trip units.

They are designed for DC general-purpose applications.

The TM-DC 3P/4P trip units provide:

- adjustable thermal threshold
- fixed magnetic pick-up on trip units with I_n from 80 A to 160 A
- adjustable magnetic pick-up on trip units with I_n 200 A and 250 A

Description

The setting range and adjustment dials are on the front of the trip unit.

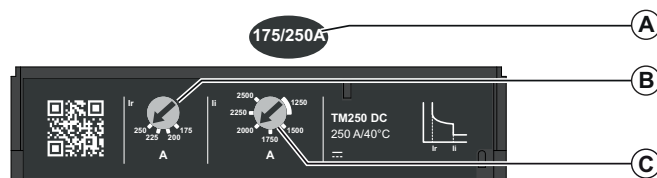

A Setting range for TM-DC thermal-magnetic 3P/4P trip unit

B Adjustment dial for the thermal protection pick-up I_r

C Adjustment dial for the magnetic protection pick-up I_i (for TM-DC 200/250 only)

Setting the Thermal Protection

The thermal protection pick-up I_r is set by a 4-setting dial.

Turning the thermal protection adjustment dial (**A**) modifies the trip curve as shown (**B**).

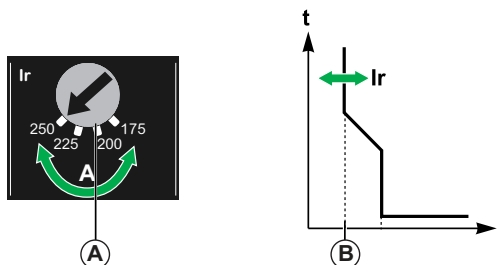

The following table shows the values of the pick-up I_r (in amperes) for thermal protection (values indicated on the dial) with respect to every trip unit rating, relative to the position of the dial I_r .

Trip Unit Rating In (A) at 40 °C (104 °F)					
80	100	125	160	200	250
Pick-up Ir (A) at 40 °C (104 °F)					
56	70	87	112	140	175
64	80	100	128	160	200
72	90	112	144	180	225
80	100	125	160	200	250

Setting the Magnetic Protection on Trip Units With In from 80 A to 160 A

For trip units rated below 200 A, the magnetic protection pick-up cannot be adjusted and equals the value shown below:

	Trip Unit Rating In (A)			
	80	100	125	160
	Fixed Pick-up li (A) +/- 20%			
True DC value	800	800	1,250	1,250

Setting the Magnetic Protection on Trip Units With In 200 A and 250 A

For trip units rated between 200 A and 250 A, the magnetic protection pick-up li is set by a 6-setting dial.

Turning the magnetic protection adjustment dial (A) modifies the trip curve as shown (B).

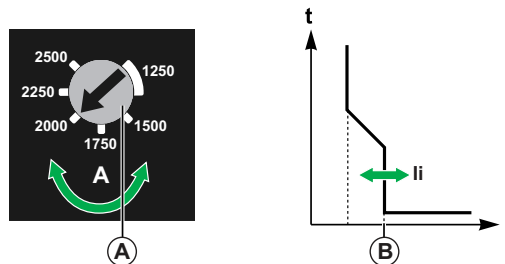

The following table shows the values of the pick-up li (in amperes) for magnetic protection (values indicated on the dial), relative to the position of the li dial:

Trip Unit Rating In (A)	
200	250
Pick-up li (A) +/- 20%	
1,000	1,250
1,200	1,500
1,400	1,750
1,600	2,000
1,800	2,250
2,000	2,500

TM-DC Thermal-Magnetic Trip Unit for 3P and 4P Circuit Breakers from 250 A to 600 A

Introduction

The TM-DC thermal-magnetic trip unit for 3P/4P circuit breakers from 250 A to 600 A are built-in trip units.

They are designed for DC general-purpose applications.

The TM-DC 3P/4P trip units provide:

- adjustable thermal threshold
- adjustable magnetic pick-up

Description

The setting range and adjustment dials are on the front of the trip unit.

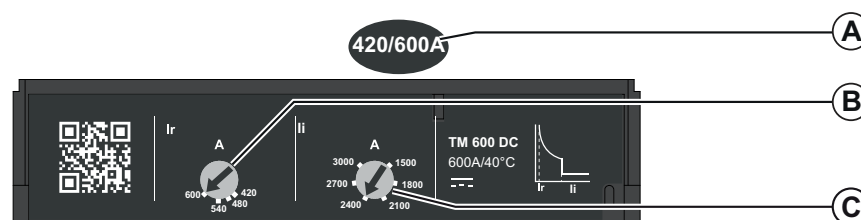

A Setting range for TM-DC thermal-magnetic 3P/4P trip unit

B Adjustment dial for the thermal protection pick-up I_r

C Adjustment dial for the magnetic protection pick-up I_i

Setting the Thermal Protection

The thermal protection pick-up I_r is set by a 5-setting dial.

Turning the thermal protection adjustment dial (A) modifies the trip curve as shown (B).

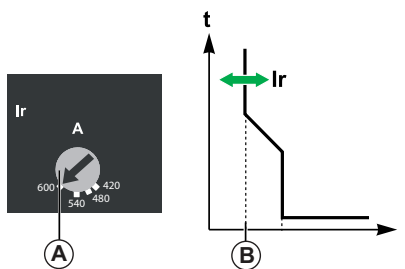

The following table shows the values of the pick-up I_r (in amperes) for thermal protection (values indicated on the dial) with respect to every trip unit rating, relative to the position of the dial I_r .

Trip Unit Rating I_n (A) at 40 °C (104 °F)				
250	320	400	500	600
Pick-up I_r (A) at 40 °C (104 °F)				
175	224	280	350	420
200	256	320	400	480
225	288	360	450	540
250	320	400	500	600

Setting the Magnetic Protection

The magnetic protection pick-up cannot be adjusted and equals the value shown below:

Trip Unit Rating I_n (A)				
250	320	400	500	600
Pick-up I_i (A) +/- 20%				
625	800	1000	1250	1500
750	960	1200	1500	1800
875	1120	1400	1750	2100
1000	1280	1600	2000	2400
1125	1440	1800	2250	2700
1250	1600	2000	2500	3000

TM-DC Thermal-Magnetic Trip Unit for 2P Circuit Breakers from 630 A to 1200 A

Introduction

The TM-DC thermal-magnetic trip unit for 2P circuit breakers from 630 A to 1200 A are built-in trip units.

They are designed for DC general-purpose applications.

The TM-DC 2P trip units provide:

- adjustable thermal threshold
- adjustable magnetic pick-up

Description

The setting range and adjustment dials are on the front of the trip unit.

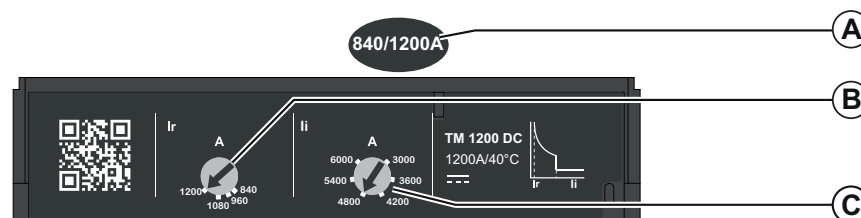

A Setting range for TM-DC thermal-magnetic 2P trip unit

B Adjustment dial for the thermal protection pick-up I_r

C Adjustment dial for the magnetic protection pick-up I_i

Setting the Thermal Protection

The thermal protection pick-up I_r is set by a 4-setting dial.

Turning the thermal protection adjustment dial (A) modifies the trip curve as shown (B).

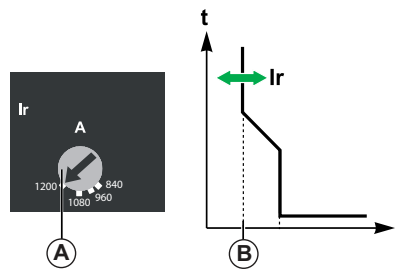

The following table shows the values of the pick-up I_r (in amperes) for thermal protection (values indicated on the dial) with respect to every trip unit rating, relative to the position of the dial I_r .

Trip Unit Rating I_n (A) at 40 °C (104 °F)			
630	800	1000	1200
Pick-up I_r (A) at 40 °C (104 °F)			
441	560	700	840
504	640	800	960
567	720	900	1080
630	800	1000	1200

Setting the Magnetic Protection

The magnetic protection pick-up cannot be adjusted and equals the value shown below:

Trip Unit Rating I_n (A)			
630	800	1000	1200
Pick-up I_i (A) +/- 20%			
1575	2000	2500	3000
1890	2400	3000	3600
2205	2800	3500	4200
2520	3200	4000	4800
2835	3600	4500	5400
3150	4000	5000	6000

TM-G Thermal-Magnetic Trip Unit for 3P and 4P Circuit Breakers up to 250 A

Introduction

The TM-G thermal-magnetic trip unit for 3P/4P circuit breakers up to 250 A are interchangeable trip units.

They are designed for DC general-purpose applications.

The TM-G interchangeable 3P/4P trip units provide:

- adjustable thermal threshold
- fixed magnetic pick-up

Description

The adjustment dial is on the front of the trip unit.

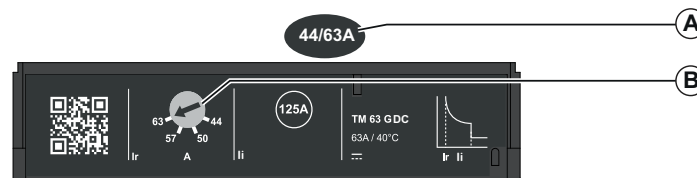

A Setting range for the TM-G thermal-magnetic trip unit

B Adjustment dial for the thermal protection pick-up I_r

Setting the Thermal Protection

The thermal protection pick-up I_r is set by a 4-setting dial.

Turning the thermal protection adjustment dial (**A**) modifies the trip curve as shown (**B**).

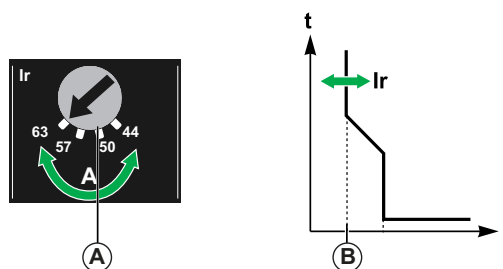

The following table shows the values of the pick-up I_r (in amperes) for thermal protection (values indicated on the dial) with respect to every trip unit rating, relative to the position of the dial I_r .

Trip Unit Rating I_n (A)									
16	25	40	63	80	100	125	160	200	250
Pick-up I_r (A)									
11	18	28	44	56	70	88	112	140	175
13	20	32	50	64	80	100	128	160	200
14	23	36	57	72	90	113	144	180	225
16	25	40	63	80	100	125	160	200	250

Setting the Magnetic Protection

The magnetic protection pick-up cannot be adjusted and equals the value shown below:

	Trip Unit Rating In (A)									
	16	25	40	63	80	100	125	160	200	250
	Fixed Pick-up Ii (A) +/- 20%									
AC value	63	80	80	125	200	320	440	440	440	520
DC value	80	100	100	150	240	380	530	530	530	620

TM-DC PV Thermal-Magnetic Trip Unit for 4P Circuit Breakers

Introduction

The TM-DC PV thermal-magnetic trip unit for 4P circuit breakers from 80 A to 500 A are built-in trip units.

They are designed for DC photovoltaic applications.

The TM-DC PV 4P trip units provide:

- adjustable thermal threshold
- fixed magnetic pick-up on trip units with I_n from 80 A to 160 A
- adjustable magnetic pick-up on trip units with I_n from 200 A to 500 A

Description

The setting range and adjustment dials are on the front of the trip unit.

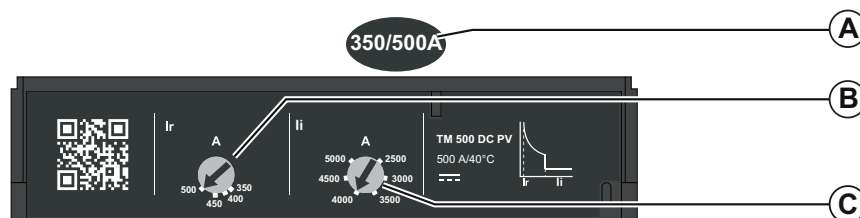

A Setting range for TM-DC PV thermal-magnetic trip unit

B Adjustment dial for the thermal protection pick-up I_r

C Adjustment dial for the magnetic protection pick-up I_i (on trip units with I_n from 200 A to 500 A only)

Setting the Thermal Protection

The thermal protection pick-up I_r is set by a 4-setting dial.

Turning the thermal protection adjustment dial (A) modifies the trip curve as shown (B).

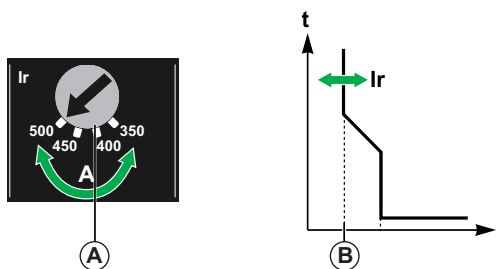

The following table shows the values of the pick-up I_r (in amperes) for thermal protection (values indicated on the dial) with respect to every trip unit rating, relative to the position of the dial I_r .

Trip Unit Rating I_n (A) at 40 °C (104 °F)								
80	100	125	160	200	250	320	400	500
Pick-up I_r (A) at 40 °C (104 °F)								
56	70	87	112	140	175	224	280	350
64	80	100	128	160	200	256	320	400
72	90	112	144	180	225	288	360	450
80	100	125	160	200	250	320	400	500

The thermal protection setting is fixed at the trip unit rating.

Setting the Magnetic Protection on Trip Units With I_n from 80 A to 160 A

For trip units rated below 200 A, the magnetic protection pick-up cannot be adjusted and equals the value shown below:

	Trip Unit Rating I_n (A)			
	80	100	125	160
Fixed Pick-up I_i (A) +/- 20%				
DC value	800	800	1,250	1,250

Setting the Magnetic Protection on Trip Units With In from 200 A to 500 A

For trip units rated between 200 A and 500 A, the magnetic protection pick-up I_i is set by a 6-setting dial.

Turning the magnetic protection adjustment dial (A) modifies the trip curve as shown (B).

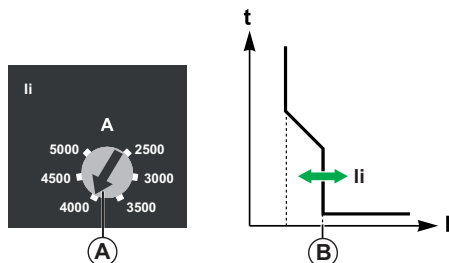

The following table shows the values of the pick-up I_i (in amperes) for magnetic protection (values indicated on the dial), relative to the position of the I_i dial:

Trip Unit Rating In (A)				
200	250	320	400	500
Pick-up I_i (A) +/- 20%				
1,000	1,250	1,600	2,000	2,500
1,200	1,500	1,920	2,400	3,000
1,400	1,750	2,240	2,800	3,500
1,600	2,000	2,560	3,200	4,000
1,800	2,250	2,880	3,600	4,500
2,000	2,500	3,200	4,000	5,000

TM-DC EP Thermal-Magnetic Trip Unit for 4P Circuit Breakers for 1500 Vdc Applications

Introduction

The TM-DC EP thermal-magnetic trip unit for 4P circuit breakers from 100 A to 500 A are built-in trip units.

They are designed for DC photovoltaic and marine applications.

The TM-DC EP 4P trip units provide:

- adjustable thermal threshold
- fixed magnetic pick-up on trip units with I_n from 100 A to 250 A
- adjustable magnetic pick-up on trip units with I_n from 250 A to 500 A

Description

The setting range and adjustment dials are on the front of the trip unit.

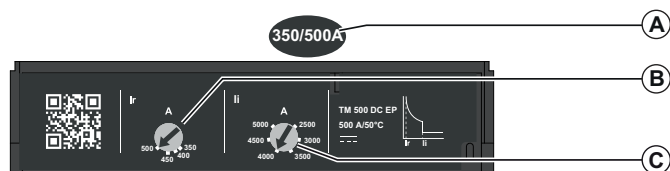

A Setting range for TM-DC EP thermal-magnetic trip unit

B Adjustment dial for the thermal protection pick-up I_r

C Adjustment dial for the magnetic protection pick-up I_i (on trip units with I_n from 250 A to 500 A only)

Setting the Thermal Protection

The thermal protection pick-up I_r is set by a 4-setting dial.

Turning the thermal protection adjustment dial (A) modifies the trip curve as shown (B).

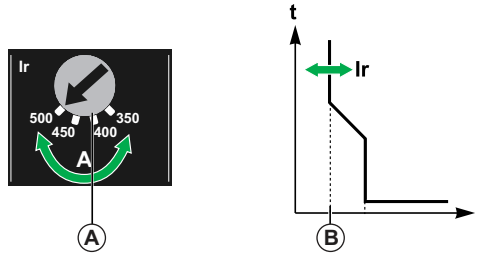

The following table shows the values of the pick-up I_r (in amperes) for thermal protection (values indicated on the dial) with respect to every trip unit rating, relative to the position of the dial I_r .

Trip Unit Rating I_n (A) at 50 °C (122 °F)								
250 A frame					500 A frame			
100	125	160	200	250	250	320	400	500
Pick-up I_r (A) at 50 °C (122 °F)								
70	87	112	140	175	175	224	280	350
80	100	128	160	200	200	256	320	400
90	112	144	180	225	225	288	360	450
100	125	160	200	250	250	320	400	500

The thermal protection setting is fixed at the trip unit rating.

Setting the Magnetic Protection on Trip Units With I_n from 100 A to 250 A

For trip units rated below 250 A, the magnetic protection pick-up cannot be adjusted and equals the value shown below:

	Trip Unit Rating I_n (A)				
	100	125	160	200	250
	Fixed Pick-up I_i (A) +/- 20%				
DC value	600	750	960	1,200	1,500

Setting the Magnetic Protection on Trip Units With In from 250 A to 500 A

For trip units rated between 250 A and 500 A, the magnetic protection pick-up I_i is set by a 6-setting dial.

Turning the magnetic protection adjustment dial (A) modifies the trip curve as shown (B).

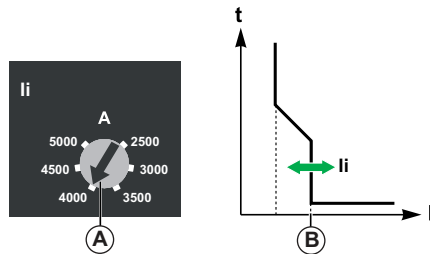

The following table shows the values of the pick-up I_i (in amperes) for magnetic protection (values indicated on the dial), relative to the position of the I_i dial:

Trip Unit Rating I_n (A)			
250	320	400	500
Pick-up I_i (A) +/- 20%			
1,250	1,600	2,000	2,500
1,500	1,920	2,400	3,000
1,750	2,240	2,800	3,500
2,000	2,560	3,200	4,000
2,250	2,880	3,600	4,500
2,500	3,200	4,000	5,000

Protection Against Ground Faults for Photovoltaic Applications

Introduction

Protection against ground faults in photovoltaic applications is provided by:

- insulation monitoring devices
- overcurrent ground fault protection

Double Ground Faults

To break a fault current at the operational photovoltaic system voltage, a minimum number of poles must be working in series. The minimum number of poles is a function of the system voltage and voltage rating per pole of the protective device (circuit breaker or switch-disconnector).

Under certain conditions, a double ground fault can occur in photovoltaic systems that are isolated from ground. If an initial ground fault (initial isolation breakdown to ground) exists, without being detected and cleared, a second fault (second isolation breakdown to ground) can lead to a double fault.

Depending on the location of the faults, it is possible that a subset number of the required poles only be involved in the interruption of the fault. Not designed for this situation, property damage or personal injury may occur.

To prevent such double fault scenarios, it is therefore imperative to detect the initial isolation breakdown (first fault) using an isolation monitoring system and clear without delay the initial isolation breakdown to reduce the risk of double fault.

ComPacT NSX DC Circuit Breakers Operation

What's in This Part

Commissioning	139
Maintaining the Circuit Breaker During Operation.....	143
Responding to a Trip	146
Troubleshooting	148

Commissioning

List of Checks and Inspections

DANGER

HAZARD OF ELECTRIC SHOCK, EXPLOSION, OR ARC FLASH

- Apply appropriate personal protective equipment (PPE) and follow safe electrical work practices. See NFPA 70E or CSA Z462 or local equivalent.
- This equipment must only be installed and serviced by qualified electrical personnel.
- Turn off all power supplying this equipment before working on or inside equipment.
- Always use a properly rated voltage sensing device to confirm that power is off.
- Put back all devices, doors, and covers before turning on power to this equipment.
- Repair the installation immediately if an insulation fault occurs during operation.

Failure to follow these instructions will result in death or serious injury.

When starting up new equipment, or following lengthy downtime, a general check takes just a few minutes. Such a check reduces the risk of a malfunction due to error or oversight.

The following table indicates the checks and inspections to be performed according to the event:

	A	B	C	D	E	F	G	H	I	J	K
Before commissioning	✓	✓	✓	✓	✓	✓	✓	✓	–	✓	✓
Periodically during operation, page 143	✓	–	–	–	✓	✓	✓	✓	✓	✓	✓
After carrying out work on the switchboard	–	✓	✓	✓	✓	✓	✓	✓	✓	✓	✓
Periodically during lengthy downtime	–	✓	✓	–	✓	✓	–	✓	–	✓	✓
Following lengthy downtime	–	✓	✓	–	✓	✓	✓	✓	✓	✓	✓
Following lengthy downtime and modification to the switchboard	✓	✓	✓	✓	✓	✓	✓	✓	✓	✓	✓

A Insulation and dielectric strength tests
B Temperature rise tests
C Inspect switchboard
D Check compliance with the diagram
E Inspect mechanical equipment
F Check connections
G Check mechanical operation
H Check trip units on devices
I Check pairing of the wireless devices with gateway or panel server
J Check communication
K Clean equipment

A: Insulation and Dielectric Strength Tests

▲ CAUTION

HAZARD OF EQUIPMENT DAMAGE

Insulation and dielectric strength tests must only be carried out by qualified electrical personnel.

Failure to follow these instructions can result in injury or equipment damage.

Insulation and dielectric strength tests are carried out before the switchboard is delivered. These tests are subject to the currently applicable standards.

These tests must be carried out periodically on photovoltaic 1,000 Vdc applications.

Dielectric strength tests impose great stress on the equipment and can cause damage if performed incorrectly. In particular:

- Reduce the value used for the test voltage according to the number of consecutive tests on the same piece of equipment
- Disconnect electronic equipment if necessary

B: Temperature Rise Tests

ComPacT NSX DC circuit breakers are designed to dissipate the temperature rise produced by the relatively short series of connections of the poles. This is especially important for photovoltaic applications where 4 poles in series (2 poles in series for each polarity) are required to break the rated current or fault current with all poles open at the open-circuit maximum voltage when it is equal to 1,000 Vdc.

Temperature rise tests are carried out before the switchboard is delivered. ComPacT NSX DC circuit breakers comply with product standards IEC 60947-1 and 2.

For general-purpose systems, the tests are carried out with an ambient temperature of 40 °C (104 °F). Above 40 °C (104 °F), overload protection characteristics are slightly modified and values defined in the derating tables must be taken into account. The values are valid for fixed and withdrawable circuit breakers with or without terminal shields.

For photovoltaic applications, the tests are carried out with

- an ambient temperature of 20 °C (68 °F)
- vertical mounting of fixed circuit breakers
- terminal shields (mandatory for all DC photovoltaic circuit breakers with rated voltage above 500 Vdc) heat sinks on top
- 4 cables on the bottom connections with section and length according to IEC 60947-1 Table 9:
 - when used in array boxes, with short connection to string protections, the cross section of the bars or cables must have a higher cross section
 - when cables have a cross section lower than the value indicated in the table, an additional 0.9 derating coefficient must be applied

C: Inspect Switchboard

Check that the circuit breakers are installed:

- In a clean environment without waste from assembling the equipment (such as wiring, tools, shavings, metallic particles)
- In a properly ventilated switchboard (unobstructed ventilation grilles)

D: Check Compliance with the Diagram

Check that the circuit breakers comply with the installation diagram:

- Identification of the feeds on the front of the circuit breakers
- Rating and breaking capacity (shown on the faceplate label)
- Identification of the trip units (type, rating)
- Presence of additional functions (motor mechanism, rotary handle, control or indication auxiliaries, locking, sealing)
- Protection settings: visually check the position of the adjustment dials on the trip unit

E: Inspect Mechanical Equipment

Visually inspect the general state of the circuit breaker. Check the following items:

- Terminal shields and interphase barriers
- Escutcheon
- Trip unit
- Case
- Chassis

Check the equipment integrity: a circuit breaker found with a cracked case or burn marks must be immediately taken out of service and replaced.

Check the mounting and mechanical strength:

- Of circuit breakers in the switchboard, and of power connections and heat sinks (torque: 50 N•m)
- Of auxiliaries and accessories on the circuit breakers:
 - Rotary handles or motor mechanisms
 - Installation accessories (such as terminal shields, interphase barriers, escutcheons)
- Of the chassis (withdrawable circuit breaker)
- Of locks, padlocks, and padlock support tabs

Photovoltaic application operating conditions involve various environmental stresses: wide temperature variations, humidity, and electrical stresses. In order to ensure performances of equipment during all the life cycle of installation, particular attention must be paid to the following:

- Enclosure integrity (double isolation IP level)
- Circuit breaker operating condition and integrity
 - to evaluate if any overheating has occurred
 - to examine circuit breakers for the presence of dust, moisture, and so on.
- Visual check of electrical connections
- Functional test of equipment and auxiliaries
- Insulation monitoring device test
- Insulation resistance test

F: Check Connections

Check the tightening torque of the power connections and auxiliary circuit connections, as described in the instruction sheets, page 7.

G: Check Mechanical Operation

Check the circuit breaker mechanical operation:

- Opening, closing and resetting
- Tripping with the push-to-trip button
- Tripping by MN/MX control auxiliaries
- Opening, closing, resetting by motor mechanism in automatic and manual mode

H: Check Trip Units on Devices

Check that the following are working correctly:

- OF, SD or SDE indication contacts
- Wireless indication auxiliaries

I: Check Pairing of Wireless Devices with Gateway or Panel Server

Check that wireless communication with gateway or panel server is working correctly for wireless indication auxiliaries, page 85. The LED is blinking green each time data is sent (every 8 hours, or when status changes).

J: Check Communication

Check that the communication via the communication network works correctly. Refer to DOCA0093EN *ULP System (IEC Standard) - User Guide*

K: Clean Equipment

To avoid dust deposits that can affect the circuit breaker mechanical operation, clean the circuit breakers when performing maintenance:

- For nonmetallic parts: always use a dry cloth. Do not use cleaning products.
- For metallic parts: preferably use a dry cloth. If a cleaning product must be used, do not apply or splash the product onto non-metallic parts.

This operation is especially important for the photovoltaic 1,000 Vdc applications.

Maintaining the Circuit Breaker During Operation

Introduction

The electrical switchboard and all its equipment continue to age whether they operate or not. This aging process is due mainly to environmental influences and operating conditions.

To help ensure that circuit breaker retains the operating and safety characteristics specified in the catalogue for the whole of its service life:

- Install the circuit breaker in optimum environmental and operating conditions (described in the following table).
- Have routine inspections and regular maintenance done by qualified electrical personnel.

Environmental and Operating Conditions

The environmental conditions previously described, page 24, refer to harsh operating environments.

The following table describes the optimum environmental and operating conditions:

Environmental and operating factor	Comments
Temperature	Average annual temperature outside the switchboard: < 25 °C (77 °F).
Loading	Loading remains < 80% of In 24 hours a day.
Harmonics	The harmonic current per phase is < 30% of In.
Humidity	The relative humidity is < 70%.
Corrosive atmosphere (SO ₂ , NH ₃ , H ₂ S, Cl ₂ , NO ₂)	Install the circuit breaker in environmental category 3C1 or 3C2 (IEC/EN 60721-3-3).
Saline environment	Install the circuit breaker in an environment free of salt mist.
Dust	The dust level is low: protect the circuit breaker within a switchboard fitted with filters or IP54 ventilated.
Vibration	Continuous vibration is < 0.2 g.

The maintenance programs apply to optimum environmental and operating conditions. Outside these limits circuit breakers are subject to accelerated aging which can quickly lead to malfunctions.

Regular Preventive Maintenance

Maintenance recommendations for each device are intended to maintain the equipment or subassemblies in a satisfactory operational state for their useful service life.

There are three recommended preventive maintenance programs:

- Basic end-user maintenance program
- Standard end-user maintenance program
- Manufacturer maintenance program

NOTE: Global service plans delivered by Schneider Electric may include maintenance plans for your equipment, with a different wording for maintenance levels:

- Basic end-user maintenance in this guide corresponds to Routine maintenance in service plans.
- Standard end-user maintenance in this guide corresponds to Intermediate maintenance in service plans.
- Manufacturer maintenance remains the same.

The following table summarizes maintenance operations for the three preventive maintenance programs:

Maintenance program	Maintenance description	Performed by
Basic end-user maintenance	Visual inspection and functional testing, replacement of inoperative accessories.	<ul style="list-style-type: none"> • Trained and qualified end-user personnel • Trained and qualified maintenance services provider personnel • Schneider Electric field service representative
Standard end-user maintenance	Basic end-user maintenance, plus operational servicing and subassembly tests.	<ul style="list-style-type: none"> • Trained and qualified maintenance services provider personnel • Schneider Electric field service representative
Manufacturer maintenance	Standard end-user maintenance, plus diagnostics and part replacements by Schneider Electric Services.	Schneider Electric field service representative

If all environmental conditions are more favorable than normal, maintenance intervals can be longer than the ones in normal environmental and operating conditions (for example, Standard end-user maintenance programs can be carried out every 3 years).

If any one of the conditions is more severe, perform maintenance more frequently. For advice, contact Schneider Electric Services.

Functions linked specifically to safety require particular maintenance intervals.

NOTE: Regularly test that the remote safety commands work. For example, test at least every six months.

Maintenance Operations Required

Inspection and servicing chiefly consist of checks and inspections A, E, F, G, and H as defined for the commissioning phase, page 139.

⚠ CAUTION
HAZARD OF EQUIPMENT DAMAGE
Insulation and dielectric strength tests must only be carried out by qualified electrical personnel.
Failure to follow these instructions can result in injury or equipment damage.

Maintenance operation mainly consists of checks and inspections A, D, E, F, G, I, and J as defined for the commissioning phase, page 139.

Letter - maintenance operation	Maintenance operation	Year 1	Year 2	Year 3	Year 4	Year 5
A	Insulation and dielectric strength tests, page 140	✓	✓	✓	✓	✓
E	Inspect mechanical equipment, page 141	✓	✓	✓	✓	✓
F	Check connections, page 141	✓	✓	✓	✓	✓
–	Measurement of insulation resistance	✓	✓	✓	✓	✓
G	Check mechanical operation, page 142 NOTE: Check tripping by MN/MX twice a year	✓	✓	✓	✓	✓
–	Replace MN/MX trip releases	–	–	–	–	✓
H	Check trip units, page 142	✓	✓	✓	✓	✓
J	Check communication, page 142	✓	✓	✓	✓	✓
–	Check the closing time, opening time and voltage release characteristics	✓	✓	✓	✓	✓
K	Clean equipment, page 142	✓	✓	✓	✓	✓

For a detailed definition of these operations, contact Schneider Electric Services.

Maintenance Following Short-Circuit Trip

Test a circuit breaker in severe conditions, in accordance with standard IEC/EN 60947-2, to check that it can break a short-circuit current at maximum permissible value three times.

After a short-circuit fault, it is necessary to:

- Carefully clean off any traces of black smoke (the particles may be conducting)
- Check the power connections and control wires
- Operate the circuit breaker several times at no load (at least 5 times)

Replacement of Electric Auxiliary Devices in Photovoltaic Circuit Breakers

Special care is required when adding electric auxiliary devices into circuit breakers for photovoltaic applications.

⚡ ⚠ DANGER

HAZARD OF ELECTRIC SHOCK, EXPLOSION OR ARC FLASH

- Isolate the circuit breaker upstream and downstream before removing the front cover.
- Always use a properly rated voltage sensing device to confirm that power is off.
- Replace the front cover before turning on power to this equipment.

Failure to follow these instructions will result in death or serious injury.

Responding to a Trip

Taking Precautions Before Responding to a Trip

 **DANGER**

HAZARD OF ELECTRIC SHOCK, EXPLOSION, OR ARC FLASH

- Apply appropriate personal protective equipment (PPE) and follow safe electrical work practices. See NFPA 70E or CSA Z462 or local equivalent.
- This equipment must only be installed and serviced by qualified electrical personnel.
- Turn off all power supplying this equipment before working on or inside equipment.
- Always use a properly rated voltage sensing device to confirm that power is off.
- Put back all devices, doors, and covers before turning on power to this equipment.
- Repair the installation immediately if an insulation fault occurs during operation.

Failure to follow these instructions will result in death or serious injury.

Identifying the Cause of the Trip

Local and remote indication provides information on the probable cause of a trip.

The causes are of several types:

- Faults detected on the installation
- Faults detected due to a malfunction
- Intentional tripping

Trip Following a Fault on the Installation

The control mechanism is positioned on , or Trip.

Indication	Probable cause
SD	Tripped manually by: <ul style="list-style-type: none"> • Push-to-trip test • Manually opening the motor mechanism • Disconnecting the circuit breaker • MN or MX trip releases
SD and SDE	Tripped on electrical fault, cause unknown

Maintenance of the Equipment Following Trip on Electrical Fault

The fact that the protection has tripped does not remedy the cause of the fault on the downstream equipment.

▲ WARNING**HAZARD OF CLOSING ON ELECTRICAL FAULT**

Do not close the circuit breaker again without first inspecting and, if necessary, repairing the downstream electrical equipment.

Failure to follow these instructions can result in death, serious injury, or equipment damage.

Isolate the feed before inspecting the electrical equipment downstream of the protection.

Perform the following tasks after a short-circuit:

- Carefully clean off any traces of black smoke. The smoke particles can conduct electricity.
- Check the power connections and control wires.
- Operate the circuit breaker at least five times at zero load.

Depending on the type of fault, perform maintenance inspections, page 139 on all or part of the equipment where the fault occurred:

- Minor faults: Tripped by overload protection
Following repairs, checks E, F, and G must be carried out.
- Serious or destructive faults:
 - Tripped due to unknown electrical fault
 - Tripped by short-circuit protection
 - Tripped by ground-fault protection

Special care must be taken to prevent double ground faults in photovoltaic applications, page 137.

Following repairs, checks A, D, E, G, and J must be carried out. Check the circuit breaker that tripped, page 143 before being returned to service.

NOTE: Checks, tests, and inspections must be carried out by qualified electrical personnel.

If restarting is a high priority (for example, a safety installation), the defective part of the installation must be isolated and locked in order to carry out this maintenance.

Troubleshooting

Introduction

Troubleshooting operations are described in the following tables, with the checks or repairs to be carried out in relation to the probable causes of the malfunction indicated. They are classified into the following events:

- Repetitive tripping
- Circuit breaker fails to close (manually operated circuit breaker)
- Circuit breaker fails to close (motor-operated circuit breaker)

Repetitive Tripping

Indication	Probable cause	Checks or repairs
SD	Supply voltage to the MN undervoltage trip release is too low or subject to significant variations	Check the power supply for the release (for example, a supply powering motors with high-power ratings may be unstable). If so, connect the release to a clean or stable supply.
	Supply voltage to an MX shunt trip release applied unintentionally	Check that the release connection is correct compared to the installation diagram.
SD and SDE	Operating temperature too high	Check the switchboard ventilation and the temperature in the room.

Circuit Breaker Fails to Close (Manually Operated Circuit Breaker)

The following table shows the checks or repairs to be carried out in relation to the probable causes of the malfunction indicated.

Indication	Probable cause	Checks or repairs
SD	MX shunt trip release energized MN undervoltage trip release not energized	Check that the release connection is correct compared to the installation diagram.
OF	Circuit breaker interlocked	Check the installation and interlock diagram (mechanical or electrical) for both circuit breakers.

Circuit Breaker Fails to Close (Motor-Operated Circuit Breaker)

The following table shows the checks or repairs to be carried out in relation to the probable causes of the malfunction indicated.

Indication	Probable cause	Checks or repairs
OF	Close instruction not operational	<p>Check the Auto position of the selector on the front of the circuit breaker.</p> <p>Also check:</p> <ul style="list-style-type: none"> • The power supply to the motor mechanism, the motor voltage • The voltage at the motor terminals on the motor mechanism • The close command path

Appendix

What's in This Part

BSCM Module With Commercial Reference LV434205	151
--	-----

BSCM Module With Commercial Reference LV434205

Introduction

The BSCM module with commercial reference LV434205 is substituted by the BSCM Modbus SL/ULP module with commercial reference LV434220.

The following table shows the specificities for each BSCM module.

Characteristics	BSCM module with commercial reference LV434205	BSCM Modbus SL/ULP module with commercial reference LV434220
Connectivity	Can communicate via a ULP system	Can communicate via a ULP system and via a Modbus communication network
NSX cord mandatory	Yes	No
SD status availability	Always available (via NSX cord)	Available when NSX cord or SD auxiliary contact for BSCM Modbus SL/ULP module is connected
Communication interface required	IFM or IFE communication interface	Acts as a communication interface module

The BSCM Breaker Status Control Module can be used to send the following data via the communication network:

- Circuit breaker states from OF, SD, and SDE auxiliary contacts
- Control instructions for the communicating motor mechanism (if present): opening, closing, and resetting
- Information to assist the operator: storage of the last 10 events

Use the BSCM module with ComPacT NSX DC circuit breakers equipped with thermal-magnetic trip units, and with ComPacT NSX DC switch-disconnectors.

NOTE: The BSCM module cannot be installed in a ComPacT NSX DC EP circuit breaker.

Installation of the BSCM module requires:

- The NSX cord
- Pre-installation of the communicating motor mechanism (if present)

For more information about integrating ComPacT NSX circuit breaker communication functions, refer to:

- DOCA0093•• *ULP System (IEC Standard) - User Guide*, page 7
- DOCA0213•• *ComPacT NSX - Modbus Communication Guide*, page 7

Description

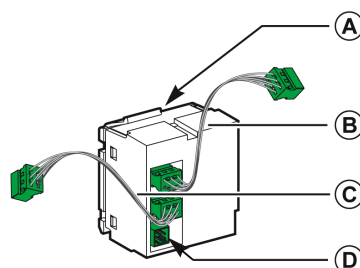

Item	Data medium	Data transmitted	Comments
A	BSCM module microswitches	State of OF and SDE contacts	The BSCM module takes the place of the auxiliary contacts in the OF and SDE slots.
B	Connector for the NSX cord	Communication network and state of SD contact through the microswitch on the NSX cord	The NSX cord goes in the SD slot instead of the auxiliary contact.
C	Connector for the MicroLogic 5, 6, or 7 trip units	Communication network	Not used with ComPacT NSX DC circuit breakers.
D	Connector for the communicating motor mechanism	Controlling the communicating motor mechanism Status of the communicating motor mechanism	Use the connector supplied with the communicating motor mechanism.

Installing the BSCM Module

The slots used to install the BSCM module depend on the circuit breaker type.

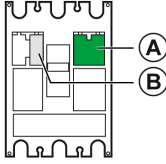
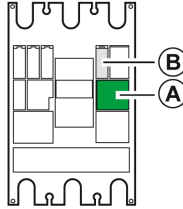
ComPacT NSX100-250 DC 3P/4P	ComPacT NSX400-630 DC 3P/4P ComPacT NSX1200 DC 2P
	
<p>A BSCM module</p> <p>B NSX cord</p>	

The BSCM module cannot be installed at the same time as an OF contact or the SDE contact.

The BSCM module can be installed on site.

For more information about installation, consult the instruction sheet on the Schneider Electric website: [GHD16046AA ComPacT NSX DC – BSCM](https://www.se.com/ww/en/answers/GHD16046AA-ComPacT-NSX-DC-BSCM).

Connecting the BSCM Module







To install the BSCM module:

- Plug in the module.
- Connect the connectors.

Setting Up the BSCM Module

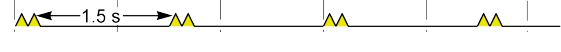
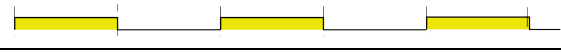
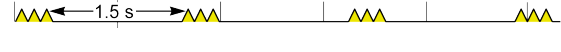
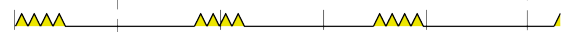
Setting up the BSCM module on the communication network requires no addressing.

LED Indication on BSCM Module

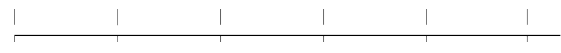
ULP LED	Mode	Action
	Nominal	None
	Conflict	Remove extra ULP module
	Degraded	Replace BSCM module at the next maintenance operation
	Test	None
	Non-critical firmware discrepancy	Upgrade firmware at the next maintenance operation
	Non-critical hardware discrepancy	Replace BSCM module at the next maintenance operation
	Configuration discrepancy	Install missing features
	Critical firmware discrepancy	Use EcoStruxure Power Commission software to check the firmware and hardware compatibility and follow the recommended actions
	Critical hardware discrepancy	
	Stop	Replace BSCM module
	Power off	Check power supply

Data Provided by the BSCM Module

Configuration	Information	Can be reset
All circuit breakers with BSCM module	Count of the total number of times the circuit breaker opens and closes (count of OF contact operations). This counter (totalizer) cannot be reset.	No
	Count of the total number of times the circuit breaker opens and closes (count of OF contact operations) ⁽¹⁾	Yes
	Maximum number of times the circuit breaker can open and close ⁽²⁾	Yes
	Count of the number of fault trips by the circuit breaker (count of SD contact operations) ⁽¹⁾	Yes
	Count of the number of electrical fault trips by the circuit breaker (count of SDE contact operations) ⁽¹⁾	Yes

Configuration	Information	Can be reset
Circuit breakers with BSCM module and communicating motor mechanism	Count of the number of times the communicating motor mechanism opens ⁽¹⁾	No
	Count of the number of times the communicating motor mechanism closes ⁽¹⁾	Yes
	Maximum number of times the communicating motor mechanism closes ⁽²⁾	Yes
	Count of the number of times the communicating motor mechanism resets ⁽¹⁾	Yes
<p>(1) The user can modify the content of the counter if, for example, the BSCM module is installed or replaced during operation.</p> <p>(2) Overshooting the threshold results in a medium priority alarm. To acknowledge the alarm, modify the content of the counter or the value of the threshold.</p>		

Configuring the BSCM Module

To configure the BSCM module, use a PC running EcoStruxure Power Commission software and connected to the USB maintenance interface.

The USB maintenance interface must be connected to the RJ45 connector of a ULP module (for example, IFM Modbus SL communication interface).

With EcoStruxure Power Commission software, you can configure:

- The maximum number of times the circuit breaker can open and close.
- The maximum number of times the communicating motor mechanism can close.
- The reset mode of the communicating motor mechanism.

Configuring the Resetting of the Communicating Motor Mechanism

⚠ CAUTION

HAZARD OF REPEATED CLOSING ON ELECTRICAL FAULT

Reconfiguring of the BSCM Breaker Status Control Module must be done only by qualified electrical personnel.

Failure to follow these instructions can result in injury or equipment damage.

The reset mode of the communicating motor mechanism can be configured using the EcoStruxure Power Commission software:

- **Enable Reset even if SDE** to authorize resetting of the mechanism using the communication network even after an electrical fault trip.
- **Enable Automatic Reset** to authorize automatic resetting after tripping by the MN, MX trip release, or push-to-trip button.
- **Enable Reset even if SDE** and **Enable Automatic Reset** to authorize automatic resetting even after an electrical fault trip.

Index

A

accessory slots	78–79
auxiliaries contacts	
control	90
auxiliary contacts	
operation	81
auxiliary devices	76

B

BSCM	
configuration	154
connection	152
data provided	153
data sent	154
description	151
installation	152
setup	152
BSCM Modbus SL/ULP	
configuration	102
description	94
installation	96
setup	102, 104

C

carriage switches	72
checks	
commissioning	139
circuit breaker	
close	29
locking	33
open	29
reset	29
testing	22, 31
circuit breakers	
accessory slots	78–79
commissioning	139
functions	12
maintenance	143
motor operated	50
operation	138
plug-in	62
close	29
motor mechanism	53
rotary handle	38
connection	
plug-in circuit breakers	64
withdrawable circuit breakers	69
control contacts	90

D

disconnecting plug-in circuit breakers	63
disconnecting withdrawable circuit breakers	67

E

electrical accessories	60
------------------------------	----

I

indication contacts	
accessory slots	78–79
operation	81

L

locking	
circuit breaker	33

M

Modbus SL hub	
description	114
installation	114

O

open	29
------------	----

P

plug-in circuit breakers	62
connection	64
direct contact protection	65
disconnection	63

R

removing withdrawable circuit breakers	68
reset	29

S

SD auxiliary contact for BSCM Modbus SL/ULP module	
description	112
installation	112
sealing accessories	34
servicing	
at installation	21
setting	23
trip unit	23

T

testing	
circuit breaker	22, 31

W

wireless indication auxiliary	
operation	81
withdrawable circuit breakers	
connection	69
disconnection	67
removal	68

Schneider Electric
35 rue Joseph Monier
92500 Rueil Malmaison
France

+ 33 (0) 1 41 29 70 00

www.se.com

As standards, specifications, and design change from time to time,
please ask for confirmation of the information given in this publication.

© 2022 – 2024 Schneider Electric. All rights reserved.

DOCA0186EN-02