

PacT Series

ComPacT NSX MicroLogic 5/6/7 Electronic Trip Units

User Guide

PacT Series offers world-class breakers and switches

DOCA0188EN-03
06/2024

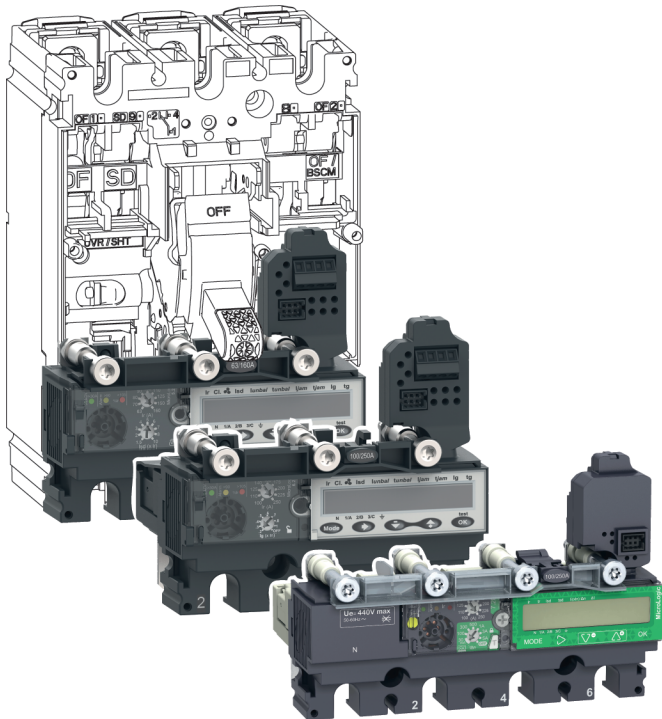

Legal Information

The information provided in this document contains general descriptions, technical characteristics and/or recommendations related to products/solutions.

This document is not intended as a substitute for a detailed study or operational and site-specific development or schematic plan. It is not to be used for determining suitability or reliability of the products/solutions for specific user applications. It is the duty of any such user to perform or have any professional expert of its choice (integrator, specifier or the like) perform the appropriate and comprehensive risk analysis, evaluation and testing of the products/solutions with respect to the relevant specific application or use thereof.

The Schneider Electric brand and any trademarks of Schneider Electric SE and its subsidiaries referred to in this document are the property of Schneider Electric SE or its subsidiaries. All other brands may be trademarks of their respective owner.

This document and its content are protected under applicable copyright laws and provided for informative use only. No part of this document may be reproduced or transmitted in any form or by any means (electronic, mechanical, photocopying, recording, or otherwise), for any purpose, without the prior written permission of Schneider Electric.

Schneider Electric does not grant any right or license for commercial use of the document or its content, except for a non-exclusive and personal license to consult it on an "as is" basis.

Schneider Electric reserves the right to make changes or updates with respect to or in the content of this document or the format thereof, at any time without notice.

To the extent permitted by applicable law, no responsibility or liability is assumed by Schneider Electric and its subsidiaries for any errors or omissions in the informational content of this document, as well as any non-intended use or misuse of the content thereof.

Table of Contents

Safety Information.....	5
About the Book.....	7
Using MicroLogic Trip Units.....	9
Range of MicroLogic Trip Units	10
Description of the MicroLogic 5 and 6 Trip Units	15
Description of the MicroLogic 7 Trip Unit with Integrated Earth-Leakage Protection	18
Description of the BSCM Modbus SL/ULP Module	22
MicroLogic Trip Unit Power Supply.....	24
Navigation Principles	28
Readout Mode.....	30
Setting of the MicroLogic Protection Functions.....	36
Setting of the BSCM Modbus SL/ULP Module (Micrologic 5/6 Trip Units Only)	40
Metering Screens	43
Protection Function Screens.....	44
EcoStruxure Power Commission Software	50
Password Management	52
Firmware Update.....	54
Protection Function.....	55
Electrical Distribution Application	56
Electrical Distribution Protection.....	57
Long-Time Protection	61
Short-Time Protection	64
Instantaneous Protection.....	67
Ground-Fault Protection	68
Earth-Leakage Protection	71
Neutral Protection	76
Zone Selective Interlocking (ZSI).....	79
Using the ZSI Function with ComPacT NSX Circuit Breakers	80
Motor-Feeder Application	82
Protection for Motor-Feeders	83
Long-Time Protection	88
Short-Time Protection	91
Instantaneous Protection.....	92
Ground-Fault Protection	93
Phase Unbalance Protection.....	96
Motor Jam Protection	99
Underload Motor Protection	101
Long-Start Motor Protection	103
Metering Function	106
Measurement Techniques	107
Real-Time Measurements	108
Calculating Demand Values	112
Power Metering	115
Power Calculation Algorithm.....	118
Energy Metering	121

Harmonic Currents.....	123
Metering Energy Quality Indicators	126
Power Factor PF and cos ϕ Measurement	128
Measurement Accuracy Tables	132
Measurement Accuracy.....	133
Real-Time Measurements	134
Demand Value Measurements	138
Energy Metering	139
Alarms.....	140
Alarms Associated with Measurements	141
Alarms on a Trip, Failure, and Maintenance Event.....	145
Tables of Alarms.....	146
Operation of SDx and SDTAM Module Outputs Assigned to Alarms.....	150
Operating Assistance	154
LED Indication	155
Indication on the MicroLogic Display	157
Examples of Using Alarms	163
Alarm Monitoring of the cos ϕ and Power Factor	164
Circuit Breaker Communication	167
History and Time-Stamped Information	169
Maintenance Indicators	170
Appendices	171
Additional Characteristics.....	172
ComPacT NSX100-250 - Distribution Protection.....	173
ComPacT NSX100-250 - Motor-Feeder Protection	174
ComPacT NSX400-630 - Distribution Protection.....	175
ComPacT NSX400-630 - Motor-Feeder Protection	176
ComPacT NSX100-630 - Reflex Tripping	177
ComPacT NSX100-630 - Limitation Curves	178

Safety Information

Important Information

Read these instructions carefully, and look at the equipment to become familiar with the device before trying to install, operate, service, or maintain it. The following special messages may appear throughout this documentation or on the equipment to warn of potential hazards or to call attention to information that clarifies or simplifies a procedure.



The addition of this symbol to a “Danger” or “Warning” safety label indicates that an electrical hazard exists which will result in personal injury if the instructions are not followed.



This is the safety alert symbol. It is used to alert you to potential personal injury hazards. Obey all safety messages that follow this symbol to avoid possible injury or death.

DANGER

DANGER indicates a hazardous situation which, if not avoided, **will result in death or serious injury**.

WARNING

WARNING indicates a hazardous situation which, if not avoided, **could result in death or serious injury**.

CAUTION

CAUTION indicates a hazardous situation which, if not avoided, **could result in minor or moderate injury**.

NOTICE

NOTICE is used to address practices not related to physical injury.

Please Note

Electrical equipment should be installed, operated, serviced, and maintained only by qualified personnel. No responsibility is assumed by Schneider Electric for any consequences arising out of the use of this material.

A qualified person is one who has skills and knowledge related to the construction and operation of electrical equipment and its installation, and has received safety training to recognize and avoid the hazards involved.

Cybersecurity Safety Notice

⚠ WARNING

POTENTIAL COMPROMISE OF SYSTEM AVAILABILITY, INTEGRITY, AND CONFIDENTIALITY

- Change default passwords at first use to help prevent unauthorized access to device settings, controls, and information.
- Disable unused ports/services and default accounts to help minimize pathways for malicious attackers.
- Place networked devices behind multiple layers of cyber defenses (such as firewalls, network segmentation, and network intrusion detection and protection).
- Use cybersecurity best practices (for example, least privilege, separation of duties) to help prevent unauthorized exposure, loss, modification of data and logs, or interruption of services.

Failure to follow these instructions can result in death, serious injury, or equipment damage.

About the Book

PacT Series Master Range

Future-proof your installation with Schneider Electric's low-voltage and medium-voltage PacT Series. Built on legendary Schneider Electric innovation, the PacT Series comprises world-class circuit breakers, switches, residual current devices and fuses, for all standard and specific applications. Experience robust performance with PacT Series within the EcoStruxure-ready switchgear, from 16 to 6300 A in low-voltage and up to 40.5 kV in medium-voltage.

Document Scope

The aim of this guide is to provide users, installers, and maintenance personnel with the technical information needed to operate the MicroLogic™ trip units in ComPacT™ NSX circuit breakers.

Validity Note

This guide is applicable to the trip units:

- MicroLogic 5.2 E, and 5.3 E
- MicroLogic 6.2 E, and 6.3 E
- MicroLogic 6.2 E-M and 6.3 E-M
- MicroLogic 7.2 E and 7.3 E with integrated earth-leakage
- MicroLogic 7.2 E-AL and 7.3 E-AL with integrated earth-leakage

For information on the other trip units in the MicroLogic range and the thermal-magnetic trip units on ComPacT NSX circuit breakers, refer to DOCA0187•• *ComPacT NSX - Circuit Breakers and Switch-Disconnectors 100–630 A - User Guide*, page 7.

Online Information

The information contained in this guide is likely to be updated at any time. Schneider Electric strongly recommends that you have the most recent and up-to-date version available on www.se.com/ww/en/download.

The technical characteristics of the devices described in this guide also appear online. To access the information online, go to the Schneider Electric home page at www.se.com.

Related Documents

Title of Documentation	Reference Number
<i>ComPacT NSX & NSXm Catalogue</i>	LVPED221001EN
<i>ComPacT NSX - Circuit Breakers and Switch-Disconnectors 100–630 A - User Guide</i>	DOCA0187EN DOCA0187ES DOCA0187FR DOCA0187ZH
<i>ComPacT NSX - Modbus Communication Guide</i>	DOCA0213EN DOCA0213ES

Title of Documentation	Reference Number
	DOCA0213FR DOCA0213ZH
<i>Enerlin'X IO – Input/Output Application Module for One IEC Circuit Breaker – User Guide</i>	DOCA0055EN DOCA0055ES DOCA0055FR DOCA0055ZH
<i>Enerlin'X IFE – Ethernet Interface for One IEC Circuit Breaker – User Guide</i>	DOCA0142EN DOCA0142ES DOCA0142FR DOCA0142ZH
<i>Enerlin'X IFE – Ethernet Switchboard Server – User Guide</i>	DOCA0084EN DOCA0084ES DOCA0084FR DOCA0084ZH
<i>Enerlin'X FDM121 - Front Display Module for One Circuit Breaker - User Guide</i>	DOCA0088EN DOCA0088ES DOCA0088FR DOCA0088ZH
<i>ULP System (IEC Standard) – ULP (Universal Logic Plug) System – User Guide</i>	DOCA0093EN DOCA0093ES DOCA0093FR DOCA0093ZH
<i>Service Interface - User Guide</i>	DOCA0170EN DOCA0170ES DOCA0170FR DOCA0170ZH
<i>ComPacT NSX - MicroLogic 5/6 Trip Unit - Firmware Release Notes</i>	DOCA0153EN
<i>ComPacT NSX - MicroLogic 7 Trip Unit - Firmware Release Notes</i>	DOCA0154EN
<i>MicroLogic Trip Units and Control Units - Firmware History</i>	DOCA0155EN

To find documents online, visit the Schneider Electric download center (www.se.com/ww/en/download/).

Information on Non-Inclusive or Insensitive Terminology

As a responsible, inclusive company, Schneider Electric is constantly updating its communications and products that contain non-inclusive or insensitive terminology. However, despite these efforts, our content may still contain terms that are deemed inappropriate by some customers.

Using MicroLogic Trip Units

What's in This Part

Range of MicroLogic Trip Units.....	10
Description of the MicroLogic 5 and 6 Trip Units.....	15
Description of the MicroLogic 7 Trip Unit with Integrated Earth-Leakage Protection	18
Description of the BSCM Modbus SL/ULP Module	22
MicroLogic Trip Unit Power Supply	24
Navigation Principles	28
Readout Mode	30
Setting of the MicroLogic Protection Functions	36
Setting of the BSCM Modbus SL/ULP Module (Micrologic 5/6 Trip Units Only)	40
Metering Screens	43
Protection Function Screens	44
EcoStruxure Power Commission Software	50
Password Management	52
Firmware Update	54

Range of MicroLogic Trip Units

Presentation

MicroLogic trip units are used on the ComPacT NSX circuit breakers. The range of MicroLogic trip units consists of several families of electronic trip unit:

- MicroLogic 1, 2, trip units, without display
- MicroLogic Vigi 4 trip units with earth-leakage protection, without display
- MicroLogic 5, 6, trip units with display
- MicroLogic Vigi 7 trip units with earth-leakage protection, with display

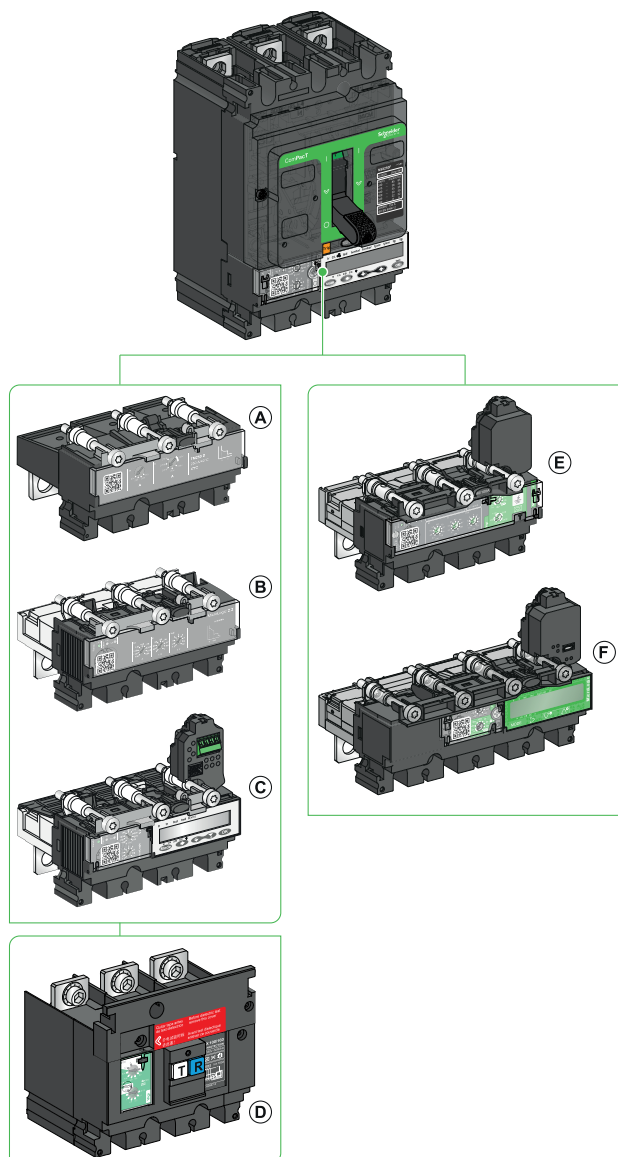

A TM-D, TM-G, or MA trip unit

B MicroLogic 1 or 2 trip unit

C MicroLogic 5 or 6 trip unit

D VigiPacT Add-on for additional earth-leakage protection or VigiPacT Add-on Alarm

E MicroLogic 4 trip unit with integrated earth-leakage protection

F MicroLogic 7 trip unit with integrated earth-leakage protection

Description of the MicroLogic 1, 2, and Vigi 4 Trip Units

MicroLogic trip units are grouped by application. A distinction is made between electrical power distribution applications and motor protection applications:

- In the electrical power distribution application:
 - MicroLogic 2.2 and 2.3 trip units are designed to protect conductors in commercial and industrial electrical distribution.
 - MicroLogic 4.2 and 4.3 trip units with integrated earth-leakage protection are designed to protect electrical conductors, goods, and people in commercial and industrial electrical distribution (MicroLogic 4.2 AL and 4.3 AL trip units with integrated earth-leakage protection are designed to measure earth-leakage current).
- In the motor protection application:
 - MicroLogic 1.3 M trip units are adapted to short-circuit protection of motor-feeders.
 - MicroLogic 2.2 M and 2.3 M trip units are adapted to protecting motor-feeders on standard applications. The thermal tripping curves are calculated for self-cooled motors.

The adjustment dials and indications are on the front face.

For more information about MicroLogic 1, 2, and 4 trip units, refer to DOCA0187•• *ComPacT NSX - Circuit Breakers and Switch-Disconnectors 100–630 A - User Guide*, page 7.

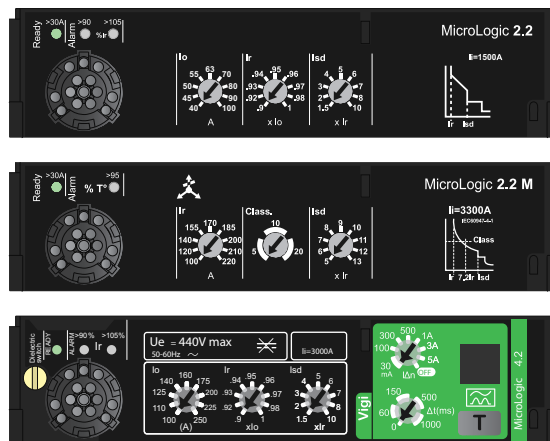

Description of the MicroLogic 5, 6, and Vigi 7 Trip Units

MicroLogic 5, 6, and Vigi 7 trip units are available for electrical power distribution applications and motor protection applications:

- In the electrical power distribution application, MicroLogic 5.2, 5.3, 6.2, 6.3, Vigi 7.2, and Vigi 7.3 trip units are designed to protect conductors, goods, and people in commercial and industrial electrical distribution.
- In the motor protection application, MicroLogic 6.2 M and 6.3 M trip units are adapted to protecting motor-feeders on standard applications. The thermal tripping curves are calculated for self-cooled motors.

MicroLogic 5, 6, and Vigi 7 trip units provide:

- Adjustable tripping functions on electronic trip circuit breakers
- Protection for the electrical distribution system or specific applications
- Metering of instantaneous and demand values
- Kilowatt-hour metering
- Operating information (such as peak demand values, customized alarms, operation counters)

- Communication

MicroLogic trip units can be configured to communicate with other devices. For information on the maintenance and communication modules, refer to the following documents:

- LVPED221001EN *ComPacT NSX & NSXm Catalogue*, page 7
- DOCA0187•• *ComPacT NSX - Circuit Breakers and Switch-Disconnectors 100–630 A - User Guide*, page 7

For complete information on available circuit breaker models, frame sizes, interrupting ratings, and trip units, refer to LVPED221001EN *ComPacT NSX & NSXm Catalogue*.





Identification

The product name specifies the protection provided by the trip unit.

MicroLogic 6.3 E-M



Identification on MicroLogic electronic trip units

Examples	Type of protection (X)	Case (Y)	Type of measurement (Z)	Application (T)
–	 1 SI 2 LS ₀ I 4 LS ₀ IR 5 LSI 6 LSIG 7 LSIR	 2 ComPacT NSX 100/160/250 3 ComPacT NSX 400/630	 E Energy	 Distribution G Generator AB Subscriber M Motor Z 16 Hz 2/3 AL Alarm without trip for earth-leakage protection
MicroLogic 1.3 M	SI	400 or 630 A	–	Motor
MicroLogic 2.2 G	LS ₀ I	100, 160 or 250 A	–	Generator
MicroLogic 2.3	LS ₀ I	400 or 630 A	–	Distribution
MicroLogic 2.3 M	LS ₀ I	400 or 630 A	–	Motor
MicroLogic Vigi 4.2	LS ₀ IR	100, 160 or 250 A	–	Distribution including trip on earth-leakage
MicroLogic Vigi 4.3 AL	LS ₀ I	400 or 570 A	–	Distribution including alarm on earth-leakage
MicroLogic 5.3 E	LSI	400 or 630 A	Energy	Distribution
MicroLogic 6.3 E-M	LSIG	400 or 630 A	Energy	Motor
MicroLogic Vigi 7.2 E-AL	LSI	100, 160 or 250 A	Energy	Distribution including alarm on earth-leakage
MicroLogic Vigi 7.3 E	LSIR	400 or 600 A	Energy	Distribution including trip on earth-leakage
Type of protection: I Instantaneous L Long-time S ₀ Short-time (time delay cannot be adjusted)				
S Short-time G Ground-fault R Earth-leakage (residual)				

In Rating

The trip unit In value is visible on the front face of the circuit breaker when the trip unit is installed. The trip unit In rating (in amperes) is the maximum value of the trip unit.

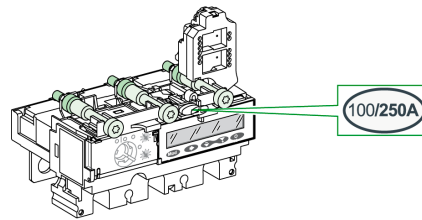

Example: MicroLogic 5.2 E 250 A trip unit:

- Setting range: 100–250 A
- In rating = 250 A

Integrating MicroLogic Trip Units on the ComPacT NSX Range of Circuit Breakers

MicroLogic trip units for electrical distribution can be used on any ComPacT NSX circuit breaker.

The following table indicates configurations available according to the In rating of the distribution trip unit and the circuit breaker size:

MicroLogic In rating	40	100	160	250	400	630
ComPacT NSX100	✓	✓	–	–	–	–
ComPacT NSX160	✓	✓	✓	–	–	–
ComPacT NSX250	✓	✓	✓	✓	–	–
ComPacT NSX400	–	–	–	✓ ⁽¹⁾	✓	–
ComPacT NSX630	–	–	–	✓ ⁽¹⁾	✓	✓
(1) MicroLogic 2.3 only						

MicroLogic 2 M or 6 E-M trip units can be used on any ComPacT NSX circuit breaker.

The following table indicates configurations available according to the In rating of the motor trip unit and the circuit breaker size:

MicroLogic M In rating	25	50	80	100	150	220	320	500
ComPacT NSX100	✓	✓	✓ ⁽¹⁾	✓ ⁽²⁾	–	–	–	–
ComPacT NSX160	✓	✓	✓ ⁽¹⁾	✓ ⁽²⁾	✓	–	–	–
ComPacT NSX250	✓	✓	✓ ⁽¹⁾	✓ ⁽²⁾	✓	✓	–	–
ComPacT NSX400	–	–	–	–	–	–	✓	–
ComPacT NSX630	–	–	–	–	–	–	✓	✓
(1) MicroLogic 6 E-M only								
(2) MicroLogic 2 M only								

MicroLogic 1.3 M trip units can be used on ComPacT NSX400 and ComPacT NSX630 circuit breakers.

The following table indicates configurations available according to the In rating of the motor trip unit and the circuit breaker size:

MicroLogic 1.3 M In rating	320	500
ComPacT NSX400	✓	–
ComPacT NSX630	✓	✓

Interchangeability of MicroLogic Trip Units

Onsite replacement of trip units is simple:

- No connections to make
- No special tools (for example, calibrated torque wrench)
- Compatibility of trip units provided by mechanical cap
- Torque limited screw provides correct torque (see drawing below)

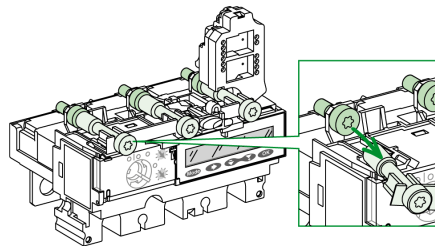

The simplicity of the replacement process means that it is easy to make the necessary adjustments as operation and maintenance processes evolve.

NOTE: The screw head is accessible when the trip unit is installed, so the trip unit can still be removed.

NOTE: On the ComPacT NSX circuit breaker with R, HB1, and HB2 breaking performances the trip units are not interchangeable.

Sealing the Protection

Seal the transparent cover on MicroLogic trip units to prevent modification of protection settings and to prevent access to the test port.

On MicroLogic 5, 6, and Vigi 7 trip units, the keypad can be used and the protection settings and measurements can be read on the screen with the cover sealed.

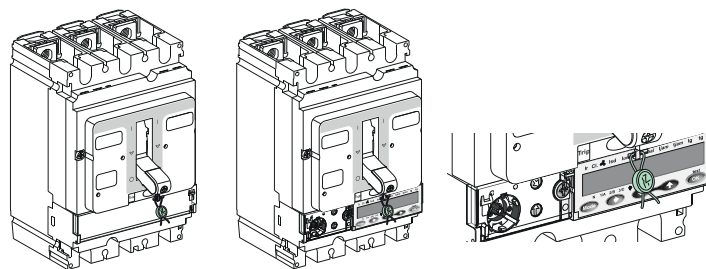

Description of the MicroLogic 5 and 6 Trip Units

Trip Unit Front Face

Use the display screen and keypad on the trip unit to set the trip unit options and check system measurements. Refer to the navigation principles for more information, page 28.

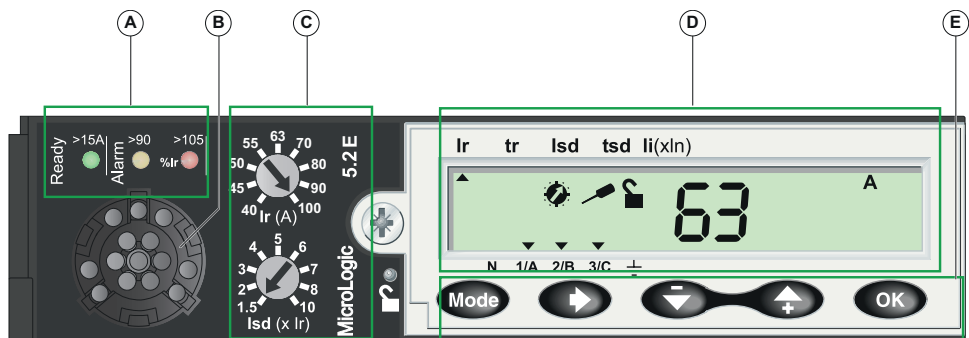

Front face of a MicroLogic 5.2 E trip unit for a 3-pole circuit breaker



- A Indication LEDs
- B Test port
- C Dials for presetting protection functions and microswitch for locking protection setting
- D LCD display
- E Navigation keypad

Indication LEDs

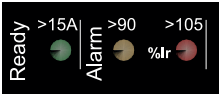
Indication LEDs show the trip unit operational state. Indication LEDs vary in meaning depending on the trip unit type.

Type of MicroLogic trip unit	Description
Distribution 	<ul style="list-style-type: none"> • Ready LED (green) blinks slowly when the standard protection functions of the electronic trip unit are operational. • Overload pre-alarm LED (orange) lights when the load exceeds 90% of the Ir setting. • Overload alarm LED (red) lights when the load exceeds 105% of the Ir setting.
Motor 	<ul style="list-style-type: none"> • Ready LED (green) blinks slowly when the standard protection functions of the electronic trip unit are operational. • Overload temperature alarm LED (red) lights when the motor thermal image exceeds 95% of the Ir setting.

Test Port

MicroLogic trip units feature a test port specifically for maintenance actions. Use the test port to:

- Connect a pocket battery for local testing of the MicroLogic trip unit

- Connect the Service Interface for testing, setting the MicroLogic trip unit, updating the MicroLogic firmware, or for installation diagnostics with EcoStruxure Power Commission software
- Connect the USB maintenance interface:
 - For push-to-trip test or installation diagnostics with the USB maintenance interface stand-alone
 - For testing and installation diagnostics, setting the MicroLogic trip unit, updating the MicroLogic firmware with the USB maintenance interface connected to a PC

For more information, refer to DOCA0187** *ComPacT NSX - Circuit Breakers and Switch-Disconnectors 100–630 A - User Guide*, page 7.

Dials and Microswitch

The trip unit face has two dials for presetting protection functions and a microswitch for locking/unlocking the protection settings done with the keypad. For distribution trip units, the dials are for setting long-time and instantaneous protection.

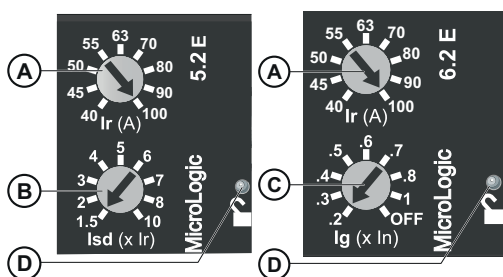

- A** Long-time protection pickup (Ir) adjustment dial
- B** Short-time protection pickup (Isd) adjustment dial (MicroLogic 5 only)
- C** Ground-fault protection pickup (Ig) adjustment dial (MicroLogic 6 only)
- D** Microswitch for locking/unlocking the protection parameter settings

LCD Display

An LCD display provides information necessary to use the trip unit. The list of protection functions varies according to the MicroLogic trip unit type.

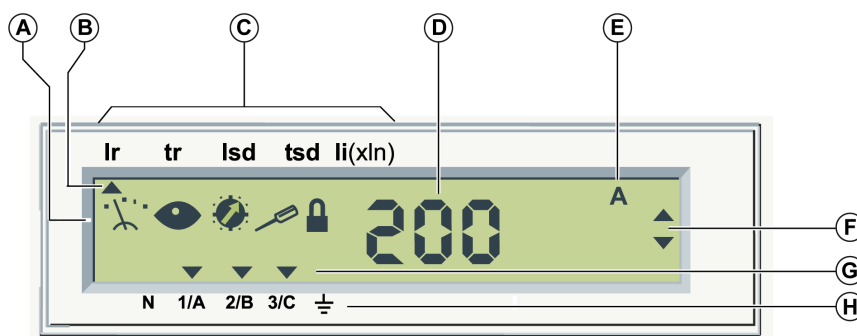

Item	Description
A	5 pictograms: : Metering : Readout : Protection : Setting : Lock The combination of pictograms defines the mode.
B	Up arrow points to protection function currently being set

Item	Description
C	<p>List of protection functions according to the MicroLogic trip unit type:</p> <ul style="list-style-type: none"> MicroLogic 5: MicroLogic 6: MicroLogic 6 E-M:
D	Value of the measured quantity
E	Unit of the measured quantity
F	Navigation arrows
G	Down arrows point to the selected phase(s), neutral, or ground
H	Phases (1/A, 2/B, 3/C), neutral (N) and ground

LCD Display Backlighting

When the MicroLogic trip unit is powered by an external 24 Vdc power supply, the trip unit display has white backlighting that is:

- Low intensity continuously
- High intensity for 1 minute after pressing one of the keys on the keypad

The display backlighting is:

- Deactivated if the temperature exceeds 65 °C (149 °F)
- Reactivated once the temperature drops back below 60 °C (140 °F)

On trip units powered by the pocket battery, the display unit is not backlit.

Navigation Keypad

Use the 5-key keypad for navigation.

Key	Description
	Selecting the mode
	Scrolling navigation
	Navigation back (metering) or - (setting the protection functions)
	Navigation forward (metering) or + (setting the protection functions)
	Confirmation

Description of the MicroLogic 7 Trip Unit with Integrated Earth-Leakage Protection

Presentation

The MicroLogic Vigi 7 electronic trip unit is available in two versions for earth-leakage detection:

- The Trip version trips when earth-leakage is detected.
- The Alarm version measures the earth-leakage current and indicates an earth-leakage fault on the display screen.

When the SDx indication contact is present, it signals an earth-leakage fault remotely.

Trip Unit Front Face

Use the display screen and keypad on the trip unit to set the trip unit options and check system measurements. Refer to the navigation principles for more information, page 28.

Front face of a MicroLogic Vigi 7 trip unit (Trip version):

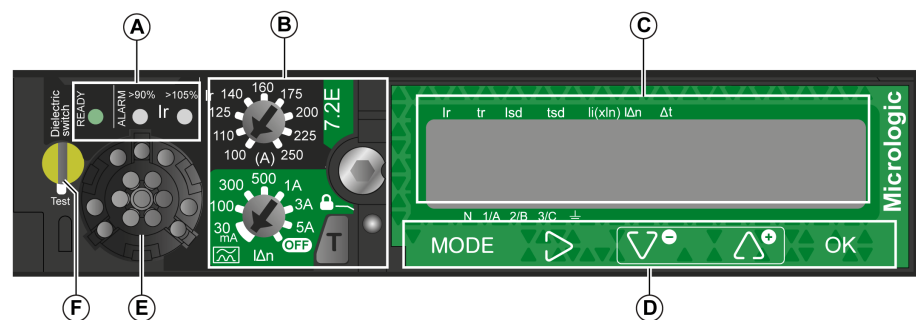

A Indication LEDs

B Adjustment dials for presetting protection functions, microswitch for locking protection setting, and test button for testing earth-leakage protection

C LCD display screen

D Navigation keypad

E Test port

F Dielectric switch

Indication LEDs

Indication LEDs show the trip unit operational state.

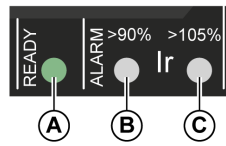

A Ready LED (green) blinks slowly when the standard protection functions of the electronic trip unit are operational.

B Overload pre-alarm LED (orange) lights when the load exceeds 90% of the Ir setting.

C Overload alarm LED (red) lights when the load exceeds 105% of the Ir setting.

Dials, Microswitch, and Test Button

The trip unit face has two adjustment dials for presetting protection functions, a microswitch for locking/unlocking the protection settings, and a test button for testing the earth-leakage protection.

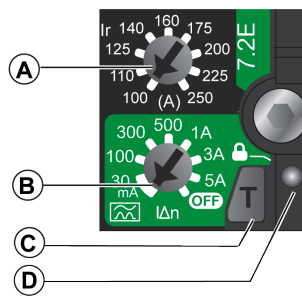

A Long-time protection pickup (Ir) adjustment dial

B Earth-leakage protection pickup (IΔn) adjustment dial

C Test button for testing earth-leakage protection

D Microswitch to lock/unlock the protection settings

LCD Display

An LCD display provides information necessary to use the trip unit. The list of protection functions varies according to the MicroLogic trip unit type.

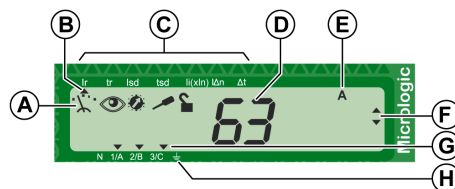

Item	Description
A	5 pictograms: : Metering : Readout : Protection : Setting : Lock The combination of pictograms defines the mode.
B	Up arrow points to protection function currently being set
C	List of protection functions for MicroLogic Vigi 7 trip unit:

Item	Description
D	Value of the measured quantity
E	Unit of the measured quantity
F	Navigation arrows
G	Down arrows point to the selected phase(s), neutral, or the ground
H	Phases (1/A , 2/B , 3/C), neutral (N) and ground

LCD Display Backlighting

When the MicroLogic trip unit is powered by an external 24 Vdc power supply, the trip unit display has white backlighting that is:

- Low intensity continuously
- High intensity for 1 minute after pressing one of the keys on the keypad





The display backlighting is:

- Deactivated if the temperature exceeds 65 °C (149 °F)
- Reactivated once the temperature drops back below 60 °C (140 °F)

On trip units powered by the pocket battery, the display unit is not backlit.

Navigation Keypad

Use the 5-key keypad for navigation.

Key	Description
	Selecting the mode
	Scrolling navigation
	Navigation back (metering) or - (setting the protection functions)
	Navigation forward (metering) or + (setting the protection functions)
	Confirmation

Test Port

MicroLogic trip units feature a test port specifically for maintenance actions.

Use the test port to:

- Connect a pocket battery for local testing of the MicroLogic trip unit
- Connect the Service Interface for testing, setting the MicroLogic trip unit, updating the MicroLogic firmware, or for installation diagnostics with EcoStruxure Power Commission software
- Connect the USB maintenance interface:
 - For push-to-trip test or installation diagnostics with the USB maintenance interface stand-alone
 - For testing and installation diagnostics, setting the MicroLogic trip unit, updating the MicroLogic firmware with the USB maintenance interface connected to a PC

For more information, refer to DOCA0187•• *ComPacT NSX - Circuit Breakers and Switch-Disconnectors 100–630 A - User Guide*, page 7.

Dielectric Switch

The dielectric switch disconnects the trip unit power supply from the phases. It is used when performing a panel dielectric test.

For more information about how to use the dielectric switch, refer to DOCA0187•• *ComPacT NSX - Circuit Breakers and Switch-Disconnectors 100–630 A - User Guide*, page 7.

Description of the BSCM Modbus SL/ULP Module

Presentation

The BSCM Modbus SL/ULP module with commercial reference LV434220 is a Breaker Status Control Module that can be used to communicate data via:

- Modbus Serial Line communication network
- ULP communication network

The following data is exchanged:

- OF and SDE circuit breaker states from the BSCM Modbus SL/ULP module
- SD circuit breaker state from SD auxiliary contact for BSCM Modbus SL/ULP module or NSX cord (if present)
- Control instructions for the communicating motor mechanism (if present): opening, closing, and resetting
- Information to assist the operator: storage of the last 10 events

When connected to a MicroLogic 5, 6 or 7 trip unit, the BSCM Modbus SL/ULP module gives access to MicroLogic data.

The BSCM Modbus SL/ULP module can be used in the following modes:

- Modbus SL only mode
- Modbus SL and ULP mode
- ULP only mode

If the BSCM Modbus SL/ULP module is used in Modbus SL only mode or in Modbus SL and ULP mode, the MicroLogic 5 or 6 trip units can be used to:

- display the BSCM Modbus SL/ULP module Modbus parameters, page 35.
- set the BSCM Modbus SL/ULP module Modbus parameters, page 40.

IMPORTANT:

- The BSCM Modbus SL/ULP module Modbus parameters can be configured on MicroLogic 5 and 6 trip units with firmware version greater than or equal to 001.008.003.
- The BSCM Modbus SL/ULP module Modbus parameters are not available on MicroLogic 7 trip units

For more information about the BSCM Modbus SL/ULP module, refer to DOCA0187** *ComPacT NSX - Circuit Breakers and Switch-Disconnectors 100–630 A - User Guide*, page 7.

Description

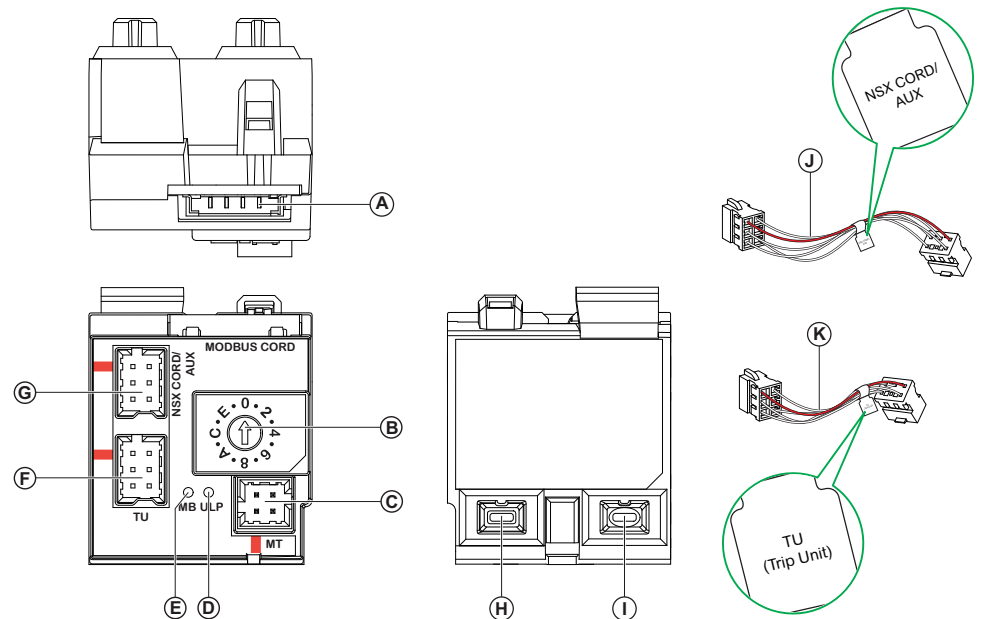

- A. Port for BSCM Modbus SL cord
- B. Modbus address selector rotary switch
- C. Port for communicating motor mechanism
- D. ULP status LED
- E. Modbus status LED
- F. Port for MicroLogic 5, 6, or 7 trip unit
- G. Port for NSX cord or SD auxiliary contact for BSCM Modbus SL/ULP module
- H. OF contact
- I. SDE contact
- J. Cable to connect the BSCM Modbus SL/ULP module to the NSX cord or SD auxiliary contact for BSCM Modbus SL/ULP module
- K. Cable to connect the BSCM Modbus SL/ULP module to a MicroLogic 5, 6, or 7 trip unit

MicroLogic Trip Unit Power Supply

Internal Power Supply for MicroLogic 5 and 6 Trip Units

The protection functions and the test functions of MicroLogic 5 and 6 trip units operate with the current through the internal current transformers (CT).

When the load current is higher than 20% of the rated current I_n , the internal current supply provides the power supply for the full functioning of the MicroLogic trip unit. This includes:

- The MicroLogic display screen and LEDs
- The maintenance and diagnostic functions

To provide a power supply to the MicroLogic 5 or 6 trip unit when the load is below 20% of the rated current I_n , and maintain the full functioning of the MicroLogic trip unit, one of the following optional power supplies can be used:

- An external 24 Vdc power supply, page 25 connected permanently to the MicroLogic trip unit
- A power supply connected temporarily to the test port on the MicroLogic trip unit:
 - Pocket battery, page 26
 - Service Interface, page 27 connected to a power supply
 - USB maintenance interface, page 27 connected to a power supply or a PC

Internal Power Supply for MicroLogic 7 Trip Units with Integrated Earth-Leakage Protection

The protection functions and the test functions of MicroLogic Vigi 7 trip units operate with the current through the internal current transformers (CT) and the internal voltage power supply.

When the load current is lower than 20% of the rated current I_n , the internal voltage power supply provides the power supply for the following minimum functions of the MicroLogic trip unit:

- The protection functions
- The indication LEDs
- The earth-leakage protection test

When the load current is higher than 20% of the rated current I_n , the internal current supply provides the power supply for the full functioning of the MicroLogic trip unit. In addition to the minimum functions, this includes the following functions:

- The MicroLogic display screen and indication LEDs
- The maintenance and diagnostic functions

To maintain the full functioning of the MicroLogic 7 trip unit when the load is lower than 20% of the rated current I_n , one of the following optional power supplies can be used:

- An external 24 Vdc power supply, page 25 connected permanently to the MicroLogic trip unit
- A power supply connected temporarily to the test port on the MicroLogic trip unit:
 - Pocket battery, page 26
 - Service Interface, page 27 connected to a power supply
 - USB maintenance interface, page 27 connected to a power supply or a PC

External 24 Vdc Power Supply

The 24 Vdc power supply maintains the operation of the functions of the MicroLogic trip unit in all circumstances, including in low load conditions (load below 20%), and when the circuit breaker is open and not energized.

The 24 Vdc power supply is essential to enable the MicroLogic trip unit to display the trip cause.



The external 24 Vdc power supply is provided to the MicroLogic trip unit once it is connected to another module in the ULP system (for example, IFM Modbus-SL interface for one circuit breaker).

When the MicroLogic trip unit is not connected to a ULP module, it can be connected directly to an external 24 Vdc power supply by using the optional 24 Vdc supply terminal block.

One 24 Vdc power supply can be used to provide power to several MicroLogic trip units or other ULP modules.

Recommended 24 Vdc Power Supplies

Available 24 Vdc power supplies include the range of Phaseo ABL8 power supplies and the AD power supplies. For more information, refer to LVPED221001EN, page 7 *ComPacT NSX & NSXm Catalogue*.

Characteristic	Phaseo ABL8 power supply	AD power supply
Illustration		
Overvoltage category defined by IEC 60947-1	Category II	<ul style="list-style-type: none"> Category IV per IEC 62477-1 (Vac model) Category III per IEC 62477-1 (Vdc model) Category III per UL 61010-1
Input supply voltage AC	<ul style="list-style-type: none"> 110–120 Vac 200–500 Vac 	<ul style="list-style-type: none"> 110–130 Vac 200–240 Vac
Input supply voltage DC	–	<ul style="list-style-type: none"> 24–30 Vdc 48–60 Vdc 100–125 Vdc
Dielectric withstand	<ul style="list-style-type: none"> Input/output: 4 kV RMS for 1 minute Input/ground: 3 kV RMS for 1 minute Output/ground: 0.5 kV RMS for 1 minute 	Input/output: <ul style="list-style-type: none"> 3 kV RMS for 1 minute (110–130 Vac and 200–240 Vac model) 3 kV RMS for 1 minute (110–125 Vdc model) 2 kV RMS for 1 minute (24–30 Vdc and 48–60 Vdc model)
Temperature	<ul style="list-style-type: none"> 50 °C (122 °F) 60 °C (140 °F) with 80% nominal load maximum 	70 °C (158 °F)
Output current	3 A, 5 A, or 10 A	1 A

Characteristic	Phaseo ABL8 power supply	AD power supply
Ripple	200 mV peak-peak	200 mV peak-peak
Output voltage setting for line loss compensation	24–28.8 Vdc	22.8–25.2 Vdc

NOTE: For applications requiring an overvoltage category higher than II, install a surge arrester when using a 24 Vdc ABL8 power supply.

ULP Module Consumption

The following table lists the ULP module consumption:

Module	Typical consumption (24 Vdc at 20 °C/68 °F)	Maximum consumption (19.2 Vdc at 60 °C/140 °F)
MicroLogic trip unit for ComPacT NSX circuit breaker	30 mA	55 mA
BSCM Modbus SL/ULP circuit breaker status control module for ComPacT NSX circuit breakers	30 mA	45 mA
BSCM circuit breaker status control module for ComPacT NSX circuit breakers	9 mA	15 mA
IFE Ethernet switchboard server	100 mA	140 mA
IFE Ethernet interface for one circuit breaker	100 mA	140 mA
IFM Modbus-SL interface for one circuit breaker	21 mA	30 mA
IO input/output application module for one circuit breaker	100 mA	130 mA
FDM121 front display module for one circuit breaker	21 mA	30 mA
Service Interface	0 mA (the Service Interface has its own power supply)	0 mA (the Service Interface has its own power supply)
USB maintenance interface	0 mA (the USB maintenance interface has its own power supply)	0 mA (the USB maintenance interface has its own power supply)
Modbus SL hub	3 mA	5 mA

For more information on power supplies, refer to DOCA0093•• *ULP System (IEC Standard) - User Guide*, page 7.

Pocket Battery

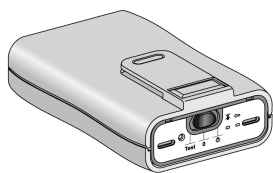

Use the pocket battery to provide a temporary power supply to the MicroLogic trip unit.

The pocket battery enables use of the MicroLogic display screen and keypad for setting and displaying when the power supply to the MicroLogic trip unit is interrupted.

The pocket battery can be connected by using the trip unit connector (supplied with the pocket battery) connected to the test port on the MicroLogic trip unit.

Check the charge level of the pocket battery by sliding the switch to the Test position. The green LED on the pocket battery lights up to indicate the battery status.

For more information on the pocket battery, refer to DOCA0187•• *ComPacT NSX - Circuit Breakers and Switch-Disconnectors 100–630 A - User Guide*, page 7.

Service Interface



Use the Service Interface to provide a temporary power supply during periods of setting, commissioning, testing, and maintenance.

The Service Interface is connected to the test port on the MicroLogic trip unit and to a PC running EcoStruxure Power Commission software.

The Service Interface must be supplied with a 24 Vdc power supply through the 24 V power adapter port. An adapter (110–230 Vac to 24 Vdc) is supplied with the Service Interface.

For more information on the Service Interface, refer to DOCA0170•• *Service Interface - User Guide*, page 7.

USB Maintenance Interface

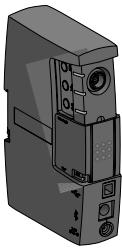

Use the USB maintenance interface to provide a temporary power supply during periods of setting, commissioning, testing, and maintenance.

The USB maintenance interface is connected to the test port on the MicroLogic trip unit.

The USB maintenance interface must be connected to the mains power supply or to a PC.



For more information on the USB maintenance interface, refer to DOCA0187•• *ComPacT NSX - Circuit Breakers and Switch-Disconnectors 100–630 A - User Guide*, page 7.

Navigation Principles

Lock/Unlock the Settings

The settings are locked when the transparent cover is closed and sealed to prevent access to the adjustment dials and the locking/unlocking microswitch.

A pictogram on the display indicates whether the settings are locked:

- Padlock locked : The settings are locked.
- Padlock unlocked : The settings are unlocked and can be changed.

To unlock the settings:

1. Open the transparent cover
2. Press the lock/unlock microswitch or turn one of the adjustment dials

To lock the settings, press the lock/unlock microswitch again.

The settings also lock automatically five minutes after pressing a key on the keypad or turning one of the dials on the MicroLogic trip unit.

Trip Unit Modes











Information displayed on the MicroLogic display is based on its mode.







The modes available depend on:





- Whether the settings are locked
- The trip unit version (3-pole or 4-pole)
- The trip unit type (MicroLogic 5, 6 or 7)

The combination of pictograms defines the mode.

The following tables show the possible modes:

Pictograms	Mode accessible with padlock locked 
 	<ul style="list-style-type: none"> • Instantaneous measurement readout • Kilowatt hour meter readout and reset
  Max Reset ? Ok	Peak demand readout and reset
 	Protection function readout
 	Neutral status readout (3-pole MicroLogic trip unit)
 	BSCM Modbus SL/ULP module setting readout (MicroLogic 5/6 trip units only)

Pictograms	Mode accessible with padlock unlocked 
 	<ul style="list-style-type: none"> • Instantaneous measurement readout • Kilowatt hour meter readout and reset
  Max Reset ? Ok	Peak demand readout and reset
 	Protection function setting

Pictograms	Mode accessible with padlock unlocked 
 	Neutral status setting (3-pole MicroLogic trip unit)
	BSCM Modbus SL/ULP module setting (MicroLogic 5/6 trip units only)

Mode Selection

Select the required mode by successive presses on the  key:

- The modes scroll cyclically.
- Press the lock/unlock microswitch to switch between readout mode and setting mode.

NOTE: For BSCM Modbus SL/ULP module Modbus settings on MicroLogic 5 and 6 trip units:

- Press the  key for five seconds.
- Press the lock/unlock microswitch to switch between readout mode and setting mode.

Screensaver

The screensaver displays the instantaneous current passing through the most heavily loaded phase (Instantaneous measurement **readout** mode).

The MicroLogic display automatically reverts to a screensaver:

- In padlock locked mode, 20 seconds after the last action on the keypad
- In padlock unlocked mode, 5 minutes after the last action on the keypad or dials

Readout Mode

Measurement Readout

MicroLogic 5 and 6 trip units and MicroLogic 7 trip units with integrated earth-leakage protection have the same five navigation keys. The appearance of the keys differs, as shown in the following table:

MicroLogic 5 and 6 trip unit	MicroLogic Vigi 7 trip unit

The following examples use the keys of the MicroLogic 5 and 6 trip units to illustrate navigation for readout and setting modes. For MicroLogic Vigi 7 trip units, navigation is made in the same way.

A measurement is read using the and keys.

- The keys are used to select the measurement to be displayed on-screen. The associated navigation arrows indicate the navigation options:



◦ : possible to press the key



◦ : possible to press the key



◦ : possible to press either of the two keys

- For the current and voltage measured quantities, the navigation key can be used to select the metering screen for each of the phases:

◦ The down arrow indicates the phase relating to the measurement value displayed.



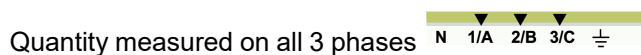
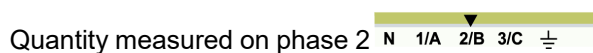





Examples:

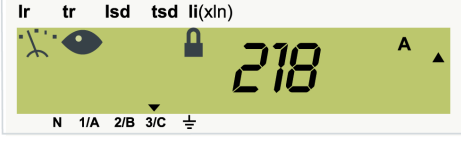

- Press the key successively to scroll through the metering screens. Scrolling is cyclical.

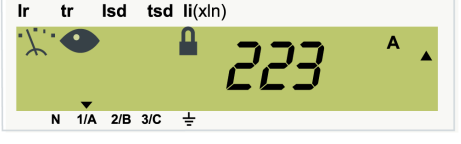
Example of Measurement Readout

The following table gives the readout values of the 3 phase currents, the phase-to-phase voltage V12, and the total active power (Ptot):

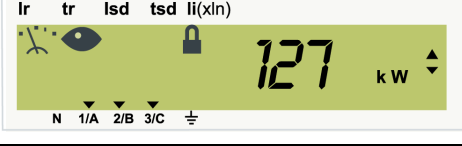
Step	Action	Using	Display
1	Select the Instantaneous measurement readout mode (the most heavily loaded phase is displayed). Read the value of current I2.		
2	Select the next current measurement: current I3. Read the value of current I3.		
3	Select the next current measurement: current I1. Read the value of current I1.		
4	Select the phase-to-phase voltage V12 measurement. Read the value of voltage V12.		
5	Select the Ptot power measurement. Read the Ptot active power.		

Energy Meter Readout

Energy meters change measurement unit automatically:







- For active energy, Ep, displayed in kWh from 0 to 9999 kWh then in MWh
- For reactive energy, Eq, displayed in kVARh from 0 to 9999 kVARh then in MVARh
- For apparent energy, Es, displayed in kVAh from 0 to 9999 kVAh then in MVAh

When energies are indicated in MWh, MkVARh, or MVAh, the values display on 4 digits. The MicroLogic trip unit incorporates the option of full energy meter readout.

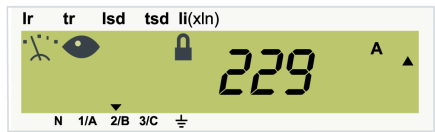

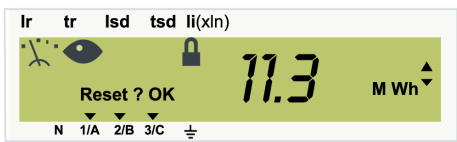
NOTE: The energy meter can be reset with the padlock locked or unlocked.

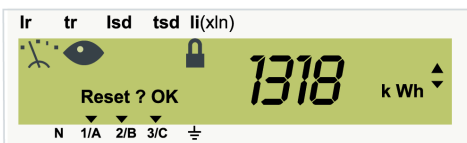

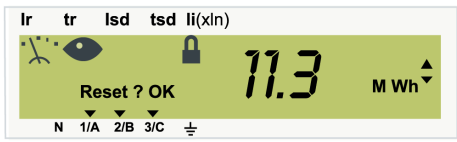



Reading Full Energy Values

The following table gives the full readout values of the Ep active energy meter.

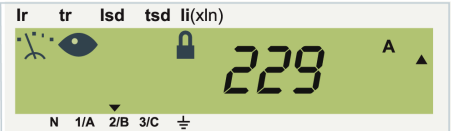
Step	Readout value	Action	Using	Display
1	Current in most heavily loaded phase	Select the Readout and reset the energy meter mode (main screen displayed).		
2	Energy with Reset option showing	Select the Ep active energy meter. The value displayed is 11.3 MWh (in the example), which corresponds to 10 MWh +1300 kWh (approximately).		
3	Specific energy measurement	Specify the measurement. The value displayed is 1318 kWh (in the example): the full energy meter value is 11318 kWh.		
4	Energy normal display	Return to the energy meter normal display. The display reverts automatically after 5 minutes.		



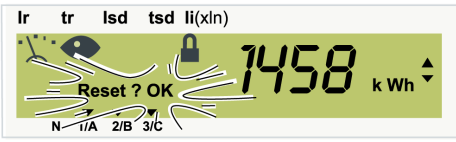

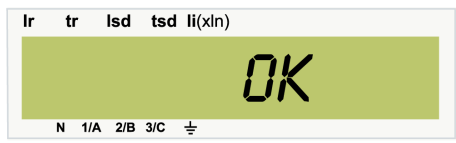

Resetting Energy Meter

The energy meters can be reset with the padlock locked  or unlocked .

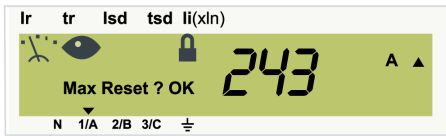
Step	Readout value	Action	Using	Display
1	Current in most heavily loaded phase	Select the Measurement readout and reset energy meter mode (main screen displayed).		
2	Energy with Reset option showing	Select the energy meter to be reset.		
3	Reset option lit	Validate the reset. The OK pictogram blinks.		
4	OK	Confirm the reset. The confirmation OK is displayed for 2 s.		

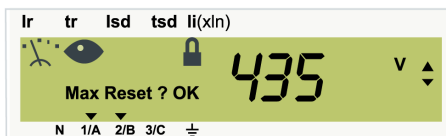
Resetting Peak Demand Values

The peak demand values can be reset with the padlock locked  or unlocked .

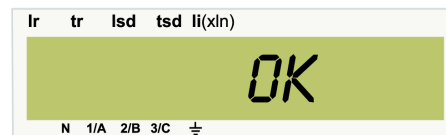
Step	Readout value	Action	Using	Display
1	Main screen	Select the Readout and reset peak demand values mode (main screen displayed).		
2	Peak demand with Reset option showing	Select the peak demand to be reset.		
3	Reset option lit	Validate the reset. The OK pictogram blinks.		
4	OK	Confirm the reset. The confirmation OK is displayed for 2 s.		

Protection Function Readout

A protection function is selected using the  key. This selection is only possible in **Readout** mode, that is, when the padlock is locked.





- Scrolling is cyclical.
- The up arrow indicates the selected protection function.

For the neutral protection functions, the down arrow, pointing to **N**, replaces the up arrow.

Example: Ir pickup selected 

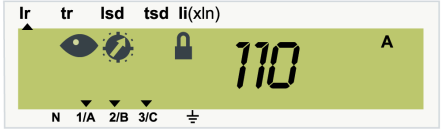

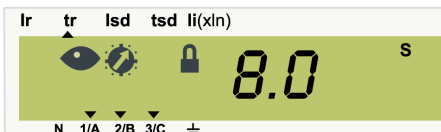
Example of Protection Function Readout

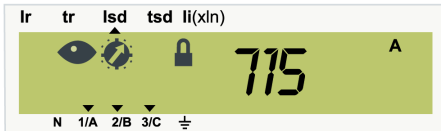
Readout of the setting values for the long-time protection Ir pickup, tr time delay, and the short-time protection Isd pickup:

Step	Readout value	Action	Using	Display
1	Long-time protection Ir pickup setting value in amperes	Select the Protection function readout mode (main screen displayed). The long-time protection Ir pickup setting value is displayed in amps.		
2	Long-time protection tr time delay setting value in seconds	Select the long-time protection tr time delay. The long-time protection tr time delay setting value is displayed in seconds.		
3	Short-time protection Isd pickup setting value in amperes	Select the short-time protection Isd pickup The short-time protection Isd pickup setting value is displayed in amps.		

Neutral Status Readout (3-Pole Trip Unit)

The Neutral status **readout** mode is dedicated to this function. Navigation is therefore limited to the  key.

Step	Readout value	Action	Using	Display
1	Neutral status is displayed	Select the Neutral status readout mode. The neutral status value is displayed: <ul style="list-style-type: none"> N: Neutral protection active (3-pole trip unit with ENCT option declared) noN: Neutral protection not active (3-pole trip unit without ENCT option or with ENCT option not declared) 		

BSCM Modbus SL/ULP Module Settings Readout (MicroLogic 5/6 Trip Units Only)

Only for MicroLogic 5 and 6 trip units, BSCM Modbus SL/ULP module settings are read by pressing the  key for five seconds.

It is not necessary to unlock the settings with the lock/unlock microswitch to read the BSCM Modbus SL/ULP module settings.

Press the  key successively to scroll through the setting screens.

Scrolling is cyclical.

The following BSCM Modbus SL/ULP settings can be read:

- The Modbus address
- The Baud rate
- The parity

Setting of the MicroLogic Protection Functions

⚠ WARNING

HAZARD OF NUISANCE TRIPPING OR FAILURE TO TRIP

Protection setting adjustments must be done by qualified electrical personnel.

Failure to follow these instructions can result in death, serious injury, or equipment damage.

Setting a Protection Function Using a Dial

Use an adjustment dial to set the following protection functions:

- The I_r and I_{sd} pickups for MicroLogic 5 trip unit
- The I_r and I_g pickups for MicroLogic 6 trip unit
- The I_r and $I_{\Delta n}$ pickups for MicroLogic 7 trip unit with integrated earth-leakage protection

Turning a dial results simultaneously in:



- Selection of the screen for the protection function assigned to the dial
- Unlocking (if necessary) the padlock (the navigation interface is in protection function setting mode)
- Setting the protection function assigned to the dial to the value indicated on the dial and on-screen.

Setting a Protection Function on the Keypad

Use the keypad to fine-tune the protection function:

- The setting value cannot exceed that indicated by the dial.
- All the protection function settings are accessible on the keypad.







Press the **Mode** key successively to scroll through the protection function screens. Scrolling is cyclical.

Navigate through the protection function settings with the  and  navigation keys.

- Use the  key to select the function to set:
 - The up arrow indicates the selected function.
 - The down arrow indicates phase. Multiple down arrows indicate all phases set to the same value (except for the neutral protection setting).
 - Scrolling is cyclical.



- Set the protection functions on the keypad with the  keys.

The associated navigation arrows indicate the setting options:

-  : possible to press the  key (increases the setting value)
-  : possible to press the  key (decreases the setting value)
-  : possible to press one of the two  keys

Confirmation of Setting

The value of a protection function set on the keypad must be:



- validated by pressing the  key once (the **OK** pictogram blinks on the display)
- then confirmed by pressing the  key again (the text **OK** is displayed for 2 s).





NOTE: Setting using a dial does not require any validation/confirmation action.

Example of Presetting a Protection Function Using a Dial

The following table illustrates presetting and setting the long-time protection I_r pickup on a MicroLogic 5.2 trip unit rated 100 A.

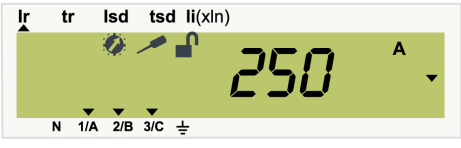
Press the  key to scroll through the metering screens.

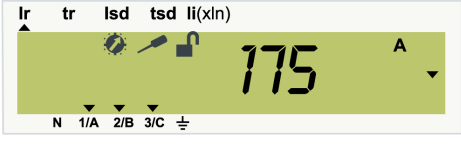
Press the ,  and  navigation keys to select the metering screen for each of the phases.

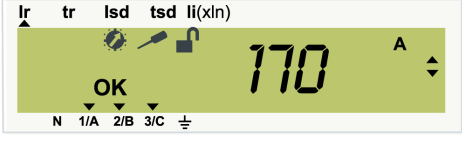
Step	Action	Using	Display
1	Set the I _r dial to the maximum value (the padlock unlocks automatically). The down arrows indicate all three phases (the setting is identical on each phase).		
2	Turn the I _r dial to the setting above the value required.		
3	Presetting is complete: <ul style="list-style-type: none"> If the pickup setting value is correct (in this case, 175 A), exit the setting procedure (no validation is required). The long-time protection I_r pickup is set at 175 A. If the pickup setting value is not suitable, fine-tune it on the keypad. 		
4	Set the exact value required for I _r on the keypad (in increments of 1 A).		

Step	Action	Using	Display
5	Validate the setting (the OK pictogram blinks).		
6	Confirm the setting. The confirmation OK is displayed for 2 s.		

Example of Setting a Protection Function on the Keypad

The following table illustrates setting the long-time protection tr time delay on a MicroLogic 5.2 trip unit.

Press the key to scroll through the screens.

Press the , , and navigation keys to select the screen for each of the phases.



Step	Action	Using	Display
1	If the pictogram is displayed, unlock the protection settings.		
2	Select the Protection function setting mode.		
3	Select the tr function: the up arrow moves under tr.		
4	Set the tr value required on the keypad.		
5	Validate the setting (the OK pictogram blinks).		
6	Confirm the setting. The confirmation OK is displayed for 2 s.		

Verification of the Protection Function Setting

In Protection function **setting** mode, a setting can be a relative value.





In Protection function **readout** mode, the setting is an actual value (for example in amps).

For example, to determine the actual value of a function currently being set as a relative value before validating the setting:

1. Press the lock/unlock microswitch  once (the display switches to **Readout** mode on the function currently being set and indicates the actual setting value).
2. Press the  microswitch again (the display reverts to **Setting** mode on the function currently being set).

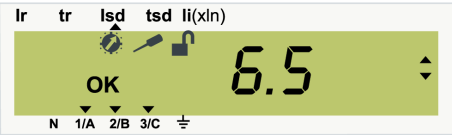
Example of Verification of a Protection Function Setting

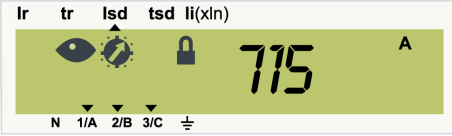
The following table illustrates as an example the verification of the setting for the short-time protection Isd pickup on a MicroLogic 5.2 trip unit currently being set:

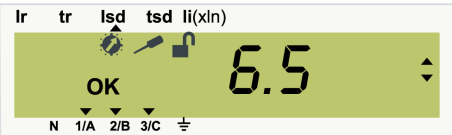
Step	Action	Using	Display
1	The display is in Setting mode on the Isd function: <ul style="list-style-type: none"> • The  pictogram is displayed. • The Isd pickup setting is in multiples of Ir. 	—	
2	Lock the setting: <ul style="list-style-type: none"> • The display switches to Setting readout mode on the Isd function (the  pictogram is displayed). • The Isd pickup setting is a value (715 A in the example). 		
3	Unlock the setting: <ul style="list-style-type: none"> • The display reverts to Setting mode on the Isd function. • The  pictogram is displayed. 		

Setting of the BSCM Modbus SL/ULP Module (Micrologic 5/6 Trip Units Only)

⚠ WARNING

HAZARD OF NUISANCE TRIPPING OR FAILURE TO TRIP

Setting adjustments of the BSCM Modbus SL/ULP module must be done by qualified electrical personnel.

Failure to follow these instructions can result in death, serious injury, or equipment damage.

BSCM Modbus SL/ULP Module Modbus Parameters

The following Modbus parameters can be configured on MicroLogic 5 and 6 trip units when the BSCM Modbus SL/ULP module is in Modbus SL only mode or Modbus SL and ULP mode:

- The Modbus address
- The Baud rate and the Modbus SL Auto Go function
- The parity

IMPORTANT:

- The BSCM Modbus SL/ULP module Modbus parameters can be configured on MicroLogic 5 and 6 trip units with firmware version greater than or equal to 001.008.003.
- The BSCM Modbus SL/ULP module Modbus parameters are not available on MicroLogic 7 trip units

If the position of the Modbus address rotary switch is on 0, it is possible to read and change the BSCM Modbus SL/ULP module Modbus address on the display of the MicroLogic 5 and 6 trip unit.

If the position of the Modbus address rotary switch is on 1 to D, the BSCM Modbus SL/ULP module Modbus address is set to 1 to 13 respectively. It is possible to read, but not change the BSCM Modbus SL/ULP module Modbus address on the display of the MicroLogic 5 and 6 trip units.







For Modbus address rotary switch positions 0 to D, it is possible to read and change the Baud rate and parity by using the MicroLogic 5 or 6 trip unit.

NOTE: Modbus address rotary switch positions E and F are not operational, and are reserved for future use.

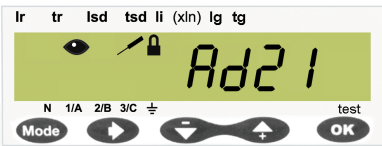
The BSCM Modbus SL/ULP module Modbus parameters can be set also with EcoStruxure Power Commission software (password-protected).

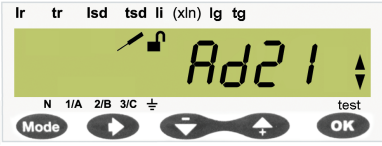

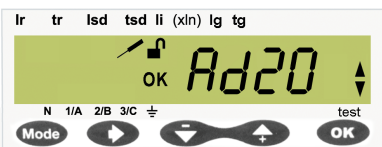
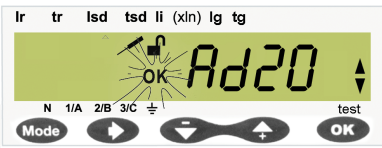
Setting the BSCM Modbus SL/ULP Module Modbus Address







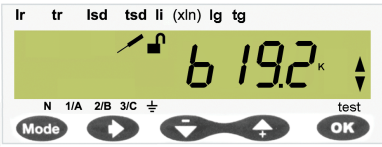

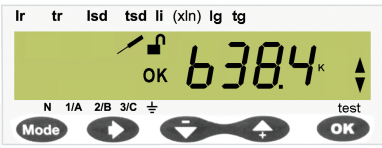

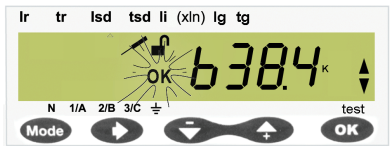

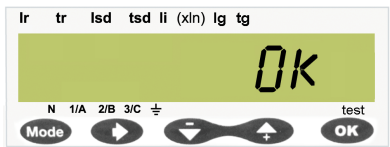
The following table illustrates setting the BSCM Modbus SL/ULP module Modbus address on a MicroLogic 5 or 6 trip unit:

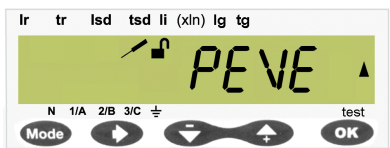
Step	Action	Using	Display
1	Press the Mode key for five seconds. The BSCM Modbus SL/ULP module Modbus address is displayed.	Mode	
2	Press the lock/unlock microswitch.		
3	Set the BSCM Modbus SL/ULP module Modbus address on the keypad.		
4	Validate the BSCM Modbus SL/ULP module Modbus address (the OK pictogram blinks).	OK	
5	Confirm the BSCM Modbus SL/ULP module Modbus address. The confirmation OK is displayed for 2 s.	OK	

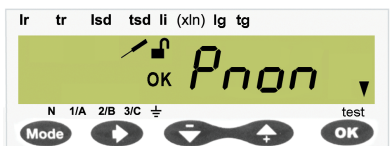

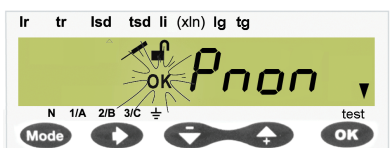

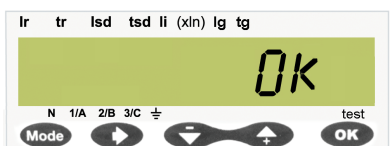

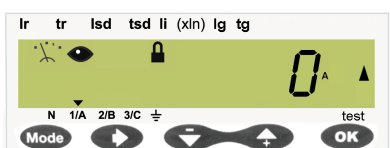

Setting the BSCM Modbus SL/ULP Module Modbus Parameters

The following table illustrates setting the BSCM Modbus SL/ULP module Modbus parameters on a MicroLogic 5 or 6 trip unit:

Step	Action	Using	Display
1	After setting the Modbus address, press the navigation key. The Baud rate is displayed.		
2	Select the Baud rate on the keypad: <ul style="list-style-type: none"> 4.8 kBd 9.6 kBd 19.2 kBd 38.4 kBd Auto NOTE: Select Auto to enable the Modbus SL Auto Go function.		



Step	Action	Using	Display
3	Validate the Baud rate (the OK pictogram blinks).		
4	Confirm the Baud rate. The confirmation OK is displayed for 2 s.		
5	Press the navigation key. The parity is displayed.		
6	Select the parity on the keypad: <ul style="list-style-type: none"> • Even • Odd • None 		
7	Validate the parity (the OK pictogram blinks).		
8	Confirm the parity. The confirmation OK is displayed for 2 s.		
9	Exit the setting mode The screen with I1/A current value is displayed.		

Metering Screens

Mode	Screen description	Unit	Arrows
 	Readout as instantaneous rms value of the: <ul style="list-style-type: none"> 3 phase currents I1/A, I2/B, and I3/C 	A	The down arrow indicates the conductor (phase, neutral, or ground) corresponding to the value shown.
	<ul style="list-style-type: none"> Ground-fault current (MicroLogic 6) 	% Ig	
	<ul style="list-style-type: none"> Earth-leakage current (MicroLogic 7) 	A	
	<ul style="list-style-type: none"> Neutral current IN (4-pole or 3-pole with ENCT option) 	A	
	Readout as instantaneous rms value of the: <ul style="list-style-type: none"> Phase-to-phase voltages V12, V23, and V31 Phase-to-neutral voltages V1N, V2N, and V3N (4-pole or 3-pole with ENVV option) 	V	The down arrows indicate the conductors (phases or neutral) corresponding to the value shown.
	Readout of the total active power Ptot	kW	The down arrows indicate the 3 phase conductors.
	Readout of the total apparent power Stot	kVA	
Readout of the total reactive power Qtot	kVAR		
  Reset ? Ok	Readout and resetting of the active energy meter Ep	kWh, MWh	
	Readout and resetting of the apparent energy meter Es	kVAh, MVAh	
	Readout and resetting of the reactive energy meter Eq	kVARh, MVARh	
 	Readout of the phase rotation	—	
  Max Reset ? Ok	Readout and resetting of the: <ul style="list-style-type: none"> Maximum Ii MAX for the 3 phase currents 	A	The down arrow indicates the conductor (phase, neutral, or ground) on which the maximum was measured.
	<ul style="list-style-type: none"> Maximum ground-fault current (MicroLogic 6) 	% Ig	
	<ul style="list-style-type: none"> Maximum earth-leakage current (MicroLogic 7) 	A	
	<ul style="list-style-type: none"> Maximum IN MAX for the neutral current (4-pole or 3-pole with ENCT option) 	A	
	Readout and resetting of the: <ul style="list-style-type: none"> Maximum Vij MAX for the 3 phase-to-phase voltages Maximum ViN MAX for the 3 phase-to-neutral voltages (4-pole or 3-pole with ENVV option) 	V	The down arrows indicate the phases between which the maximum V MAX L-L or L-N was measured.
	Readout and resetting of the maximum P MAX of the active power	kW	The down arrows indicate the 3 phase conductors.
	Readout and resetting of the maximum S MAX of the apparent power	kVA	
	Readout and resetting of the maximum Q MAX of the reactive power	kVAR	



Protection Function Screens

MicroLogic 5 LSI: Protection Function Readout Screens







Mode	Screen description	Unit	Arrows
	Ir: Long-time protection pickup value setting for the phases	A	The up arrow indicates the Ir function. The down arrows indicate the 3 phases.
	Ir(IN): Long-time protection pickup value setting for the neutral (4-pole or 3-pole trip unit with ENCT option and neutral protection active)	A	The up arrow indicates the Ir function. The down arrow indicates the neutral.
	tr: Long-time protection time delay value (at 6 Ir)	s	The up arrow indicates the tr function.
	Isd: Short-time protection pickup value setting for the phases	A	The up arrow indicates the Isd function. The down arrows indicate the 3 phases.
	Isd(IN): Short-time protection pickup value for the neutral (4-pole or 3-pole trip unit with ENCT option and neutral protection active)	A	The up arrow indicates the Isd function. The down arrow indicates the neutral.
	tsd: Short-time protection time delay value The time delay is associated with the I ² t inverse time curve protection function: <ul style="list-style-type: none"> ON: I²t function active OFF: I²t function not active 	s	The up arrow indicates the tsd function.
li: Instantaneous protection pickup value setting for the phases and for the neutral (4-pole or 3-pole trip unit with ENCT option and neutral protection active)	A	The up arrow indicates the li function. The down arrows indicate the 3 phases.	
	Neutral status (3-pole trip unit with ENCT option): <ul style="list-style-type: none"> N: Neutral protection active noN: Neutral protection not active 	–	–

MicroLogic 5 LSI: Protection Function Setting Screens

Mode	Screen description	Unit	Arrows
	Ir: Long-time protection pickup setting for the phases Preset by a dial	A	The up arrow indicates the Ir function. The down arrows indicate the 3 phases.
	tr: Long-time protection time delay setting	s	The up arrow indicates the tr function.
	Isd: Short-time protection pickup setting for the phases Preset by a dial	Isd/Ir	The up arrow indicates the Isd function. The down arrows indicate the 3 phases.
	tsd: Short-time protection time delay setting Activation of the I ² t inverse time curve short-time protection <ul style="list-style-type: none"> ON: I²t function active OFF: I²t function time curve not active 	s	The up arrow indicates the tsd function.
	IN: Protection pickup setting for the neutral (4-pole or 3-pole trip unit with ENCT option and neutral protection active)	IN/Ir	The down arrow indicates the neutral.

Mode	Screen description	Unit	Arrows
	li: Instantaneous protection pickup value setting for the phases and for the neutral (4-pole or 3-pole trip unit with ENCT option and active neutral protection)	li/In	The up arrow indicates the li function. The down arrows indicate the 3 phases.
  	Activation of neutral status (3-pole trip unit with ENCT option) <ul style="list-style-type: none"> • N: Neutral protection active • noN: Neutral protection not active 	–	–

MicroLogic 6 LSIG: Protection Function Readout Screens

Mode	Screen description	Unit	Arrows
  	lr: Long-time protection pickup value for the phases	A	The up arrow indicates the lr function. The down arrows indicate the 3 phases.
  	lr(IN): Long-time protection pickup value for the neutral (4-pole or 3-pole trip unit with ENCT option and neutral protection active)	A	The up arrow indicates the lr function. The down arrow indicates the neutral.
	tr: Long-time protection time delay value (at 6 lr)	s	The up arrow indicates the tr function.
	lsd: Short-time protection pickup value for the phases	A	The up arrow indicates the lsd function. The down arrows indicate the 3 phases.
	lsd(IN): Short-time protection pickup value for the neutral (4-pole or 3-pole trip unit with ENCT option and neutral protection active)	A	The up arrow indicates the lsd function. The down arrow indicates the neutral.
	tsd: Short-time protection time delay value The time delay is associated with the I ² t inverse time curve protection function: <ul style="list-style-type: none"> • ON: I²t function active • OFF: I²t function not active 	s	The up arrow indicates the tsd function.
	li: Instantaneous protection pickup value setting for the phases and the neutral (4-pole or 3-pole trip unit with ENCT option and neutral protection active)	A	The up arrow indicates the li function. The down arrows indicate the 3 phases.
	lg: Ground-fault protection pickup value	A	The up arrow indicates the lg function. The down arrows indicate the 3 phases.
	tg: Ground-fault protection time delay value The time delay is associated with the I ² t inverse time curve protection function: <ul style="list-style-type: none"> • ON: I²t function active • OFF: I²t function not active 	s	The up arrow indicates the tg function.
	Neutral status (3-pole trip unit with ENCT option): <ul style="list-style-type: none"> • N: Neutral protection active • noN: Neutral protection not active 	–	–

MicroLogic 6 LSIG: Protection Function Setting Screens

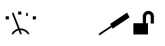
Mode	Screen description	Unit	Arrows
	lr: Long-time protection pickup setting for the phases Preset by a dial	A	The up arrow indicates the lr function. The down arrows indicate the 3 phases.
	tr: Long-time protection time delay setting	s	The up arrow indicates the tr function.
	lsd: Short-time protection pickup setting for the phases	lsd/lr	The up arrow indicates the lsd function. The down arrows indicate the 3 phases.
	tsd: Short-time protection time delay setting Activation of the I ² t inverse time curve short-time protection <ul style="list-style-type: none"> ON: I²t function active OFF: I²t function not active 	s	The up arrow indicates the tsd function.
	ln: Protection pickup setting for the neutral (4-pole or 3-pole trip unit with ENCT option and neutral protection active)	ln/lr	The down arrow indicates the neutral.
	li: Instantaneous protection pickup value for the phases and for the neutral (4-pole or 3-pole trip unit with ENCT option and neutral protection active)	li/ln	The up arrow indicates the li function. The down arrows indicate the 3 phases.
	lg: Ground-fault protection pickup setting Preset by a dial	lg/ln	The up arrow indicates the lg function. The down arrows indicate the 3 phases.
	tg: Ground-fault protection time delay setting Activation of the I ² t inverse time curve ground-fault protection <ul style="list-style-type: none"> ON: I²t function active OFF: I²t function not active 	s	The up arrow indicates the tg function.
 Activation of neutral status (3-pole trip unit with ENCT option) <ul style="list-style-type: none"> N: Neutral protection active noN: Neutral protection not active 	–	–	

MicroLogic 6 E-M LSIG: Protection Function Readout Screens



Mode	Screen description	Unit	Arrows
	lr: Long-time protection pickup value for the phases	A	The up arrow indicates the lr function. The down arrows indicate the 3 phases.
	Cl: Long-time protection trip class (value at 7.2 lr)	s	The up arrow indicates the Cl function.
	Y: Type of ventilation <ul style="list-style-type: none"> Auto: Natural ventilation by the motor Moto: Forced ventilation by a dedicated motor 	–	The up arrow indicates the Y function.
	lsd: Short-time protection pickup value for the phases	A	The up arrow indicates the lsd function. The down arrows indicate the 3 phases.
	lnbal: Phase unbalance protection pickup value (expressed as a percentage of the average motor current)	%	The up arrow indicates the lnbal function. The down arrows indicate the 3 phases.

Mode	Screen description	Unit	Arrows
	tunbal: Phase unbalance protection time delay value	s	The up arrow indicates the tunbal function.
	ljam: Jam motor protection pickup value (if OFF is indicated, jam motor protection is not active)	A	The up arrow indicates the ljam function. The down arrows indicate the 3 phases.
	tjam: Jam motor protection time delay value	s	The up arrow indicates the tjam function.
	lg: Ground-fault protection pickup value	A	The up arrow indicates the lg function. The down arrows indicate the 3 phases.
	tg: Ground-fault protection time delay value OFF is always indicated: the I ² t inverse time curve protection function is not available on MicroLogic 6 E-M trip units.	s	The up arrow indicates the tg function.

MicroLogic 6 E-M L SIG: Protection Function Setting Screens

Mode	Screen description	Unit	Arrows
	lr: Long-time protection pickup setting for the 3 phases Preset by a dial	A	The up arrow indicates the lr function. The down arrows indicate the 3 phases.
	Cl: Selection of the long-time protection trip class	s	The up arrow indicates the Cl function.
	Y: Choice of type of ventilation <ul style="list-style-type: none"> • Auto: Natural ventilation by the motor active • Moto: Forced ventilation by a dedicated motor active 	–	The up arrow indicates the Y function.
	lsd: Short-time protection pickup setting for the 3 phases	lsd/lr	The up arrow indicates the lsd function. The down arrows indicate the 3 phases.
	lunbal: Phase unbalance protection pickup setting (expressed as a percentage of the average motor current)	%	The up arrow indicates the lunbal function. The down arrows indicate the 3 phases.
	tunbal: Phase unbalance protection time delay setting	s	The up arrow indicates the tunbal function.
	ljam: Jam motor protection pickup setting (if OFF is indicated, jam motor protection is not active)	ljam/lr	The up arrow indicates the ljam function. The down arrows indicate the 3 phases.
	tjam: Jam motor protection time delay setting	s	The up arrow indicates the tjam function.
	lg: Ground-fault protection pickup setting Preset by a dial	lg/lr	The up arrow indicates the lg function.
	tg: Ground-fault protection time delay setting	s	The up arrow indicates the tg function. The down arrows indicate the 3 phases.

MicroLogic 7 LSIV: Protection Function Readout Screens

Mode	Screen description	Unit	Arrows
	I _r : Long-time protection pickup value for the phases	A	The up arrow indicates the I _r function. The down arrows indicate the 3 phases.
	I _r (IN): Long-time protection pickup value for the neutral (4-pole and neutral protection active)	A	The up arrow indicates the I _r function. The down arrow indicates the neutral.
	t _r : Long-time protection time delay value (at 6 I _r)	s	The up arrow indicates the t _r function.
	I _{sd} : Short-time protection pickup value for the phases	A	The up arrow indicates the I _{sd} function. The down arrows indicate the 3 phases.
	I _{sd} (IN): Short-time protection pickup value for the neutral (4-pole and neutral protection active)	A	The up arrow indicates the I _{sd} function. The down arrow indicates the neutral.
	t _{sd} : Short-time protection time delay value The time delay is associated with the I ² t inverse time curve protection function: <ul style="list-style-type: none"> ON: I²t function active OFF: I²t function not active 	s	The up arrow indicates the t _{sd} function.
	I _i : Instantaneous protection pickup value setting for the phases and the neutral (4-pole and neutral protection active)	A	The up arrow indicates the I _i function. The down arrows indicate the 3 phases.
	IΔn: Earth-leakage protection pickup value	A	The up arrow indicates the IΔn function. The down arrows indicate the 3 phases.
	Δt: Earth-leakage protection time delay value	s	The up arrow indicates the Δt function.
	Neutral status: <ul style="list-style-type: none"> N: Neutral protection active noN: Neutral protection not active 	–	–

MicroLogic 7 LSIV: Protection Function Setting Screens

Mode	Screen description	Unit	Arrows
	I _r : Long-time protection pickup setting for the phases Preset by a dial	A	The up arrow indicates the I _r function. The down arrows indicate the 3 phases.
	t _r : Long-time protection time delay setting	s	The up arrow indicates the t _r function.
	I _{sd} : Short-time protection pickup setting for the phases	I _{sd} /I _r	The up arrow indicates the I _{sd} function. The down arrows indicate the 3 phases.
	t _{sd} : Short-time protection time delay setting Activation of the I ² t inverse time curve short-time protection <ul style="list-style-type: none"> ON: I²t function active OFF: I²t function not active 	s	The up arrow indicates the t _{sd} function.
	IN: Protection pickup setting for the neutral (4-pole and neutral protection active)	IN/I _r	The down arrow indicates the neutral.

Mode	Screen description	Unit	Arrows
	li: Instantaneous protection pickup value for the phases and for the neutral (4-pole and neutral protection active)	li/ln	The up arrow indicates the li function. The down arrows indicate the 3 phases.
	IΔn: Earth-leakage protection pickup setting Preset by a dial NOTE: The present and previous earth-leakage protection settings are recorded in a history, page 169	A	The up arrow indicates the IΔn function. The down arrows indicate the 3 phases.
	Δt: Earth-leakage protection time delay setting	s	The up arrow indicates the Δt function.
	Activation of neutral status <ul style="list-style-type: none"> • N: Neutral protection active • noN: Neutral protection not active 	–	–

EcoStruxure Power Commission Software

Overview

EcoStruxure Power Commission software automatically discovers the smart devices and allows you to add the devices for an easy configuration. You can generate comprehensive reports as part of Factory Acceptance Test and Site Acceptance Test to replace your heavy manual work. Additionally, when the panels are under operation, any change of settings made can be easily identified by a yellow highlighter. This indicates the difference between the project and device values, and hence provides a system consistency during the operation and maintenance phase.

EcoStruxure Power Commission software enables the configuration of ComPacT NSX circuit breakers with the following modules, and accessories:

- MicroLogic trip units
- Communication interface modules:
 - BSCM Modbus SL/ULP module
 - IFM communication interface
 - IFE communication interface
- ULP modules:
 - IO module
 - FDM121 display

EcoStruxure Power Commission software enables the configuration of the following gateways and wireless devices:

- EcoStruxure Panel Server
- PowerTag Link gateway
- PowerTag Energy module
- Wireless indication auxiliary

Click [here](#) to download the latest version of EcoStruxure Power Commission software.

Key Features

EcoStruxure Power Commission software performs the following actions for the supported devices and modules:

- Create projects by device discovery
- Save the project in the EcoStruxure Power Commission cloud for reference
- Upload settings to the device and download settings from the device
- Compare the settings between the project and the device
- Perform control actions in a secured way
- Generate and print the device settings report
- Perform a communication wiring test on the entire project and generate and print test report
- View the communication architecture between the devices in a graphical representation
- View the measurements, logs, and maintenance information
- View the status of device and IO module
- View the alarm details
- Check the system firmware compatibility status

- Update to the latest device firmware
- Perform force trip and automatic trip curve test

Password Management

General Description

Remote access to data on MicroLogic trip units and the ULP modules of the IMU is protected by password. Remote access includes:

- The communication network
- EcoStruxure Power Commission software
- FDM128 display
- IFE webpages

The following four profiles are defined for remote access. Each IMU has a different password for each user profile:

- Administrator
- Services
- Engineer
- Operator

The Administrator password is required for the following tasks:

- Writing the settings to the MicroLogic trip unit and the ULP modules of the IMU using the EcoStruxure Power Commission Software, page 50
- Updating the firmware, page 54

Each intrusive command via the command interface is assigned to one or several user profiles, and protected by the corresponding user profile password. The password for each intrusive command is indicated in the description of the command.

No password is required for non-intrusive commands through the command interface.

Default Passwords

⚠ WARNING

POTENTIAL COMPROMISE OF SYSTEM AVAILABILITY, INTEGRITY, AND CONFIDENTIALITY

Change default passwords at first use to help prevent unauthorized access to device settings, controls, and information.

Failure to follow these instructions can result in death, serious injury, or equipment damage.

The default password for each user profile is as follows:

User profile	Default password
Administrator	'0000' = 0x30303030
Services	'1111' = 0x31313131
Engineer	'2222' = 0x32323232
Operator	'3333' = 0x33333333

Changing a Password

A password can be changed with the EcoStruxure Power Commission software, page 50.

Entering the current password for a given user profile is required to change the password of this user profile. Entering the Administrator password enables you to change the password of any user profile.

A password is composed of exactly 4 ASCII characters. It is case-sensitive and the allowed characters are:

- Digits from 0 to 9
- Letters from a to z
- Letters from A to Z

Passwords of the IMU

The MicroLogic trip unit and the ULP modules of the IMU must be protected by the same passwords for each user profile.

When using EcoStruxure Power Commission software to modify a password, the password gets modified in the MicroLogic trip unit and the ULP modules of the IMU.

It is compulsory to assign the current IMU passwords to the new module in the IMU, in case of:

- addition of a new ULP module in the IMU.
- replacement of the MicroLogic trip unit or one of the ULP module of the IMU.

Use EcoStruxure Power Commission software to modify the passwords of the new module to the current IMU passwords.

Example: Addition of an IO module in an IMU with a MicroLogic trip unit and an IFE interface.

- The IMU has user-defined passwords for each user profile.
- The IO module has the default passwords for each user profile.

Use EcoStruxure Power Commission software to replace the default passwords of the IO module by the user-defined passwords of the IMU for each user profile.

Password Reset

In case that the Administrator password of the (IMU) is lost or forgotten, the password can be reset to the default password with EcoStruxure Power Commission software, page 50 and the support of the Schneider Electric Customer Care Center.

Firmware Update

Introduction

The primary reason for updating the firmware of a MicroLogic trip unit is to obtain the latest MicroLogic features. If the latest MicroLogic features are not required, it is not mandatory to update the firmware of the MicroLogic trip unit and the Enerlin'X devices of the IMU.

The protection functions of the MicroLogic trip unit remain active during a firmware update.

Use the latest version of EcoStruxure Power Commission software for all firmware updates.

For more information about firmware updates refer to the following documents:

- DOCA0153EN *ComPacT NSX - MicroLogic 5/6 Trip Unit - Firmware Release Notes*, page 7
- DOCA0154EN *ComPacT NSX - MicroLogic 7 Trip Unit - Firmware Release Notes*, page 7
- DOCA0155EN *MicroLogic Trip Units and Control Units - Firmware History*, page 7

After updating the firmware version of the MicroLogic trip unit, use the latest version of EcoStruxure Power Commission software to check the firmware compatibility between the IMU devices. The **Firmware Update** table helps you to diagnose and identify all discrepancy issues between the IMU devices. This table also provides the recommended actions relevant to the detected discrepancies.

Checking the Firmware Version

Check the firmware version with EcoStruxure Power Commission software.

Updating Firmware With EcoStruxure Power Commission Software

NOTICE

INTERRUPTION OF POWER SUPPLY

The MicroLogic trip unit must be continuously powered during the firmware update.

Failure to follow these instructions can result in equipment damage.

The prerequisites for updating the firmware with EcoStruxure Power Commission software are the following:

- The latest version of EcoStruxure Power Commission software must be downloaded and installed on the PC.
- The PC must be connected to a power supply. Standby mode must be deactivated to avoid the possibility of interruption during the update.
- The PC must be connected to the MicroLogic test port through the Service Interface or the USB maintenance interface.

The Administrator password of the MicroLogic trip unit is required to launch the MicroLogic firmware update. For more information, refer to *EcoStruxure Power Commission Online Help*.

Protection Function

What's in This Part

Electrical Distribution Application..... 56
Motor-Feeder Application..... 82

Electrical Distribution Application

What's in This Chapter

Electrical Distribution Protection	57
Long-Time Protection	61
Short-Time Protection.....	64
Instantaneous Protection	67
Ground-Fault Protection.....	68
Earth-Leakage Protection	71
Neutral Protection	76
Zone Selective Interlocking (ZSI).....	79
Using the ZSI Function with ComPacT NSX Circuit Breakers.....	80

Electrical Distribution Protection

Presentation

MicroLogic 5, 6, and 7 trip units provide protection against overcurrents, ground-fault currents, and earth-leakage currents for commercial or industrial applications.

MicroLogic 5, 6, and 7 trip units offer protection characteristics that comply with the requirements of standard IEC/EN 60947-2. For more information, refer to DOCA0187•• *ComPacT NSX - Circuit Breakers and Switch-Disconnectors 100–630 A - User Guide*, page 7.

Description

When choosing the MicroLogic trip unit to use, take account of:

- Overcurrents (overloads and short-circuits)
- Ground-fault current or earth-leakage current
- Conductors that need protection
- The presence of harmonic currents
- Coordination between the devices

Selectivity Between Devices

Coordination between the upstream and downstream devices, especially selectivity, is essential to optimize continuity of service. The large number of options for setting the protection functions on MicroLogic 5, 6, and 7 trip units improves the natural coordination between ComPacT NSX circuit breakers. For more information, refer to LVPED221001EN *ComPacT NSX & NSXm Catalogue*.

Three selectivity techniques can be used:

1. Current selectivity, which corresponds to staging of the long-time protection pickup
2. Time selectivity, which corresponds to staging of the short-time protection pickup
3. Energy selectivity, which corresponds to staging of the circuit breaker energy levels: this applies for very high intensity short-circuit currents.

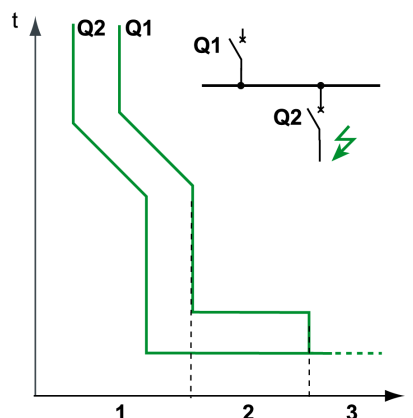

Selectivity Rules

The selectivity rules depend on:

- The type of trip unit on the circuit breakers installed upstream and downstream: electronic or thermal-magnetic.
- The accuracy of the settings.

Selectivity of Overload Protection

For overload protection, the selectivity rules between electronic trip units are as follows:

1. Current selectivity:
 - A ratio of 1.3 between the I_r pickup for long-time protection of the trip unit on the upstream circuit breaker Q1 and that of the trip unit on the downstream circuit breaker Q2 is usually sufficient.
 - The t_r time delay for long-time protection of the trip unit on the upstream circuit breaker Q1 is identical or higher than that of the trip unit on the downstream circuit breaker Q2.
2. Time selectivity:
 - A ratio of 1.5 between the I_{sd} pickup for short-time protection of the trip unit on the upstream circuit breaker Q1 and that of the trip unit on the downstream circuit breaker Q2 is usually sufficient.
 - The t_{sd} time delay for short-time protection of the trip unit on the upstream circuit breaker Q1 is higher than that of the trip unit on the downstream circuit breaker Q2.
 - If the upstream circuit breaker is in position I^2t OFF, the downstream circuit breakers must not be in position I^2t ON.
3. Energy selectivity:
 - Energy selectivity is provided by the circuit breaker design and build characteristics. The selectivity limit can only be guaranteed by the manufacturer.
 - For circuit breakers in the ComPacT NSX circuit breakers range, a ratio of 2.5 between the upstream circuit breaker Q1 and that of the downstream circuit breaker Q2 guarantees total selectivity.

Ground-Fault Protection Selectivity

For ground-fault protection, only the rules for time selectivity should be applied to the protection I_g pickup and t_g time delay:

- A ratio of 1.3 between the I_g pickup for ground-fault protection of the trip unit on the upstream circuit breaker Q1 and that of the trip unit on the downstream circuit breaker Q2 is usually sufficient.
- The t_g time delay for ground-fault protection of the trip unit on the upstream circuit breaker Q1 is higher than that of the trip unit on the downstream circuit breaker Q2.
- If the upstream circuit breaker is in position I^2t OFF, the downstream circuit breakers must not be in position I^2t ON.

Earth-Leakage Protection Selectivity

For earth-leakage protection, only the rules for time selectivity should be applied to the protection $I_{\Delta n}$ pickup and Δt time delay:

- A ratio of 3 between the $I_{\Delta n}$ pickup for earth-leakage protection of the trip unit on the upstream circuit breaker Q1 and that of the trip unit on the downstream circuit breaker Q2 should be applied.

- The Δt time delay for earth-leakage protection of the trip unit on the upstream circuit breaker Q1 is higher than that of the trip unit on the downstream circuit breaker Q2.

Selectivity Limit

Depending on the staging of circuit breaker ratings and protection function settings, selectivity can be:

- Limited (partial selectivity) up to a value I_s of the short-circuit current
- Total (total selectivity), performed irrespective of the value of the short-circuit current

Selectivity Table

Schneider Electric provides selectivity tables showing the type of selectivity (partial or total) between each circuit breaker for its entire range of circuit breakers. These selectivity tables are tested in accordance with the recommendations of standard IEC/EN 60947-2. For more information, refer to LVPED221001EN *ComPacT NSX & NSXm Catalogue*.

MicroLogic 5 Trip Unit

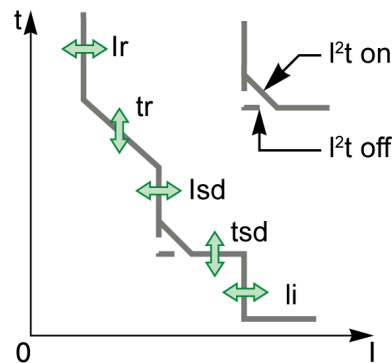

MicroLogic 5 trip units provide the following protection functions:

- Long-time overcurrent protection (I_r , t_r)
- Short-time overcurrent protection (I_{sd} , t_{sd})
- Instantaneous overcurrent protection (I_i)

MicroLogic 6 Trip Unit

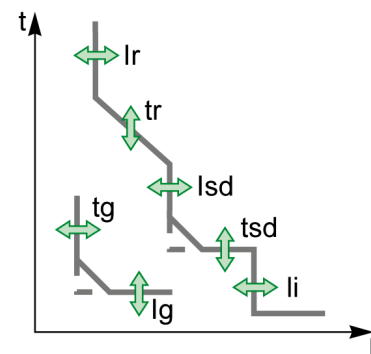

MicroLogic 6 trip units provide the following protection functions:

- Long-time overcurrent protection (I_r , t_r)
- Short-time overcurrent protection (I_{sd} , t_{sd})
- Instantaneous overcurrent protection (I_i)
- Ground-fault protection (I_g , t_g)

MicroLogic 7 Trip Unit with Integrated Earth-Leakage Protection

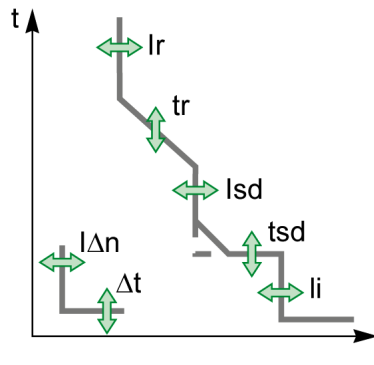

MicroLogic 7 trip units provide the following protection functions:

- Long-time overcurrent protection (I_r , t_r)
- Short-time overcurrent protection (I_{sd} , t_{sd})
- Instantaneous overcurrent protection (I_i)
- Earth-leakage protection ($I_{\Delta n}$, Δt)

Setting the Protection

Set the protection functions:

- On the MicroLogic trip unit, by using the adjustment dials and the keypad (depending on the protection function and the MicroLogic type)
- With EcoStruxure Power Commission software (password-protected)
- By sending a setting command using the communication network (password-protected)

Integrated Instantaneous Protection

In addition to the adjustable instantaneous protection, MicroLogic trip units for electrical distribution protection feature a SELLIM non-adjustable integrated instantaneous protection which can improve selectivity.

Reflex Tripping

In addition to the protection functions integrated in the MicroLogic trip units, ComPacT NSX circuit breakers have reflex protection. This system breaks very high fault currents by mechanically tripping the device with a “piston” actuated directly by the pressure produced in the circuit breaker from a short-circuit. This piston operates the opening mechanism, resulting in ultra-fast circuit breaker tripping.

Long-Time Protection

Presentation

Long-time protection on MicroLogic 5, 6, and 7 trip units protects electrical distribution applications against overload currents. It is identical for MicroLogic 5, 6, and 7 trip units.

Operating Principle

Long-time protection is I²t IDMT (Inverse Definite Minimum Time):

- It incorporates the thermal image function.
- It is set with the I_r pickup and as the t_r trip time delay.

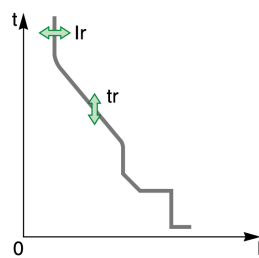

The long-time protection settings are:

- I_r: long-time protection pickup
- t_r: long-time protection time delay

Setting the Long-Time Protection

Set the I_r pickup as follows:

- With the MicroLogic trip unit I_r dial to preset the value and the keypad to fine-tune the value
- With EcoStruxure Power Commission software (password-protected)
- By sending a setting command using the communication network (password-protected)

Set the time delay t_r as follows:

- With the keypad on the MicroLogic trip unit
- With EcoStruxure Power Commission software (password-protected)
- By sending a setting command using the communication network (password-protected)

I_r Pickup Setting Values

The long-time protection tripping range is 1.05–1.20 I_r according to standard IEC/EN 60947-2.

The default I_r pickup setting value is the maximum dial position I_n.

The following table shows the I_r pickup value preset on the dial:

In rating	Preset values of I _r (A) depending on the trip unit I _n rating and the dial position									
	1	2	3	4	5	6	7	8	9	10
40 A	18	18	20	23	25	28	32	36	40	
100 A	40	45	50	55	63	70	80	90	100	
160 A	63	70	80	90	100	110	125	150	160	
250 A	100	110	125	140	150	175	200	225	250	

In rating	Preset values of Ir (A) depending on the trip unit In rating and the dial position								
400 A	160	180	200	230	250	280	320	360	400
630 A	250	280	320	350	400	450	500	570	630

The accuracy range is + 5%/+ 20%.

Use the keypad to fine-tune the setting, in increments of 1 A:

- The setting range maximum is the preset value of the dial.
- The range minimum is 0.9 times the minimum preset value (for the 400 A rating, the setting range minimum is 100 A).

Example: A MicroLogic 5.2 trip unit rated In = 250 A is preset by the dial at 140 A:

- The minimum preset value is 100 A
- The keypad fine-tuning range is 90–140 A

tr Time Delay Setting Values

The setting value displayed is the value of the trip time delay for a current of 6 x Ir.

The default tr time delay setting value is 16 (maximum value) that is, 16 s at 6 x Ir.

The following table shows the value of the trip time delay (in seconds) according to the current in the load for the setting values displayed on-screen:

Current in the load	tr Trip time delay per setting value					
	0.5	1	2	4	8	16
1.5 x Ir	15 s	25 s	50 s	100 s	200 s	400 s
6 x Ir	0.5 s	1 s	2 s	4 s	8 s	16 s
7.2 x Ir	0.35 s	0.7 s	1.4 s	2.8 s	5.5 s	11 s

The accuracy range is -20%/+0%.

Thermal Image

The trip unit uses the calculation of a thermal image to evaluate the conductor heat rise and precisely monitor the thermal state of the conductors.

Example:

Comparison of the heat rise calculation without thermal image (diagram **A**) and with thermal image (diagram **B**):

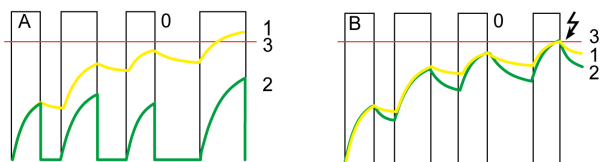

0 Instantaneous current (cyclical) in the load

1 Conductor temperature

2 Current calculated without thermal image (diagram **A**), with thermal image (diagram **B**)

3 Long-time protection pickup: Ir

- Trip unit without thermal image: On each current pulse, the trip unit only considers the thermal effect on the pulse under consideration. No tripping occurs despite the build-up in conductor heat rise.

- Trip unit with thermal image: The trip unit adds the thermal effect of successive current pulses. Tripping occurs based on the actual thermal state of the conductor.

Conductor Heat Rise and Tripping Curves

Use the analysis of the equation of heat rise in a conductor, through which a current I runs, to determine the nature of physical phenomena:

- For low- or medium-intensity currents ($I < I_r$), the conductor equilibrium temperature (for an infinite time) only depends on the current quadratic demand value, page 113. The limit temperature corresponds to a limit current (I_r pickup for trip unit long-time protection).
- For low overcurrents ($I_r < I < I_{sd}$), the conductor temperature only depends on the I^2t energy provided by the current. The limit temperature is an I^2t IDMT curve.
- For high overcurrents ($I > I_{sd}$), the phenomenon is identical if the I^2t function of the short-time protection is active (I^2t ON), page 65.

The following figure (in double log scales) represents a heat rise curve **A** (for an equilibrium temperature θ) and a tripping curve **B** (for the limit temperature θ_L):

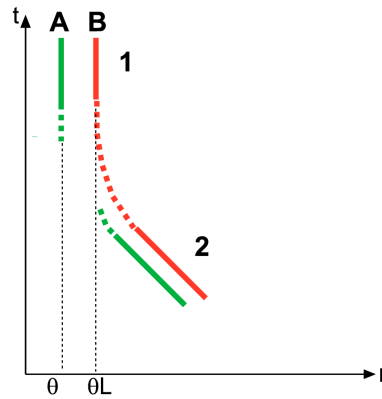

1 Low intensity current zone

2 Low overcurrent zone

Thermal Memory

MicroLogic 5, 6, and 7 trip units incorporate the thermal memory function which helps to ensure that the conductors are cooled even after tripping. Cooling lasts for 20 minutes before or after tripping.

Short-Time Protection

Presentation

Short-time protection on MicroLogic 5, 6, and 7 trip units protects all types of electrical distribution applications against short-circuit currents.

It is identical for MicroLogic 5, 6, and 7 trip units.

Operating Principle

Short-time protection is definite time:

- It incorporates the possibility of an I^2t inverse time curve function.
- It is set using the I_{sd} pickup and the t_{sd} trip time delay.

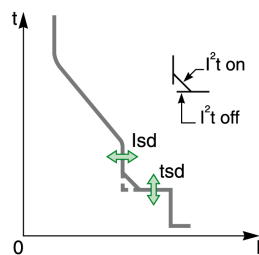

The short-time protection settings are:

- I_{sd} : short-time protection pickup
- t_{sd} : short-time protection time delay
- I^2t : inverse time curve function (ON or OFF)

Setting the Short-Time Protection (MicroLogic 5)

Set the I_{sd} pickup:

- With the MicroLogic trip unit I_{sd} dial to preset the value and the keypad to fine-tune the value
- With EcoStruxure Power Commission software (password-protected)
- By sending a setting command using the communication network (password-protected)

Set the t_{sd} time delay:

- With the keypad on the MicroLogic trip unit
- With EcoStruxure Power Commission software (password-protected)
- By sending a setting command using the communication network (password-protected)

The t_{sd} time delay setting includes activation/deactivation of the I^2t function.

Setting the Short-Time Protection (MicroLogic 6 and 7)

Set the I_{sd} pickup and t_{sd} time delay:

- With the keypad on the MicroLogic trip unit
- With EcoStruxure Power Commission software (password-protected)
- By sending a setting command using the communication network (password-protected)

The t_{sd} time delay setting includes activation/deactivation of the I^2t function.

Isd Pickup Setting Values

The Isd pickup setting value is in multiples of I_r .

The default Isd pickup setting value is $1.5 \times I_r$ (minimum dial value).

The following table shows the setting values (preset by a dial) and setting ranges (set on the keypad) of the Isd pickup:

Type of setting	Value or setting range ($\times I_r$)								
Preset by a dial (MicroLogic 5)	1.5	2	3	4	5	6	7	8	10
Setting range on the keypad ⁽¹⁾ Increment: $0.5 \times I_r$	1.5	1.5–2	1.5–3	1.5–4	1.5–5	1.5–6	1.5–7	1.5–8	1.5–10
(1) For MicroLogic 6 and 7 trip units, the setting range value on the keypad is $1.5–10 \times I_r$.									

The accuracy range is $\pm 10\%$.

tsd Time Delay Setting Values

The following table indicates the setting values for the tsd time delay in seconds (s) with the I^2t function active (I^2t ON) or not active (I^2t OFF). The associated hold and breaking times are shown in milliseconds (ms):

Function	Setting value				
tsd with I^2t OFF (s)	0	0.1	0.2	0.3	0.4
tsd with I^2t ON (s)	–	0.1	0.2	0.3	0.4
Hold time (ms)	20	80	140	230	350
Maximum breaking time (ms)	80	140	200	320	500

The default tsd time delay setting value is 0 s with I^2t OFF.

I^2t Inverse Time Curve Function

Use the I^2t inverse time curve function to improve circuit breaker coordination. Use it when a protection device using inverse time only is installed downstream, for example a fuse protection device.

Example:

The following graphs illustrate an example of selective coordination between a ComPacT NSX630 circuit breaker upstream, and a gG-250 A fuse downstream (calculation performed by the Ecodial software).

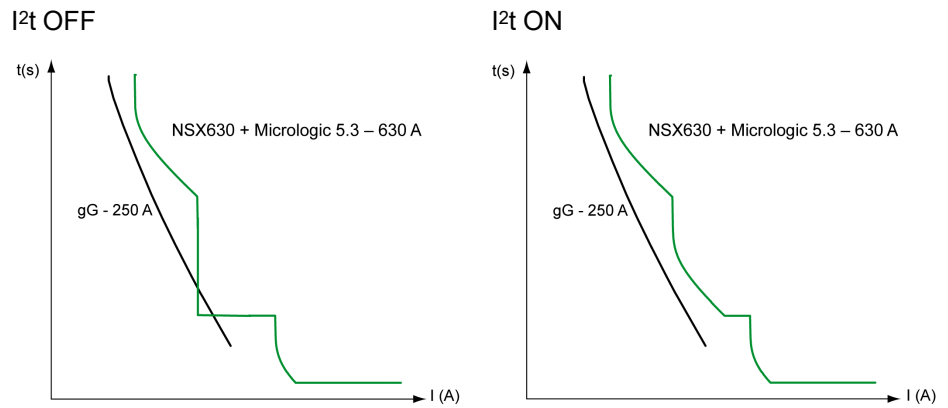

Activate the I^2t function (I^2t ON) on the short-time protection to provide coordination.

Instantaneous Protection

Presentation

Instantaneous protection on MicroLogic 5, 6, and 7 trip units protects all types of electrical distribution applications against very high short-circuit currents.

It is identical for MicroLogic 5, 6, and 7 trip units.

Operating Principle

Instantaneous protection is definite time, set as Ii pickup and without a time delay.

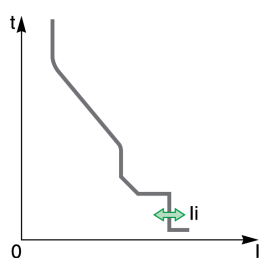

The instantaneous protection setting is:

- Ii: instantaneous protection pickup

Setting the Instantaneous Protection

Set the Ii pickup:

- With the keypad on the MicroLogic trip unit
- With EcoStruxure Power Commission software (password-protected)
- By sending a setting command using the communication network (password-protected)

Ii Pickup Setting Values

The Ii pickup setting value is in multiples of In.

The default Ii pickup setting value is the maximum setting value (15, 12, or 11 x In according to trip unit In rating)

The following table shows the setting ranges and increments according to the MicroLogic trip unit In rating.

Trip unit In rating	Setting range	Increments
100 A and 160 A	1.5–15 x In	0.5 x In
250 A and 400 A	1.5–12 x In	0.5 x In
630 A	1.5–11 x In	0.5 x In

The accuracy range is +/-10%.

The hold time is 10 ms.

The maximum breaking time is 50 ms.

Ground-Fault Protection

Presentation

Ground-fault protection on MicroLogic 6 trip units protects all types of electrical distribution applications against ground-fault currents in the TN-S system.

For more information on ground-fault currents, refer to DOCA0187•• *ComPacT NSX - Circuit Breakers and Switch-Disconnectors 100–630 A - User Guide*, page 7.

Operating Principle

Ground-fault protection is definite time:

- It includes the possibility of an I^2t inverse time curve function.
- Set as I_g pickup and as t_g trip time delay.

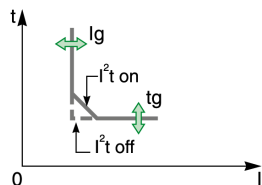

The ground-fault protection settings are:

- I_g : ground-fault protection pickup
- t_g : ground-fault protection time delay
- I^2t : ground-fault protection I^2t curve in ON or OFF position

Setting the Ground-Fault Protection

Set the I_g pickup:

- With the MicroLogic 6 trip unit I_g dial to preset the value and with the keypad to fine-tune the value
- With EcoStruxure Power Commission software (password-protected)
- By sending a setting command using the communication network (password-protected)

Set the t_g time delay:

- With the keypad on the MicroLogic 6 trip unit
- With EcoStruxure Power Commission software (password-protected)
- By sending a setting command using the communication network (password-protected)

The t_g time delay setting includes activation/deactivation of the I^2t function.

I_g Pickup Setting Values

The I_g pickup setting value is in multiples of I_n .

The default I_g pickup setting value is the same as the minimum value read on the dial:

- $0.40 \times I_n$ for trip units rated 40 A
- $0.20 \times I_n$ for trip units rated > 40 A

Ground-fault protection can be deactivated by setting the I_g dial to the OFF position.

Ground-fault protection can be reactivated even with the I_g dial in the OFF position:

- By fine-tuning on the keypad
- With EcoStruxure Power Commission software (password-protected)
- By sending a setting command using the communication network (password-protected)

The following two tables specify the setting values (preset by a dial) and setting ranges (set on the keypad.)

On the keypad, the increment is 0.05 x I_n.

For trip units rated 40 A

Type of setting	Value or setting range (x I _n)								
Preset by a dial	0.40	0.40	0.50	0.60	0.70	0.80	0.90	1	OFF
Setting range on the keypad	0.40	0.40	0.4–0.5	0.4–0.6	0.4–0.7	0.4–0.8	0.4–0.9	0.4–1	0.4–1 + OFF

For trip units rated > 40 A

Type of setting	Value or setting range (x I _n)								
Preset by a dial	0.20	0.30	0.40	0.50	0.60	0.70	0.80	1	OFF
Setting range on the keypad	0.20	0.2–0.3	0.2–0.4	0.2–0.5	0.2–0.6	0.2–0.7	0.2–0.8	0.2–1	0.2–1 + OFF

The accuracy range is +/-10%.

tg Time Delay Setting Values

The tg time delay setting value is in seconds. The hold and breaking times are in milliseconds.

The default tg time delay setting value is 0 s with I_{2t} OFF.

The following table shows the setting values of tg time delay in seconds (s) with the I_{2t} function active (I_{2t} ON) or not active (I_{2t} OFF). The associated hold and breaking times are shown in milliseconds (ms):



Function	Setting value				
tg with I _{2t} OFF (s)	0	0.1	0.2	0.3	0.4
tg with I _{2t} ON (s)	–	0.1	0.2	0.3	0.4
Hold time (ms)	20	80	140	230	360
Maximum breaking time (ms)	80	140	200	320	500

I_{2t} Inverse Time Curve Function

The I_{2t} inverse time curve function for ground-fault protection operates in the same way as the I_{2t} inverse time curve function for short-time protection, page 65.

Testing the Ground-Fault Protection

The ground-fault protection can be tested to check the electronic tripping function of the trip unit. Use the keypad of the MicroLogic 6 trip unit to perform this test.

The ground-fault protection test can be performed with the padlock locked  or unlocked .

Follow these steps to test and reset the ground-fault protection on MicroLogic 6 trip units.

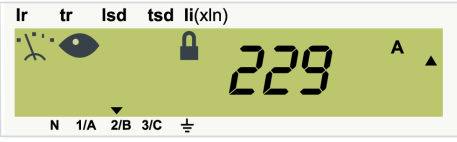
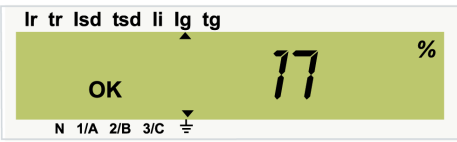
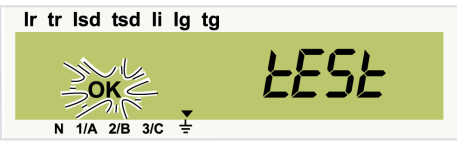
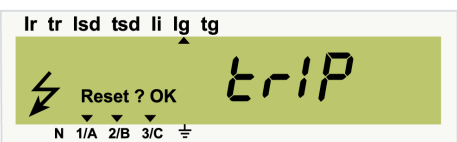
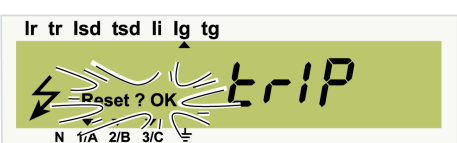
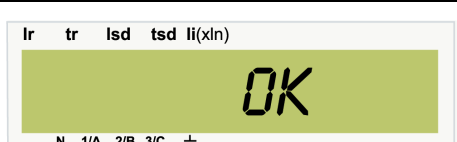
Step	Action	Display
1	Provide a power supply to the trip unit so that the screen displays the result of the test after the circuit breaker trips.	—
2	Select the Instantaneous measurement readout mode (the display is the most heavily loaded phase, in this example Phase 2).	
3	Select the ground-fault current measurement screen (the value is a percentage of the Ig setting).	
4	Access the ground-fault protection test function by pressing OK . The tEST pictogram appears and the OK pictogram blinks.	
5	Prompt the ground-fault protection test by pressing OK . The circuit breaker trips. The ground-fault protection trip screen is displayed.	
6	Acknowledge the ground-fault trip screen by pressing OK . The Reset? OK pictogram blinks.	
7	Confirm by pressing OK again. The confirmation OK is displayed for 2 s.	

Earth-Leakage Protection

Presentation

Earth-leakage protection on MicroLogic 7 trip units provides protection against low intensity fault currents to ground for:

- All types of electrical distribution applications
- People, according to the earth-leakage protection setting used

Earth-leakage protection is designed for installations with TT or TN-S grounding system.

The MicroLogic 7 electronic trip unit is available in two versions for earth-leakage detection:

- The Trip version trips when earth-leakage is detected.
- The Alarm version measures the earth-leakage current and indicates an earth-leakage fault on the display screen.

Operating Principle

Earth-leakage protection is definite time.

The earth-leakage protection threshold $I_{\Delta n}$ sets the level of earth-leakage current at which the circuit breaker trips when reaching the earth-leakage protection time delay Δt .

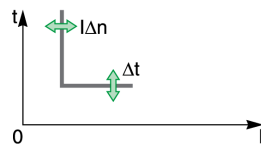

The earth-leakage protection settings are:

- $I_{\Delta n}$: earth-leakage protection pickup
- Δt : earth-leakage protection time delay

Setting the Earth-Leakage Protection

Set the $I_{\Delta n}$ pickup with the MicroLogic 7 trip unit $I_{\Delta n}$ dial.

Set the Δt time delay as follows:

- With the keypad on the MicroLogic 7 trip unit
- With EcoStruxure Power Commission software (password-protected)

$I_{\Delta n}$ Pickup Setting Values

Trip unit rating I_n (A)	Pickup $I_{\Delta n}$									
	$I_{\Delta n}$ dial position	1	2	3	4	5	6	7	8	9
40, 100, 160, and 250 A	30 mA	30 mA	100 mA	300 mA	500 mA	1 A	3 A	5 A	10 A	OFF
400 and 570 A ⁽¹⁾	300 mA	300 mA	500 mA	1 A	3 A	5 A	10 A	10 A	10 A	OFF

(1) Maximum setting at 570 A for thermal reasons, to be adapted with breaking block up to 630 A

The accuracy range is +/-10%.

Δt Time Delay Setting Values

When IΔn is set to the 30 mA, the earth-leakage protection acts immediately (instantaneous tripping), whatever the setting of the Δt time delay.



For other IΔn values (> 30 mA), the Δt time delay can be set to one of the following values:

- 0 s
- 60 ms
- 150 ms
- 500 ms
- 1 second

Testing the Earth-Leakage Protection (With Trip) Using Test Button

On the Trip version of MicroLogic 7 trip units, the earth-leakage protection must be tested regularly by using the test button **T**. Pressing the test button simulates a real leakage current passing through the toroid and the circuit breaker trips.

When the earth-leakage protection pickup IΔn is set to the **OFF** position, pressing the test button has no effect.

The earth-leakage function test can be performed with the padlock locked  or unlocked .

Follow these steps to test and reset the earth-leakage protection on MicroLogic 7 trip units:

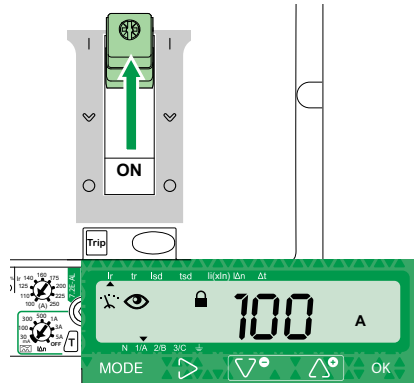

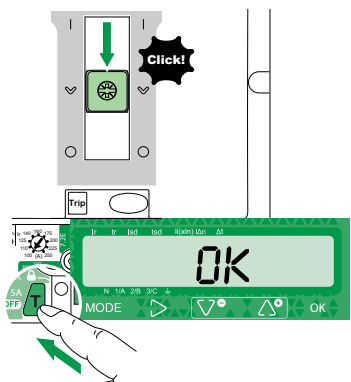
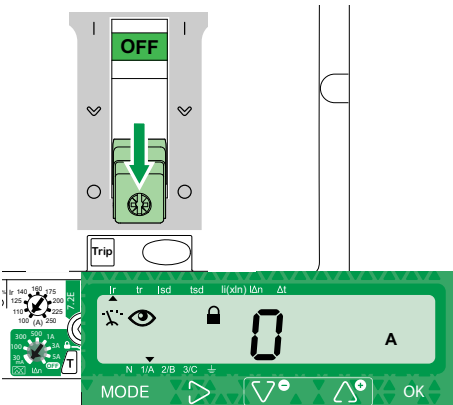
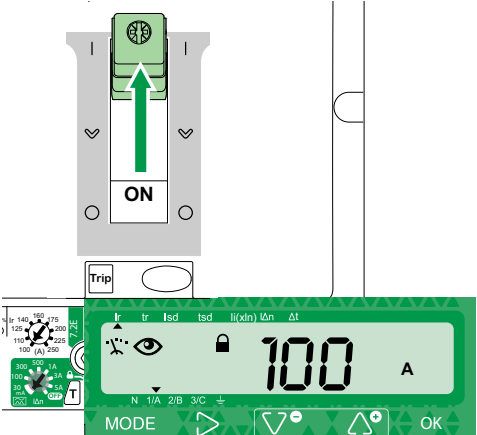
Step	Action	Display
1	Energize the circuit breaker.	—
2	Open the protective cover of the trip unit.	—
3	Provide a power supply to the trip unit so that the screen displays the result of the test after the circuit breaker trips.	—
4	Push the toggle handle from the O (OFF) position to the I (ON) position. The circuit breaker is closed.	

Step	Action	Display
5	Press the test button T : the circuit breaker trips. OK is displayed on the screen for two seconds and then the screen displays 0 A. NOTE: If the circuit breaker does not trip, the earth-leakage protection is no longer active. Analyze the cause and replace the MicroLogic 7 trip unit or the circuit breaker.	
6	Push the toggle handle from the (Trip) position to the O (OFF) position.	
7	Push the toggle handle from the O (OFF) position to the I (ON) position. The circuit breaker is closed.	

Testing the Earth-Leakage Alarm (Without Trip) Using Test Button

On the Alarm version of the MicroLogic 7 trip unit, the earth-leakage alarm can be tested by using the test button **T**. Pressing the test button simulates a real leakage current passing through the toroid. The circuit breaker does not trip.

When the earth-leakage alarm pickup $I\Delta n$ is set to the **OFF** position, pressing the test button has no effect.

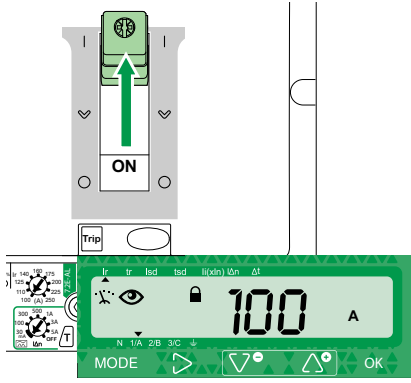
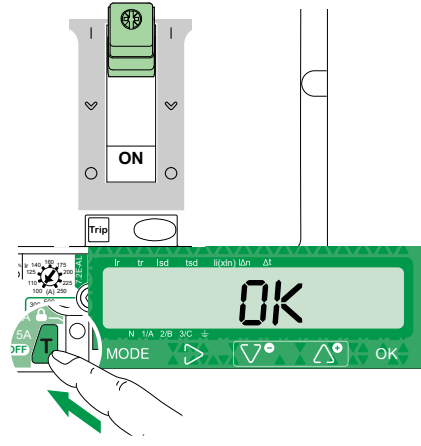

The earth-leakage function test can be performed with the padlock locked  or unlocked .

Follow these steps to test the earth-leakage alarm on MicroLogic 7AL trip units:





Step	Action	Display
1	Energize the circuit breaker.	—
2	Open the protective cover of the trip unit.	—
3	Provide a power supply to the trip unit.	—
4	Push the toggle handle from the O (OFF) position to the I (ON) position. The circuit breaker is closed.	
5	Press the test button T : OK is displayed on the screen for two seconds, and then the previous screen is displayed. NOTE: If nOK is displayed on the screen, the earth-leakage alarm is no longer active. Replace the MicroLogic 7AL trip unit.	

Testing the Earth-Leakage Function (Without Trip) Using Keypad Only

On the Trip and Alarm versions of the MicroLogic 7 trip unit, the earth-leakage tripping chain (or earth-leakage detection for the Alarm version) (except mechanism and pole operation) can be tested, without tripping the circuit breaker, by using the keypad.

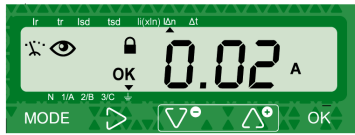
The earth-leakage function test can be performed with the padlock locked  or unlocked .

Follow these steps to test the earth-leakage protection alarm on MicroLogic 7AL trip units:

Step	Action	Using	Display
1	Select the earth-leakage measurement screen.		
2	Access the earth-leakage function test by pressing OK . The tEst pictogram appears and the OK pictogram blinks.		
3	Prompt the earth-leakage function test by pressing OK . The result of the test (OK or nOK) is displayed on the screen after two seconds. NOTE: If nOK is displayed on the screen, test the earth-leakage function by using the test button T .		
4	After two seconds the screen returns to the screen displayed before the test	–	–

Earth-Leakage Test History

The last ten earth-leakage tests are recorded in an earth-leakage test history, page 169. Tests performed using the **T** test button and tests using the keypad are logged in the same history.

The history records:

- Type of test: with trip or without trip
- Date of test
- Result of test (**OK** or **nOK**)

The earth-leakage test history can be consulted:

- With EcoStruxure Power Commission software.
- On a remote controller using the communication network.

Resetting the Circuit Breaker After an Earth-Leakage Fault Detection

Resetting the earth-leakage function after an earth-leakage fault detection (with or without trip) depends on the version:

- For the Trip version, reset the circuit breaker by moving the handle from **Trip** to **O (OFF)** position, and then to **I (ON)** position. Acknowledge the earth-leakage trip screen by pressing **OK**.
- For the Alarm version, acknowledge the earth-leakage trip screen by pressing **OK**.

Resetting the earth-leakage function after an earth-leakage protection test is described in the procedure for each test.

Neutral Protection

Presentation

Neutral protection on MicroLogic 5, 6, and 7 trip units protects all types of electrical distribution applications against overload and short-circuit currents.

It is available on:

- MicroLogic 5, 6, and 7 trip units for 4-pole circuit breakers
- MicroLogic 5 and 6 trip units with ENCT option for 3-pole circuit breakers

Description

Normally, the phase protection protects the neutral conductor (if it is distributed and identical to the phases in size, that is, full neutral).

The neutral must have specific protection if:

- It is reduced in size compared to the phases
- Nonlinear loads generating third order harmonics (or multiples thereof) are installed

It may be necessary to switch off the neutral for operational reasons (multiple source diagram) or safety reasons (working with power off).

To summarize, the neutral conductor can be:

- Non-distributed (3-pole circuit breaker)
- Distributed, not switched off and not protected (3-pole circuit breaker)
- Distributed, not switched off but protected (3-pole circuit breaker with ENCT option)
- Distributed, switched off and protected (4-pole circuit breaker)

ComPacT NSX circuit breaker trip units are suitable for all protection types.

Circuit breaker	Possible types	Neutral protection
3-pole circuit breaker	3P, 3D	None
3-pole circuit breaker with ENCT option	3P, 3D	None
	3P, 3D + N/2	Half neutral
	3P, 3D + N	Full neutral
	3P, 3D + OSN	Oversized neutral
4-Pole Circuit Breaker	4P, 3D	None
	4P, 3D + N/2	Half neutral
	4P, 4D	Full neutral
	4P, 4D + OSN	Oversized neutral
P: Pole; D: Trip unit; N: Neutral protection		

Operating Principle

Neutral protection has the same characteristics as phase protection:

- Its pickup is in proportion with the long-time I_r and short-time I_{sd} protection pickups.
- It has the same trip time delay values as the long-time I_r and short-time I_{sd} protections.

- Its instantaneous protection is identical.

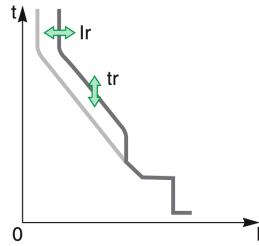

The neutral protection settings are:

- Ir: long-time protection pickup
- tr: long-time protection time delay
- IN: neutral protection pickup

Setting the Neutral Protection

4-pole trip unit

Set the IN pickup:

- With the keypad on the MicroLogic trip unit
- With EcoStruxure Power Commission software (password-protected)
- By sending a setting command using the communication network (password-protected)

3-pole trip unit

Set the neutral declaration and the IN pickup:

- With the keypad on the MicroLogic trip unit
- With EcoStruxure Power Commission software (password-protected)
- By sending a setting command using the communication network (password-protected)

Neutral Protection Setting Value

MicroLogic 5, 6, and 7 trip units incorporate the OSN (Oversized Neutral) function, which manages protection of the neutral conductor when third-order harmonic currents (and multiples thereof) are present.

The following table shows the setting values of the neutral long-time protection and neutral short-time protection pickups, according to the value of the IN/Ir function:

IN/Ir function	Long-time pickup value Ir(IN)	Short-time pickup value I _{sd} (IN)
OFF	N/A	N/A
0.5 ⁽¹⁾	I _r /2	I _{sd} /2
1	I _r	I _{sd}

(1) For the MicroLogic 7 trip unit with 40 A rating, the IN/Ir = 0.5 setting is not available.

The setting values are identical for the phases, the neutral long-time, and short-time protection time delays.

The following table details the setting values of the neutral protection pickups (set to OSN) according to the phase protection pickup I_r setting and the I_n rating of the 4-pole trip unit.

I _r /I _n values	Long-time pickup value Ir(IN)	Short-time pickup value I _{sd} (IN)
I _r /I _n < 0.63	1.6 x I _r	1.6 x I _{sd}
0.63 < I _r /I _n < 1	I _n	I _n x I _{sd} /I _r

Selection of the ENCT Option

The ENCT option is an external neutral CT for a 3-pole MicroLogic 5 or 6 trip unit.

The following table indicates the part number for the ENCT option installed according to the In rating of the MicroLogic trip unit or the need for OSN protection:

In rating (A)	Neutral protection limited to In	OSN neutral protection > In
40	LV429521	LV429521
100	LV429521	LV429521
160	LV430563	LV430563
250	LV430563	LV432575
400	LV432575	LV432575
630	LV432575	No ⁽¹⁾

(1) For the 630 A rating, the OSN function is limited to In (= 630 A).

Installing the ENCT Option

Step	Action
1	Connect the neutral conductor to the ENCT option primary (terminals H1, H2).
2	Remove (if existing) the jumper, between terminals T1 and T2 of the MicroLogic trip unit.
3	Connect the ENCT option secondary (terminals T1, T2) to terminals T1 and T2 of the MicroLogic trip unit.
4	Declare the ENCT option when setting the protection functions for the MicroLogic trip unit.

NOTE: If the ENCT option is declared before its installation, the MicroLogic trip unit trips and displays the ENCT screen. Either install the ENCT option or connect a jumper between terminals T1 and T2 on the MicroLogic trip unit. Clear the ENCT screen by pressing the **OK** key twice (enter and confirm).

Zone Selective Interlocking (ZSI)

Presentation

Use zone selective interlocking (ZSI) to reduce the electrodynamic stress on equipment when using selective coordination.

Principle of the ZSI Function

ZSI improves coordination by being selective about the position of the electrical fault. A signal wire links the installed circuit breaker trip units and manages the trip time delay for upstream circuit breaker Q1 according to the electrical fault position.

The trip units on circuit breakers Q1 and Q2 have the same time delay settings as with selective coordination.

Diagram 3

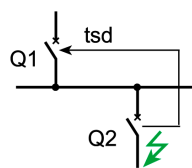
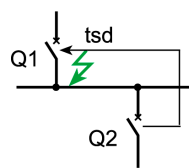

Diagram 4



- If an electrical fault occurs downstream of downstream circuit breaker Q2 (diagram 3), the trip units on circuit breakers Q1 and Q2 detect the electrical fault simultaneously. The trip unit on circuit breaker Q2 sends a restraint signal to the trip unit on circuit breaker Q1, which remains set on its time delay tsd . Circuit breaker Q2 trips and clears the electrical fault (instantaneously if circuit breaker Q2 is not delayed).

The other users downstream of circuit breaker Q1 still have power, the energy availability is optimized.

- If an electrical fault occurs downstream of circuit breaker Q1 (diagram 4), the trip unit on circuit breaker Q1 does not receive a restraint signal from the trip unit on circuit breaker Q2. Time delay tsd is therefore inhibited. Circuit breaker Q1 trips and clears the electrical fault on the equipment instantaneously.

The electrodynamic stress created by the short-circuit current on the equipment is reduced to the minimum.

The ZSI function can be used to optimize the availability of energy (just like selective coordination) and reduce electrodynamic stress on the equipment. The ZSI function is applicable to both short-time and ground-fault protection.

Using the ZSI Function with ComPacT NSX Circuit Breakers

Description

The MicroLogic 5 and 6 trip units support ZSI. The following figure explains how the signal wire is connected to the trip unit:

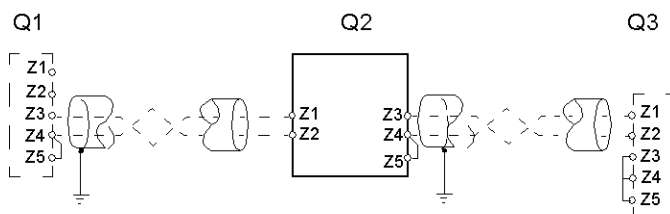

Q1 Upstream circuit breaker

Q2 Circuit breaker to be wired

Q3 Downstream circuit breaker

Z1 ZSI-OUT source

Z2 ZSI-OUT

Z3 ZSI-IN source

Z4 ZSI-IN ST short-time protection

Z5 ZSI-IN GF ground-fault protection (MicroLogic 6)

Outputs Z3, Z4, and Z5 are only available on ComPacT NSX400/630 circuit breakers.

The short-time and ground-fault protection time delay settings (MicroLogic 6) for trip units using ZSI must comply with the rules relating to selective coordination.

Connection Principles

The following figures show the options for connecting devices together:

Protection	Connection diagram	
Ground-fault and short-time protection (MicroLogic 6)		Connect output Z2 of the trip unit on the downstream circuit breaker Q2 to inputs Z4 and Z5 of the trip unit on the upstream circuit breaker Q1.
Short-time protection		<ul style="list-style-type: none"> Connect output Z2 of the trip unit on the downstream circuit breaker Q2 to input Z4 of the trip unit on the upstream circuit breaker Q1. Short circuit inputs Z3 and Z5.
Ground-fault protection (MicroLogic 6)		<ul style="list-style-type: none"> Connect output Z2 of the trip unit on the downstream circuit breaker Q2 to input Z5 of the trip unit on the upstream circuit breaker Q1. Short circuit inputs Z4 and Z3.

NOTE: When ZSI is not used downstream, short circuit inputs Z3, Z4, and Z5. The setting of the short-time and ground-fault protection time delays can be inhibited if this principle is not applied.

Multi-Source Distribution

If a number of circuit breakers are installed upstream (as with multi-source distribution), the same principles apply.

Connect a downstream circuit breaker to all the circuit breakers installed directly upstream:

- Connect all the commons (outputs Z1/inputs Z2) to one another.
- Connect output Z2 simultaneously to inputs Z3, Z4, or Z5 of all the circuit breaker trip units installed upstream.

NOTE: Management of this configuration does not require any additional relays for ZSI to be controlled for the sources used.

Connection Wire Characteristics

The following table indicates the characteristics of the inter-device signal wire:

Characteristics	Values
Impedance	50 Ω per 300 m
Maximum length	300 m
Type of cable	Shielded twisted (Belden 8441 or equivalent)
Permissible conductor cross-section	0.4–1.5 mm ²
Interconnection limit on inputs Z3, Z4, and Z5 (to downstream devices)	15 devices
Interconnection limit on outputs Z1 and Z2 (to upstream devices)	5 devices

NOTE: When using the ZSI to connect ComPacT NSX circuit breakers with MasterPacT or ComPacT NS circuit breakers, add an RC filter (part number LV434212) to the circuit by a MasterPacT or ComPacT NS circuit breaker. For more information, refer to LVPED221001EN *ComPacT NSX & NSXm Catalogue*, page 7.

The following figure shows the connection of the RC filter (part number LV434212).

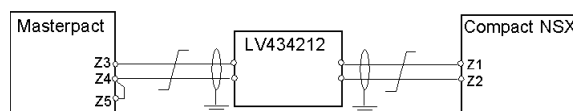

Testing the ZSI Function

Test connection and operation of ZSI using EcoStruxure Power Commission software and the Service Interface.

Motor-Feeder Application

What's in This Chapter

Protection for Motor-Feeders	83
Long-Time Protection	88
Short-Time Protection	91
Instantaneous Protection	92
Ground-Fault Protection	93
Phase Unbalance Protection	96
Motor Jam Protection	99
Underload Motor Protection	101
Long-Start Motor Protection	103

Protection for Motor-Feeders

Presentation

MicroLogic 6 E-M trip units on ComPacT NSX circuit breakers:

- Provide protection for direct-on-line motor-feeders (direct-on-line starting is the most widely used type of motor-feeder).
- Integrate the basic protections (overload, short-circuit, and phase unbalance) for the motor-feeder and additional protections and/or specific options for motor applications.
- Allow protection and coordination of the motor-feeder components that comply with the requirements of standard IEC/EN 60947-2 and IEC/EN 60947-4-1. For more information, refer to DOCA0187** *ComPacT NSX - Circuit Breakers and Switch-Disconnectors 100–630 A - User Guide*, page 7.

Description

ComPacT NSX circuit breakers equipped with the MicroLogic 6 E-M trip unit can be used to create motor-feeders with two devices.

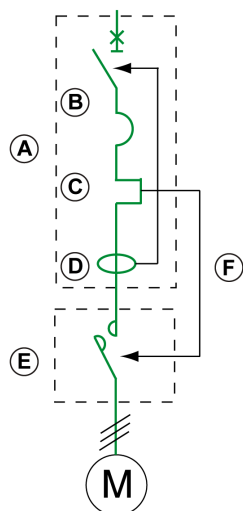

A ComPacT NSX circuit breaker equipped with a MicroLogic 6 E-M trip unit

B Short-circuit protection

C Overload protection

D Ground-fault current protection

E Contactor

F SDTAM Module Option

Operating States

The MicroLogic 6 E-M trip unit considers the application to be operating as soon as the 10% of I_r pickup is crossed in a positive direction by the motor current.

Two operating states are considered:

- Startup state
- Steady state

Startup State

The MicroLogic 6 E-M trip unit considers the application to be in startup state according to the following criteria:

- Start: As soon as the 10% of I_r pickup is crossed in a positive direction by the motor current
- End: As soon as the I_d pickup is crossed in a negative direction or at maximum after a t_d time delay defined as follows:
 - If long-start protection is not activated (factory setting), the I_d pickup equals $1.5 \times I_r$ and the t_d time delay equals 10 s (non-adjustable parameters).
Exceeding the 10 s time delay does not result in tripping.
 - If long-start protection is activated, page 103, the I_d pickup equals I_{long} and the t_d time delay equals t_{long} (adjustable parameters).
Exceeding the t_{long} time delay results in long-start protection tripping.

NOTE: The MicroLogic trip unit measurement electronics filter the subtransient state (first current peak of approximately 20 ms on contactor closing). This current peak is not therefore taken into account when assessing whether the I_d pickup has been crossed.

Steady State

The MicroLogic 6 E-M trip unit considers the application to be in steady state according to the following criteria:

- Start: As soon as startup ends
- End: As soon as the 10% of I_r pickup is crossed in a negative direction by the motor current

Operating Diagram

The following diagram shows the two operating states for a motor application:

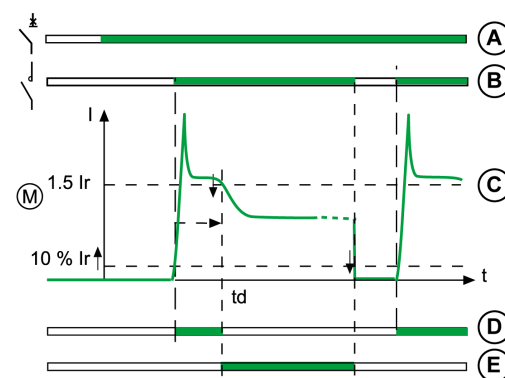

A ComPacT NSX circuit breaker status (green = ON position)

B Contactor status (green = ON position)

C Current in the motor application

Operating states:

D: Startup state

E: Steady state (the active states are shown in green)

Protection Functions

The following figure and table define the protection functions for MicroLogic 6 E-M trip units:

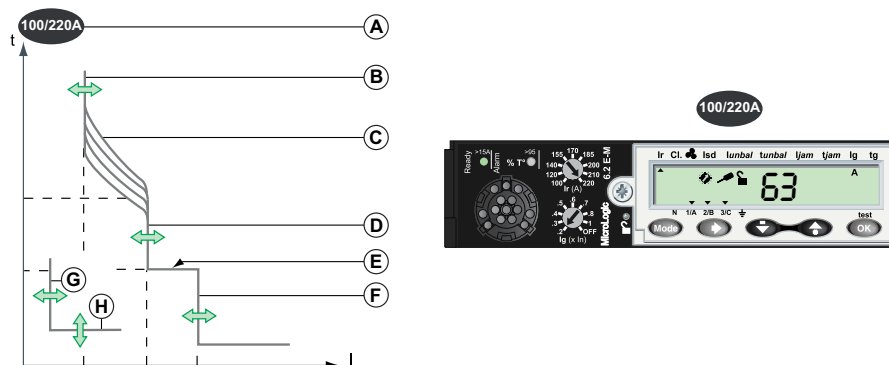

Item	Parameter	Description	Adjustable
A	In	Trip unit setting range: Minimum setting/maximum setting = trip unit In rating	No
B	Ir	Long-time protection pickup	L Yes
C	Cl	Long-time protection trip class	
D	Isd	Short-time protection pickup	S Yes
E	tsd	Short-time protection time delay	
F	Ii	Instantaneous protection pickup	I No
G	Ig	Ground-fault protection pickup	G Yes
H	tg	Ground-fault protection time delay	
	Iunbal	Phase unbalance protection pickup	Yes
	Iunbal	Phase unbalance protection time delay	

Each function is reviewed in detail on the following pages.

Additional Protection

The MicroLogic 6 E-M trip unit incorporates additional protection functions for motor applications.

Protection	Default Activation	Default Setting	SDTAM Activation
Motor jam protection	OFF	Ijam: OFF, tjam: 5 s	Yes
Underload motor protection	OFF	Iund: OFF, tund: 10 s	Yes
Long-start motor protection	OFF	Ilong: OFF, tlong: 10 s	No

The additional protections are activated for startup or steady state or in both cases.

Setting the Protection

Set the protection functions:

- On the MicroLogic trip unit, by using the adjustment dials and the keypad (depending on the protection function and the MicroLogic type).

- With EcoStruxure Power Commission software (password-protected)
- By sending a setting command using the communication network (password-protected)

Reflex Tripping

In addition to the protection functions integrated in the MicroLogic trip units, ComPacT NSX circuit breakers have reflex protection. This system breaks very high fault currents by mechanically tripping the device with a “piston” actuated directly by the pressure produced in the circuit breaker from a short-circuit. This piston operates the opening mechanism, resulting in ultra-fast circuit breaker tripping.

SDTAM Module Option

The SDTAM module early tripping function can be used to command contactor opening 400 ms before the calculated circuit breaker tripping in the case of:

- Long-time protection
- Phase unbalance protection
- Motor jam protection
- Underload motor protection

The contactor can be closed again automatically or manually depending on the setting of the SDTAM module. For more information, refer to DOCA0187** *ComPacT NSX - Circuit Breakers and Switch-Disconnectors 100–630 A - User Guide*, page 7.

Example of Using the SDTAM Module

The following figures illustrate operation of the Motor jam protection without the SDTAM module (diagram I) and with the SDTAM module (diagram II):

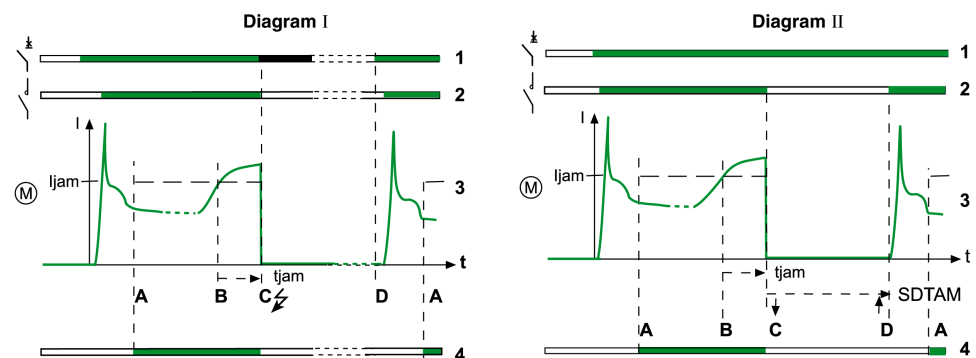

1 ComPacT NSX circuit breaker status

White: Open; Green: Closed; Black: Tripped

2 Contactor status (SD contact in the contactor coil)

White: Open; Green: Closed

3 Motor current

4 Monitoring by motor jam protection

White: Not active (startup state). Green: Active (steady state)

Analysis of Operation

The following table describes operation without the SDTAM module (diagram I).

Event	Comments
A	Application motor switches to steady state. Motor jam protection monitoring is activated.
B	Occurrence of an overload current on the application (for example, rotor braked due to high viscosity of one of the mixing fluids) The Motor jam protection tjam time delay is actuated as soon as the motor current crosses the Ijam pickup.
C	End of Motor jam protection time delay Motor jam protection causes the ComPacT NSX circuit breaker to trip.
D	Application returned to service manually after the motor has cooled and the circuit breaker has closed again.

The following table describes operation with the SDTAM module (diagram II).

Event	Comments
A	Identical to diagram I
B	Identical to diagram I
C	400 ms before the end of the Motor jam protection time delay, the SDTAM module: <ul style="list-style-type: none"> • Commands the contactor to open (output OUT2) • Sends a fault indication (output OUT1) Both outputs are activated for a time delay (which can be set between 1 and 15 minutes).
D	Application contactor returned to service automatically: the time delay allows the motor to cool down.

The SDTAM module can be set to the **OFF** position: the application is returned to service manually (by deactivating the SDTAM module power supply).

Long-Time Protection

Presentation

Long-time protection on MicroLogic 6 E-M trip units protects all types of motor applications against overload currents.

Operating Principle

Long-time protection is I^2t IDMT (Inverse Definite Minimum Time):

- It incorporates the motor thermal image function.
- It can be configured as the I_r pickup and as the trip class Class.

Tripping curve:

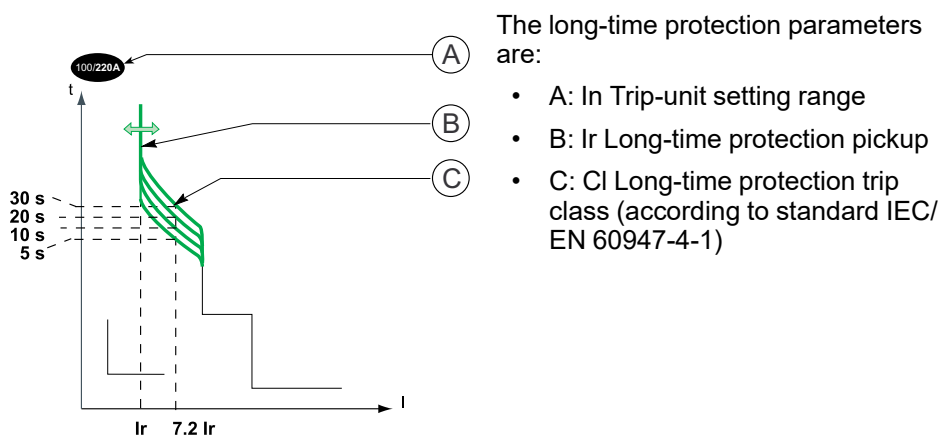

NOTE: The SDTAM module early tripping protection function can be used to command contactor opening, page 86.

Setting the Long-Time Protection

Set the I_r pickup:

- With the MicroLogic trip unit I_r dial to preset the value and the keypad to fine-tune the value
- With EcoStruxure Power Commission software (password-protected)
- By sending a setting command using the communication network (password-protected)

Set the trip class CI:

- With the keypad on the MicroLogic trip unit
- With EcoStruxure Power Commission software (password-protected)
- By sending a setting command using the communication network (password-protected)

I_r Pickup Setting Value

The default I_r pickup setting value is I_n (maximum dial value).

The overload or thermal protection tripping range is $1.05\text{--}1.20 \times I_r$ according to standard IEC/EN 60947-2.

The I_r pickup is preset by a dial.

In Rating	Preset values of I_r (A) depending on the trip unit In rating and the dial position								
25 A	12	14	16	18	20	22	23	24	25
50 A	25	30	32	36	40	42	46	47	50
80 A	35	42	47	52	57	60	63	72	80
150 A	70	80	90	100	110	120	133	140	150
220 A	100	120	140	155	170	185	200	210	220
320 A	160	180	200	220	240	260	280	300	320
500 A	250	280	320	360	380	400	440	470	500

The accuracy range is + 5%/+ 20%.

Use the keypad to fine-tune the setting, in increments of 1 A:

- The setting range maximum is the preset value displayed by the dial.
- The setting range minimum is the minimum preset value.

Example:

A MicroLogic 6 E-M trip unit $I_n = 500$ A is preset by the dial at 470 A. The fine-tuning range on the keypad is 250–470 A.

Trip Class Setting Value

The class is set via the keypad, using any of the four defined values: 5, 10, 20, and 30.

The trip class corresponds to the value of the trip time delay for a current of $7.2 \times I_r$ according to standard IEC/EN 60947-4-1.

The factory class setting value is 5 (minimum value).

The following table shows the value of the trip time delay depending on the current in the load for all four trip classes.

Current in the load	Trip class CI			
	5	10	20	30
	tr Trip time delay (s)			
$1.5 \times I_r$	120	240	400	720
$6 \times I_r$	6.5	13.5	26	38
$7.2 \times I_r$	5	10	20	30

Motor Thermal Image

The model representing heat rise and cooling in a motor load is identical to that used for the conductors. It is constructed according to the algorithm for calculating the thermal demand but this model takes account of the iron and copper losses.

The following figure represents the limit curves for the iron and copper components calculated by the MicroLogic 6 E-M trip unit (for class 20):

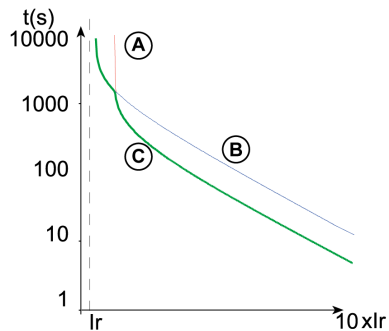

A Limit temperature curve for copper

B Limit temperature curve for iron

C Tripping curve (low envelope)

Thermal Memory

MicroLogic 6 E-M trip units incorporate a thermal memory which ensures that the conductors are cooled even after tripping: cooling lasts for 20 minutes before or after tripping.

Cooling Fan

By default, the motor thermal image is calculated taking account of the fact that the motor is self-cooled (fan mounted on the shaft end).

If the motor is force-cooled (forced ventilation), the calculation of the thermal image takes account of the shortest time constants for the cooling calculation.

The cooling ventilation parameters (**Auto** or **Moto** position) are set on the MicroLogic trip unit keypad or using EcoStruxure Power Commission software.

Short-Time Protection

Presentation

Short-time protection on MicroLogic 6 E-M trip units protects all types of motor applications against short-circuit currents.

Operating Principle

Short-time protection is definite time. It can be configured as the I_{sd} pickup.

Tripping curve:

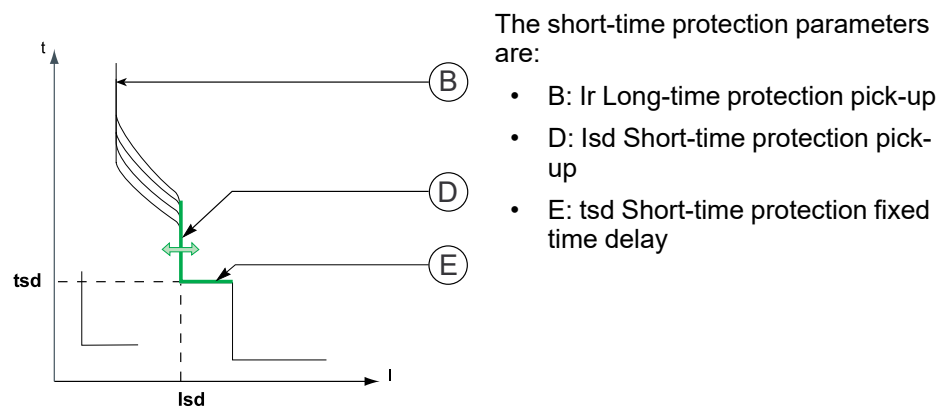

Setting the Short-Time Protection

Set the I_{sd} pickup and t_{sd} time delay:

- With the keypad on the MicroLogic trip unit
- With EcoStruxure Power Commission software (password-protected)
- By sending a setting command using the communication network (password-protected)

I_{sd} Pickup Setting Value

The I_{sd} pickup setting value is in multiples of I_r .

The default I_{sd} pickup setting value is $5 \times I_r$ (minimum value).

The pickup setting range on the keypad is $5-13 \times I_r$. The increment is $0.5 \times I_r$.

The accuracy range is $\pm 15\%$.

t_{sd} Time Delay Value

The time delay cannot be adjusted.

- The hold time is 20 ms.
- The maximum breaking time is 60 ms.

Instantaneous Protection

Presentation

Instantaneous protection on MicroLogic 6 E-M trip units protects all types of motor applications against very high intensity short-circuit currents.

Operating Principle

Instantaneous protection is fixed: the pickup value is determined by the trip unit rating. Protection is instantaneous.

Tripping curve:

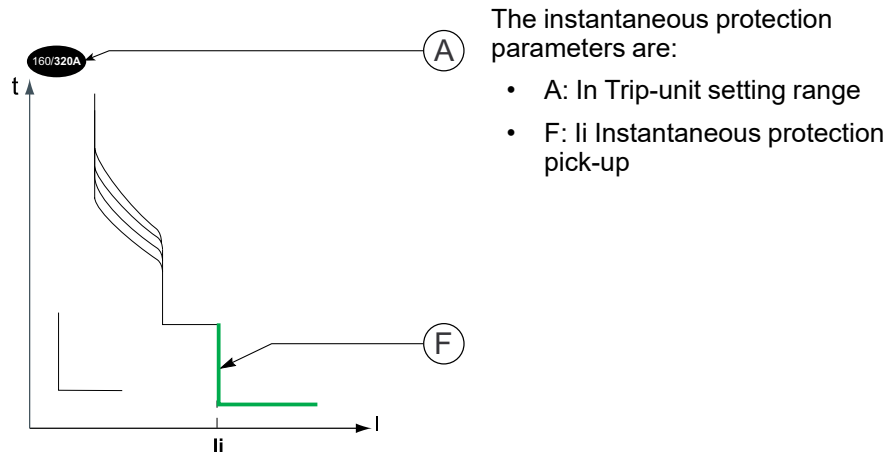

I_i Pickup Value

The I_i pickup value is directly determined by the trip unit I_n rating and is $I_n \times 15$.

I_i pickup value according to the MicroLogic trip unit I_n rating (accuracy range $\pm 10\%$).

I_n rating (A)	25	50	80	150	220	320	500
Instantaneous pickup (A)	425	750	1200	2250	3300	4800	7500

The hold time is 0 ms.

The maximum breaking time is 30 ms.

Ground-Fault Protection

Presentation

Ground-fault protection on MicroLogic 6 E-M trip units protects all types of motor applications against ground-fault currents in the TN-S system. For more details, refer to DOCA0187** *ComPacT NSX - Circuit Breakers and Switch-Disconnectors 100–630 A - User Guide*, page 7.

Operating Principle

Ground-fault protection is definite time. It can be configured as I_g pickup and as t_g trip time delay.

Tripping curve:

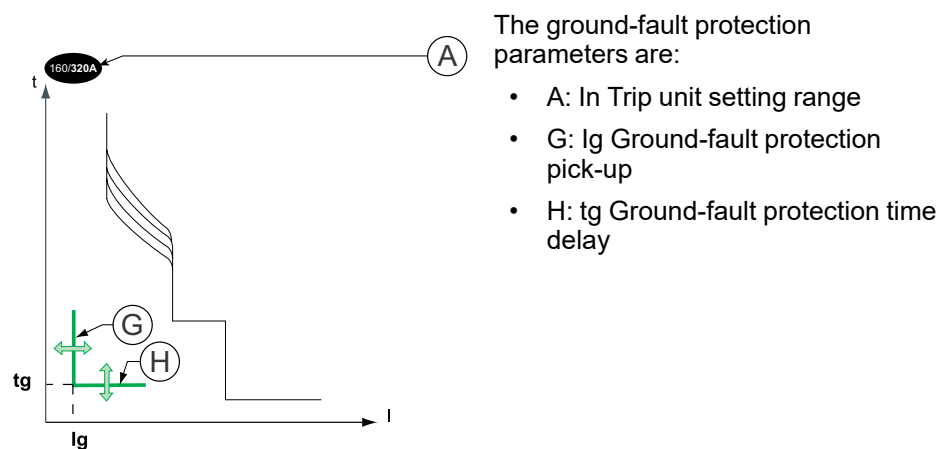

Setting the Ground-Fault Protection

Set the I_g pickup:

- With the MicroLogic trip unit I_g dial to preset the value and the keypad to fine-tune the value
- With EcoStruxure Power Commission software (password-protected)
- By sending a setting command using the communication network (password-protected)

Set the t_g time delay:

- With the keypad on the MicroLogic trip unit
- With EcoStruxure Power Commission software (password-protected)
- By sending a setting command using the communication network (password-protected)

I_g Pickup Setting Values

The I_g pickup setting value is in multiples of I_n .

The default I_g pickup setting value is the same as the minimum dial value:

- $0.60 I_n$ for trip units rated 25 A
- $0.30 I_n$ for trip units rated 50 A
- $0.20 I_n$ for trip units rated > 50 A

Ground-fault protection can be deactivated by setting the Ig dial to the OFF position.

Ground-fault protection can be reactivated even with the Ig dial in the OFF position:

- By fine-tuning on the keypad
- With EcoStruxure Power Commission software (password-protected)
- By sending a setting command using the communication network (password-protected)

The following three tables specify the setting values (preset by a dial) and setting ranges (set on the keypad):

- For trip units rated 25 A
- For trip units rated 50 A
- For trip units rated > 50 A

On the keypad, the increment is 0.05 x In.

Rating 25 A

Type of setting	Value or setting range (x In)								
Preset by a dial	0.60	0.60	0.60	0.60	0.70	0.80	0.90	1	OFF
Setting range on the keypad	0.60	0.60	0.60	0.60	0.6–0.7	0.6–0.8	0.6–0.9	0.6–1	0.6–1 + OFF

Rating 50 A

Type of setting	Value or setting range (x In)								
Preset by a dial	0.30	0.40	0.50	0.60	0.70	0.80	0.90	1	OFF
Setting range on the keypad	0.30	0.3–0.4	0.3–0.5	0.3–0.6	0.3–0.7	0.3–0.8	0.3–0.9	0.3–1	0.3–1 + OFF

Rating > 50 A

Type of setting	Value or setting range (x In)								
Preset by a dial	0.20	0.30	0.40	0.50	0.60	0.70	0.80	1	OFF
Setting range on the keypad	0.20	0.2–0.3	0.2–0.4	0.2–0.5	0.2–0.6	0.2–0.7	0.2–0.8	0.2–1	0.2–1 + OFF

The accuracy range is +/-10%.

tg Time Delay Setting Values

The tg time delay setting value is in seconds. The hold and breaking times are in milliseconds.



The default tg time delay setting is 0 s.

The following table shows tg setting values in second (s) and the associated hold and breaking times in milliseconds (ms):



Function	Value				
tg (s)	0	0.1	0.2	0.3	0.4
Hold time (ms)	20	80	140	230	350
Maximum breaking time (ms)	80	140	200	320	500

Testing the Ground-Fault Protection

The ground-fault protection can be tested to check the electronic tripping function of the trip unit. Use the keypad of the MicroLogic 6 trip unit to perform this test.

The ground-fault protection test can be performed with the padlock locked  or unlocked .

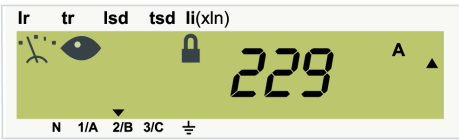
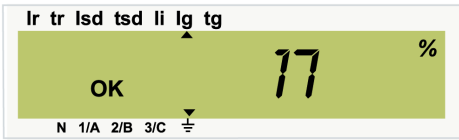
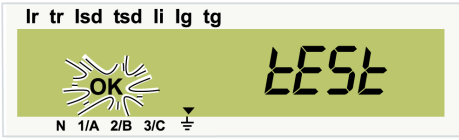
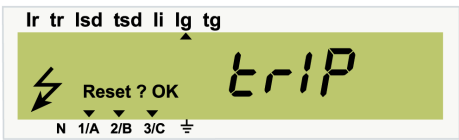
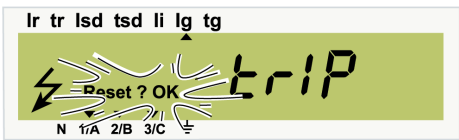
Follow these steps to test and reset the ground-fault protection on MicroLogic 6 trip units.

Step	Action	Display
1	Provide a power supply to the trip unit so that the screen displays the result of the test after the circuit breaker trips.	—
2	Select the Instantaneous measurement readout mode (the display is the most heavily loaded phase, in this example Phase 2).	
3	Select the ground-fault current measurement screen (the value is a percentage of the Ig setting).	
4	Access the ground-fault protection test function by pressing OK . The tEST pictogram appears and the OK pictogram blinks.	
5	Prompt the ground-fault protection test by pressing OK . The circuit breaker trips. The ground-fault protection trip screen is displayed.	
6	Acknowledge the ground-fault trip screen by pressing OK . The Reset? OK pictogram blinks.	
7	Confirm by pressing OK again. The confirmation OK is displayed for 2 s.	

Phase Unbalance Protection

Presentation

Unbalances of the motor phase currents lead to significant heat rise and braking torques that can cause premature deterioration of the motor. These effects are amplified during startup; protection must be almost immediate.

Description

Phase unbalance protection:

- calculates the current unbalance for each phase, compared to the average current, expressed as a percentage:

$$I_{avg} = \frac{(I_1 + I_2 + I_3)}{3}$$

$$I_k \text{ unbalance (\%)} = \frac{I_k - I_{avg}}{I_{avg}} \times 100 \text{ where } k = 1, 2, 3$$

- Compares the value of the maximum current unbalance with the lunbal protection pickup.

The following diagram shows a maximum positive unbalance on phase 2:

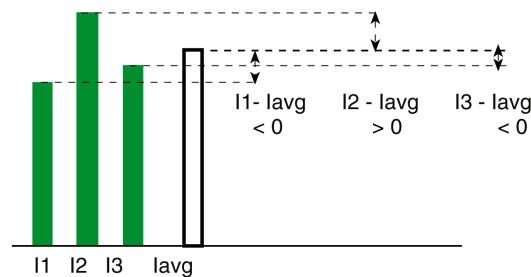

If the maximum current unbalance value is higher than the phase unbalance protection lunbal pickup, the tunbal time delay is actuated.

Phase unbalance protection cannot be deactivated.

Phase unbalance protection is activated during startup and in steady state.

Operating Principle

The following figures illustrate the operating possibilities:

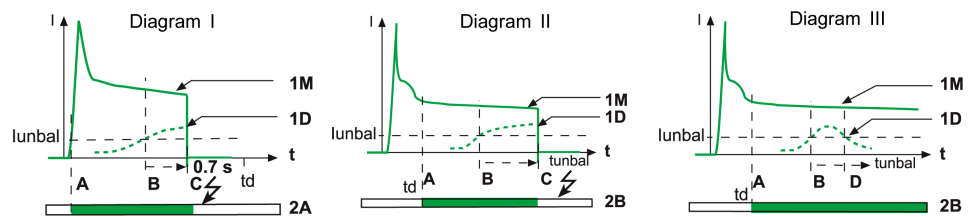

1 M Motor current

1 D Maximum unbalance of the motor phase currents

2 A Monitoring by phase unbalance protection during startup (diagram I)

2 B Monitoring by phase unbalance protection in steady state (diagrams II and III)

White: Not active; Green: Active

- The current unbalance does not fall below the lunbal pickup before the end of the tunbal time delay: the phase unbalance protection trips. The behavior of the protection differs according to the motor operating conditions:
 - During startup (diagram I)
 - A: Activation of startup.
 - B: Activation of protection time delay as soon as the pickup is crossed.
 - C: Protection tripped at the end of the fixed time delay of 0.7 s.
 - In steady state (diagram II)
 - A: Activation of startup.
 - B: Activation of protection time delay as soon as the pickup is crossed.
 - C: Protection tripped at the end of the adjustable time delay.
- The current unbalance falls below the lunbal pickup before the end of the tunbal time delay. The phase unbalance protection does not trip (diagram III):
 - B: Activation of protection time delay as soon as the pickup is crossed.
 - D: Deactivation of protection.

NOTE: The SDTAM module early tripping protection function can be used to command contactor opening, page 86.

Setting the Protection

Set the lunbal pickup and the tunbal time delay:

- With the keypad on the MicroLogic trip unit
- With EcoStruxure Power Commission software (password-protected)
- By sending a setting command using the communication network (password-protected)

lunbal Pickup Setting Value

The lunbal pickup setting value is expressed as a percentage of the average current.

The pickup setting range on the keypad is 10–40%. The increment is 1%. The default pickup setting value is 30%.

The accuracy range is +/-20%.

tunbal Time Delay Setting Value

The tunbal time delay setting value is in seconds.

The tunbal time delay setting depends on the operating conditions:

- During startup, the value of the time delay cannot be adjusted and equals 0.7 s.
- In steady state, the setting range is 1–10 s. The increment is 1 s.
The default time delay setting value is 4 s.

Motor Jam Protection

Presentation

Motor jam protection provides additional protection in order to:

- Detect overtorque.
- Monitor mechanical malfunction.
- Detect malfunctions more quickly on machines for which the motor is oversized.

Examples of machines with a significant risk of jamming: conveyors, crushers and kneaders, fans, pumps and compressors.

Description

Motor jam protection compares the value of the average motor current I_{avg} with the setting value of the protection I_{jam} pickup. If the average motor current I_{avg} exceeds the I_{jam} pickup, the protection t_{jam} time delay is actuated.

By default, motor jam protection is not active.

After function setting, motor jam protection is:

- Active in steady state.
- Disabled during startup.

Operating Principle

The following figures illustrate the operating possibilities:

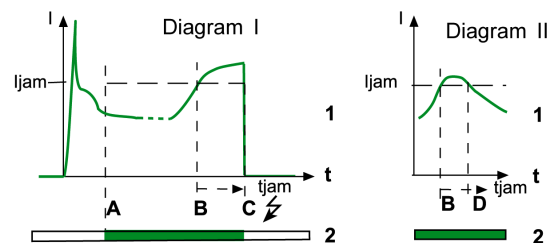

1 Motor current

2 Monitoring by motor jam protection

White: Not active (during startup). Green: Active (steady state)

- Diagram I: The average motor current I_{avg} does not fall back below the protection I_{jam} pickup before the end of the t_{jam} time delay (jammed motor). motor jam protection trips:
 - A: Protection activated (change to steady state).
 - B: Activation of protection time delay as soon as the pickup threshold is crossed.
 - C: Protection tripped at the end of the time delay.
- Diagram II: The average motor current I_{avg} falls back and stays below the protection I_{jam} pickup before the end of the t_{jam} time delay (occasional overload). Motor jam protection does not trip:
 - B: Activation of protection time delay as soon as the pickup threshold is crossed
 - D: Protection disabled.

NOTE: The SDTAM module early tripping protection function can be used to command contactor opening, page 86.

Setting the Protection

Set the I_{jam} pickup and the t_{jam} time delay:

- With the keypad on the MicroLogic trip unit
- With EcoStruxure Power Commission software (password-protected)
- By sending a setting command using the communication network (password-protected)

I_{jam} Pickup Setting Value

The I_{jam} pickup setting value is in multiples of I_r .

The pickup setting range on the keypad is $1-8 \times I_r$. The increment is $0.1 \times I_r$. The default setting value is OFF: protection not active.

The accuracy range is $\pm 10\%$.

t_{jam} Time Delay Setting Value

The t_{jam} time delay setting value is in seconds.

The t_{jam} time delay setting range is $1-30$ s. The increment is 1 s. The default setting value for the time delay is 5 s.

Underload Motor Protection

Presentation

Underload motor protection provides additional protection for detection of motor no-load operation.

Examples of no-load operation: pump running dry, broken drive belt, broken geared motor.

Description

Underload motor protection compares the value of the phase current minimum I_{MIN} with the setting value of the protection lund pickup. If the current value I_{MIN} falls below the lund pickup, the protection tund time delay is actuated.

By default, underload motor protection is not active.

After function setting, underload protection is activated during startup and in steady state.

Operating Principle

The following figures illustrate the operating possibilities:

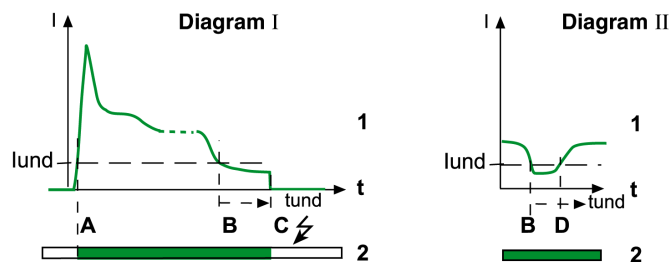

1 Motor current

2 Supervision by underload motor protection

White: Not active; Green: Active

- Diagram I: The phase current minimum value I_{MIN} does not go above the protection lund pickup before the end of the tund time delay (for example, a pump operating at no load). Underload motor protection trips:
 - A: Protection activated (change to steady state)
 - B: Activation of protection time delay as soon as the pickup threshold is crossed
 - C: Protection tripped at the end of the time delay
- Diagram II: The phase current minimum value I_{MIN} goes back and stays above the pickup before the end of the tund time delay (for example, a pump temporarily running dry). The underload motor protection does not trip:
 - B: Activation of protection time delay as soon as the pickup threshold is crossed
 - D: Protection disabled

NOTE: The SDTAM module early tripping protection function can be used to command contactor opening, page 86.

Setting the Protection

The lund pickup and the tund time delay settings can only be accessed:

- With EcoStruxure Power Commission software (password-protected)
- By sending a setting command using the communication network (password-protected)

Iund Pickup Setting Value

The lund pickup setting value is in multiples of I_r .

The pickup setting range is $0.3\text{--}0.9 \times I_r$. The increment is $0.01 \times I_r$. The default setting is OFF: protection not active.

The accuracy range is $\pm 10\%$.

tund Time Delay Setting Value

The tund time delay setting value is in seconds.

The time delay setting range is $1\text{--}200$ s. The increment is 1 s. The default setting value for the time delay is 10 s.

Long-Start Motor Protection

Presentation

Long-start motor protection provides additional protection:

- For machines at risk of difficult starting:
 - High inertia machines
 - High resistive torque machines
 - Machines with fluctuating load from steady state

Examples of machines with a significant risk of difficult starting: fans, compressors.

- To avoid no-load starts:
 - Load not present
 - Machines oversized for the application

Description

Long-start motor protection is activated as soon as the average motor current I_{avg} exceeds 10% of the I_r setting value: the protection long time delay is actuated. Long-start motor protection compares the value of the average motor current I_{avg} with the setting value of the protection I_{long} pickup.

By default, long-start motor protection is not active.

After function setting, long-start motor protection is:

- Active during startup
- Not active in steady state

Operating Principle (Difficult Starting)

On starting, the average motor current I_{avg} overruns the long-start motor protection I_{long} pickup. The protection remains active as long as the average motor current I_{avg} has not fallen below the I_{long} pickup.

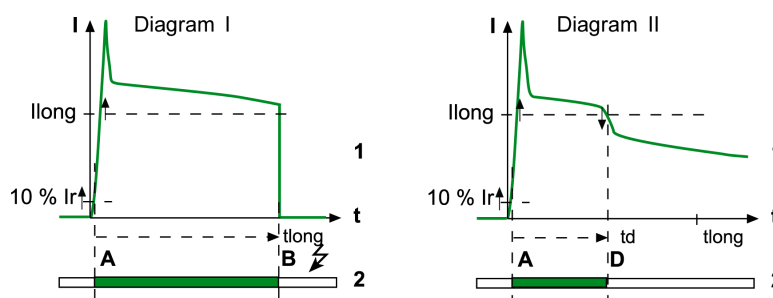

1 Motor current

2 Activation of long-start motor protection tlong time delay

White: Protection not active. Green: Protection active

The curve can evolve in one of two ways:

- Diagram I: The average motor current I_{avg} has not fallen below the I_{long} pickup before the end of the t_{long} time delay (starting with too large a load). Long-start motor protection trips:
 - A: Activation of protection time delay (10% of I_r pickup is exceeded).
 - B: Protection tripped at the end of the time delay.

- Diagram II: The average motor current I_{avg} falls below the I_{long} pickup before the end of the t_{long} time delay (correct starting). Long-start motor protection does not trip:
 - A: Activation of protection time delay (10% of I_r pickup is exceeded).
 - D: Deactivation of protection.

Operating Principle (No-Load Starting)

On starting, the average motor current I_{avg} does not exceed the long-start motor protection I_{long} pickup. The protection remains active as long as the value of the average current I_{avg} has not fallen below 10% of the I_r setting value.

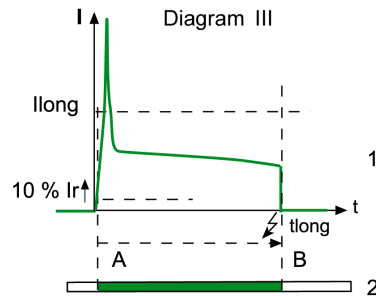

1 Motor current

2 Activation of long-start motor protection time delay

White: Protection not active; Green: Protection active

Diagram III: The motor current has not fallen below 10% of the I_r setting value before the end of the t_{long} time delay: long-start motor protection trips.

- A: Activation of protection time delay (10% of I_r pickup is exceeded)
- B: Protection tripped at the end of the time delay

If the motor current falls back below 10% of the I_r setting value before the end of the protection t_{long} time delay (for example on contactor opening), long-start motor protection does not trip.

NOTE: The MicroLogic trip unit measurement electronics filter the subtransient state (first current peak of approximately 20 ms on contactor closing). This current peak is not therefore taken into account when assessing whether the I_{long} pickup has been crossed.

Setting the Protection

The I_{long} pickup and the t_{long} time delay settings can only be accessed:

- With EcoStruxure Power Commission software (password-protected)
- By sending a setting command using the communication network (password-protected)

I_{long} Pickup Setting Value

The I_{long} pickup setting value is in multiples of I_r .

The pickup setting range is 1–8 x I_r . The increment is 0.1 x I_r . The factory setting is OFF: protection not active.

The accuracy range is +/-10%.

tlong Time Delay Setting Value

The tlong time delay setting value is in seconds.

The tlong time delay setting range is 1–200 s. The increment is 1 s. The factory setting value for the time delay is 10 s.

Metering Function

What's in This Part

Measurement Techniques	107
Measurement Accuracy Tables.....	132

Measurement Techniques

What's in This Chapter

Real-Time Measurements	108
Calculating Demand Values	112
Power Metering	115
Power Calculation Algorithm	118
Energy Metering	121
Harmonic Currents	123
Metering Energy Quality Indicators	126
Power Factor PF and $\cos \phi$ Measurement	128

Real-Time Measurements

Instantaneous Values

MicroLogic trip units:

- Measure the following in real time and as an rms value:
 - Instantaneous current for each phase and the neutral (if present)
 - Ground-fault current (MicroLogic 6 trip unit)
 - Earth-leakage (residual) current (MicroLogic 7 trip unit)
- Calculate the average phase current in real time
- Determine the maximum and minimum values for these electrical quantities (phase, neutral, ground, and residual currents)
- Measure the instantaneous phase-to-phase and phase-to-neutral voltage (if present), in real time and as an rms value
- Calculate the associated electrical quantities from the rms values of the currents and voltages:
 - Average phase-to-phase voltage and phase-to-neutral voltage (if present)
 - Current unbalances
 - Phase-to-phase voltage unbalances and phase-to-neutral voltage unbalances (if present)
 - Powers, page 115
 - Quality indicators: frequency, THD(I) and THD(V), page 126, and power factor PF and $\cos \phi$ measurement, page 128
- Display operating indicators: quadrants, phase rotation, and type of load
- Determine the maximum and minimum values for these electrical quantities
- Increment in real time, three energy meters (active, reactive, apparent) using the total power real-time values, page 115

The sampling method utilizes the values of the harmonic currents and voltages up to the fifteenth order. The sampling period is 512 microseconds.

The values of the electrical quantities, whether measured or calculated in real time, update once a second.

Setting of the Phase Rotation (MicroLogic 5 and 6 Trip Units)

Phase currents are assigned by default to the poles as follows:

- I1: left pole
- I2: middle pole
- I3: right pole

If the phases connected to the poles do not correspond to the default assignment, you can modify the phase rotation setting in MicroLogic 5 and 6 trip units as follows:

- I3: left pole
- I2: middle pole
- I1: right pole

The phase rotation setting can be modified:

- With EcoStruxure Power Commission software (password-protected).
- By sending a setting command using the communication network (password-protected).

NOTE: By default, neutral position is on the left and cannot be changed to the right by using this setting.

Measuring the Neutral Current

MicroLogic 4-pole or 3-pole trip units with the ENCT option measure the neutral current:

- For a 3-pole trip unit, the neutral current is measured by adding a special current transformer on the neutral conductor for the transformer information, refer to LVPED221001EN *ComPacT NSX & NSXm Catalogue*.
- For a 4-pole trip unit, the neutral current is measured systematically.

The neutral current is measured in the same way as the phase currents.

Measuring the Ground-Fault Current

The ground-fault current is calculated using the phase currents, according to the circuit breaker configuration, as shown in the following table.

Circuit breaker configuration	I _g Ground-fault current
3P	$I_g = I_1 + I_2 + I_3$
4P	$I_g = I_1 + I_2 + I_3 + I_N$
3P + ENCT	$I_g = I_1 + I_2 + I_3 + I_N$ (ENCT)

Measuring the Earth-Leakage Current (MicroLogic 7 Trip Unit)

The earth-leakage current is measured by an embedded sensor encompassing the three phases or the three phases and neutral.

Measuring the Phase-to-Neutral Voltages

MicroLogic 4-pole trip units or 3-pole trip units with the ENVT option (MicroLogic 5 and 6 trip units) measure the phase-to-neutral (or line-to-neutral) voltages V_{1N}, V_{2N}, and V_{3N}:

- For a 3-pole trip unit, it is necessary to:
 - Connect the wire from the ENVT option to the neutral conductor.
 - Declare the ENVT option with EcoStruxure Power Commission software (password-protected) or by sending a setting command using the communication network (password-protected).

NOTE: The ENVT option cannot be configured on a MicroLogic 7 trip unit.

- For 4-pole trip units, the phase-to-neutral voltages are measured systematically.

The phase-to-neutral voltages are measured in the same way as the phase-to-phase voltages.

Calculating the Average Current and Average Voltage

MicroLogic trip units calculate the:

- Average current I_{avg} , the arithmetic mean of the 3 phase currents:

$$I_{avg} = (I_1 + I_2 + I_3) / 3$$

- Average voltages:
 - Phase-to-phase V_{avg} , the arithmetic mean of the 3 phase-to-phase voltages:

$$V_{avg} = (V_{12} + V_{23} + V_{31})/3$$

- Phase-to-neutral V_{avg} , the arithmetic mean of the 3 phase-to-neutral voltages (4-pole trip unit or 3-pole trip unit with the ENVV option (MicroLogic 5 or 6 trip unit)):

$$V_{avg} = (V_{1N} + V_{2N} + V_{3N})/3$$

Measuring the Current and Voltage Phase Unbalances

MicroLogic trip units calculate the current unbalance for each phase (3 values).

The current unbalance is a percentage of the average current:

$$I_{avg} = (I_1 + I_2 + I_3)/3$$

$$I_k \text{ unbalance (\%)} = \frac{I_k - I_{avg}}{I_{avg}} \times 100, \text{ where } k = 1, 2, 3$$

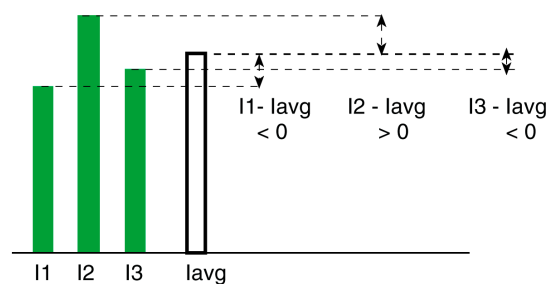

MicroLogic trip units calculate the:

- Phase-to-phase voltage unbalance for each phase (3 values)
- Phase-to-neutral (if present) voltage unbalance for each phase (3 values)

The voltage unbalance is expressed as a percentage compared to the average value of the electrical quantity (V_{avg}):

$$V_{jk} \text{ unbalance (\%)} = \frac{V_{jk} - V_{avg}}{V_{avg}} \times 100 \text{ where } jk = 12, 23, 31$$

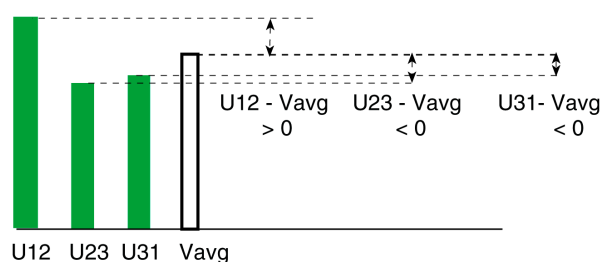

NOTE: The unbalance values are signed (relative values expressed as a percentage). The maximum/minimum unbalance values are absolute values expressed as a percentage.

Maximum/Minimum Values

The MicroLogic trip unit determines in real time the maximum (MAX) and minimum (MIN) value reached by the following electrical quantities organized in groups for the current period:

- Current: Phase, neutral and residual currents, average currents and current unbalances
- Voltage: Phase-to-phase and phase-to-neutral voltages, average voltages, and voltage unbalances
- Power: Total power and power for each phase (active, reactive, apparent, and distortion)
- Total harmonic distortion: the total harmonic distortion THD for both current and voltage
- Frequency
- The maximum values (MAXMAX) of all phase currents and the minimum values (MINMIN) of all phase currents.

The current period for a group starts at the last reset of one of the maximum values in the group (see the following information).

Resetting Maximum/Minimum Values

Reset the maximum and minimum values for a group:

- By sending a reset command using the communication network (password-protected)
- On the FDM121 display (password-protected)

Reset the maximum and minimum values in a group on the keypad using the menu for the following groups:

- Currents
- Voltages
- Powers

Only the maximum values are displayed, but both the maximum and minimum values are reset.

Calculating Demand Values

Presentation

The MicroLogic trip unit calculates:

- The demand values of phase, neutral, and residual currents
- The demand values of the active, reactive, and apparent powers

Each maximum demand value (peak) is stored in memory.

The demand values update according to the type of window.

Definition

The demand value of a quantity is an average value calculated over a defined interval.

The demand value of a quantity can be called the:

- Average/mean value (over an interval)
- Demand
- Demand value (over an interval)

Demand Value Models

The demand value of a quantity over a defined interval (metering window) is calculated according to two different models:

- Arithmetic demand value for the powers
- Quadratic demand value (thermal image) for the currents

Metering Window

The specified time interval T is chosen according to three types of metering windows:

- Fixed window
- Sliding window
- Synchronized window

Fixed Metering Window

The duration of the fixed metering window can be set from 5 to 60 minutes in increments of one minute.

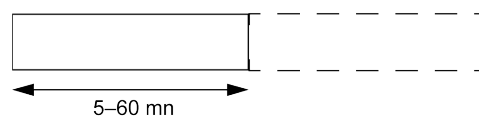

By default, the duration of the fixed metering window is 15 minutes.

At the end of each fixed metering window:

- The demand value over the metering window is calculated and updated.
- Calculation of a new demand value is initialized on a new metering window.

Sliding Metering Window

Set the duration of the sliding metering window from 5 to 60 minutes in increments of one minute.

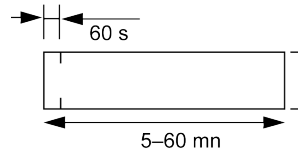

By default, the duration of the sliding metering window is 15 minutes.

At the end of each sliding metering window and then once a minute:

- The demand value over the metering window is calculated and updated.
- Calculation of a new demand value is initialized on a new metering window:
 - By eliminating the contribution of the first minute of the previous metering window
 - By adding the contribution of the current minute

Synchronized Metering Window

Synchronization is done using the communication network.

When the synchronization pulse is received:

- The demand value over the synchronized metering window is recalculated.
- A new demand value is calculated.

NOTE: The interval between two synchronization pulses must be less than 60 minutes.

Quadratic Demand Value (Thermal Image)

The quadratic demand value model represents the conductor heat rise (thermal image).

The heat rise created by the current $I(t)$ over the time interval T is identical to the heat rise created by a constant current I_{th} over the same interval. I_{th} represents the thermal effect of the current $I(t)$ over the interval T . If the period T is infinite, the current I_{th} represents the thermal image of the current.

The demand value according to the thermal model is calculated on a sliding metering window.

NOTE: The thermal demand value is similar to an rms value.

NOTE: Old measuring apparatus naturally display a type of thermal response for calculating demand values.

Arithmetic Demand Value

The arithmetic demand value model represents the consumption of electricity and the associated cost.

The demand value according to the arithmetic model can be calculated on any type of metering window.

Peak Demand Value

The MicroLogic trip unit indicates the maximum value (peak) reached over a defined period for:

- The demand values of the phase, neutral, and residual currents
- The demand values of the active, apparent, and reactive powers

The demand values are organized into two groups:

- Current demand values
- Power demand values

Resetting Peak Demand Values

Reset the peaks in a group:

- By sending a reset command using the communication network (password-protected)
- On the FDM121 display

Power Metering

Presentation

The MicroLogic trip unit calculates the electrical quantities required for power management:

- The instantaneous values of the:
 - Active powers (total P_{tot} and per phase) in kW
 - Reactive powers (total Q_{tot} and per phase) in kVAR
 - Apparent powers (total S_{tot} and per phase) in kVA
 - Fundamental reactive powers (total $Q_{fundtot}$ and per phase) in kVAR
 - Distortion powers (total D_{tot} and per phase) in kVAR
- The maximum and minimum values for each of these powers
- The demand values and the peaks for the total P_{tot} , Q_{tot} , and S_{tot} powers
- The $\cos \phi$ and power factor (PF) indicators
- The operating quadrant and type of load (leading or lagging)

All these electrical quantities are calculated in real time and their value updated once a second.

Principle of Power Metering

The MicroLogic trip unit calculates the power values from the rms values of the currents and voltages.

The calculation principle is based on:

- Definition of the powers
- Algorithms depending on the type of trip unit (4-pole or 3-pole)
- Definition of the power sign (circuit breaker powered from the top or bottom side)

Calculation Algorithm

The calculation algorithm, based on the definition of the powers, is explained in the specific topic, page 118.

Calculations use harmonics up to the fifteenth.

3-Pole Circuit Breaker, 4-Pole Circuit Breaker

The calculation algorithm depends on the presence or absence of voltage metering on the neutral conductor.

4-Pole or 3-pole with ENVT: 3-wattmeter method	3-Pole without ENVT: 2-wattmeter method
<p>When there is voltage metering on the neutral (4-pole or 3-pole circuit breaker with ENVT option), the MicroLogic trip unit measures the power by using three single-phase loads downstream.</p>	<p>When there is no voltage metering on the neutral (3-pole circuit breaker), the MicroLogic trip unit measures the power:</p> <ul style="list-style-type: none"> Using the current from two phases (I1 and I3) and composite voltages from each of these two phases in relation to the third (V12 and V23) Supposing (by definition) that the current in the neutral conductor is zero: $\vec{I}_1 + \vec{I}_2 + \vec{I}_3 = 0$
<p>The calculated power P_{tot} equals:</p> $V_{1N} I_1 \cos(\vec{V}_{1N}, \vec{I}_1) + V_{2N} I_2 \cos(\vec{V}_{2N}, \vec{I}_2) + V_{3N} I_3 \cos(\vec{V}_{3N}, \vec{I}_3)$	<p>To calculate power P_{tot} equals PW1 + PW2:</p> $V_{12} I_1 \cos(\vec{V}_{12}, \vec{I}_1) + V_{32} I_3 \cos(\vec{V}_{32}, \vec{I}_3)$

The following table lists the metering options:

Method	3-Pole circuit breaker, non-distributed neutral	3-Pole circuit breaker, distributed neutral	3-Pole circuit breaker, distributed neutral with ENVT option	4-Pole circuit breaker
2 wattmeters	✓	✓ ⁽¹⁾	–	–
3 wattmeters	–	–	✓	✓

(1) The measurement is incorrect once there is current circulating in the neutral.

3-Pole Circuit Breaker, Distributed Neutral

To activate the ENVT option on a 3-pole circuit breaker with distributed neutral, it is necessary to:

- Connect the wire from the ENVT option to the neutral conductor.
- Declare the ENVT option with EcoStruxure Power Commission software (password-protected) or by sending a setting command using the communication network (password-protected).

NOTE: Declaration of the ENCT option alone does not result in correct calculation of the powers. It is essential to connect the wire from the ENVT to the neutral conductor.

Power Sign and Operating Quadrant

By definition, the active powers are:

- Signed + when they are consumed by the user, that is, when the device is acting as a receiver.
- Signed - when they are supplied by the user, that is, when the device is acting as a generator.

By definition, the reactive powers are:

- Have the same sign as the active energies and powers when the current lags behind the voltage, that is, when the device is inductive (lagging).
- Have the opposite sign to the active energies and powers when the current is ahead of the voltage, that is, when the device is capacitive (leading).

These definitions therefore determine four operating quadrants (Q1, Q2, Q3, and Q4):

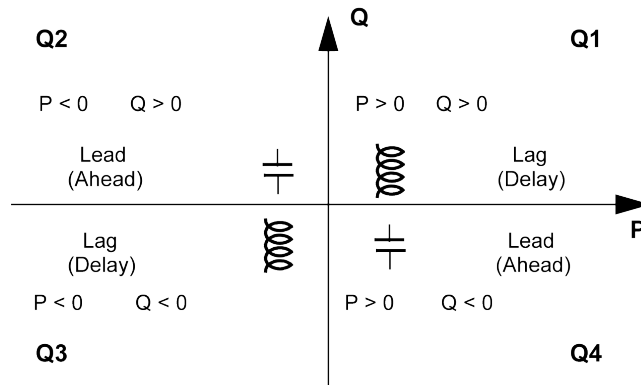

NOTE: The power values are:

- Signed on the communication (for example, when reading the FDM121 display).
- Not signed when reading the MicroLogic LCD display.

Top or Bottom-Side Connection to the Power Supply

ComPacT NSX circuit breakers can be connected to the power supply from the top (standard, considered to be the default position) or from the bottom side: the sign for the power running through the circuit breaker depends on the type of connection.

NOTE: By default, the MicroLogic trip unit signs as positive the powers running through the circuit breaker supplied from the top with loads connected from the bottom side.

Circuit breakers powered from the bottom side must have the powers signed as negative.

Modify the **Power** sign parameter:

- With EcoStruxure Power Commission software (password-protected)
- By sending a setting command using the communication network (password-protected)

Power Calculation Algorithm

Presentation

The algorithms are given for both calculation methods (2 wattmeters and 3 wattmeters). The power definitions and calculation are given for a network with harmonics.

The MicroLogic trip unit displays all the calculated quantities as follows:

- On the MicroLogic trip unit display screen, page 43
- Using the communication network
- On the FDM121 display

With the 2-wattmeter calculation method, it is not possible to deliver power metering for each phase.

Input Data

The input data are the voltages and currents for each phase. For more information about calculating harmonics, see harmonic currents, page 123.

$$\begin{aligned}
 v_{ij}(t) &= \sum_{n=1}^{15} V_{ijn} \sqrt{2} \sin(n\omega t) & \text{and} & & V_{ij} &= \sqrt{\sum_{n=1}^{15} V_{ijn}^2} \\
 v_{iN}(t) &= \sum_{n=1}^{15} V_{iNn} \sqrt{2} \sin(n\omega t) & \text{and} & & V_i &= \sqrt{\sum_{n=1}^{15} V_{in}^2} \quad \text{(3-pole or 4-pole trip unit with ENVT option)} \\
 i_i(t) &= \sum_{n=1}^{15} I_{in} \sqrt{2} \sin(n\omega t - \varphi_n) & \text{and} & & I_i &= \sqrt{\sum_{n=1}^{15} I_{in}^2} \\
 \text{where } & i, j = 1, 2, 3 \text{ (phase)}
 \end{aligned}$$

Using this data, the MicroLogic trip unit calculates the various power ratings according to the sequence described below.

Active Powers

Metering on a 3-pole or 4-pole circuit breaker with ENVT option	Metering on a 3-pole circuit breaker without ENVT option
The active power for each phase and total active power is calculated.	Only the total active power can be calculated.
$P_i = \frac{1}{T} \int_T v_i(t) i_i(t) dt = \sum_{n=1}^{15} V_{in} I_{in} \cos(\varphi_{in})$ where $i = 1, 2, 3$ (phase)	–
$P_{tot} = P_1 + P_2 + P_3$	$P_{tot} = P_{w1} + P_{w2}$

P_{w1} and P_{w2} are the fictional powers calculated by the 2-wattmeter method.

Apparent Powers for Each Phase

Metering on a 3-pole or 4-pole circuit breaker with ENVT option	Metering on a 3-pole circuit breaker without ENVT option
The apparent power is calculated for each phase.	–
$S_i = (V_i \cdot I_i)$ where $i = 1, 2, 3$ (phase)	–

Reactive Powers With Harmonics for Each Phase

Reactive power with harmonics is not physically significant.

Metering on a 3-pole or 4-pole circuit breaker with ENVT option	Metering on a 3-pole circuit breaker without ENVT option
The reactive power with harmonics is calculated for each phase.	–
$Q_i = \sqrt{S_i^2 - P_i^2}$ where $i = 1, 2, 3$ (phase)	–

Reactive Powers

The reactive power of the fundamental corresponds to the physical reactive power.

Metering on a 3-pole or 4-pole circuit breaker with ENVT option	Metering on a 3-pole circuit breaker without ENVT option
The reactive power for each phase and total reactive power is calculated.	Only the total reactive power can be calculated.
$Q_{fund_i} = V_{1i} I_{1i} \sin \varphi_1$ where $i = 1, 2, 3$ (phase)	–
$Q_{fundtot} = Q_{fund_1} + Q_{fund_2} + Q_{fund_3}$	$Q_{fundtot} = Q_{fundw1} + Q_{fundw2}$

Q_{fundw1} and Q_{fundw2} are the fictional reactive powers calculated by the 2-wattmeter method.

Distortion Power

Distortion power is the quadratic difference between the reactive power with harmonics and the reactive power (fundamental).

Metering on a 3-pole or 4-pole circuit breaker with ENVT option	Metering on a 3-pole circuit breaker without ENVT option
The distortion power for each phase and the total distortion power is calculated.	Only the total distortion power can be calculated.
$D_i = \sqrt{Q_i^2 - Q_{fund_i}^2}$ where $i = 1, 2, 3$ (phase)	–
$D_{tot} = D_1 + D_2 + D_3$	$D_{tot} = D_{w1} + D_{w2}$

D_{w1} and D_{w2} are the fictional powers calculated by the 2-wattmeter method.

Total Reactive Power (With Harmonics)

The total reactive power (with harmonics) is not physically significant.

Metering on a 3-pole or 4-pole circuit breaker with ENVT option	Metering on a 3-pole circuit breaker without ENVT option
The total reactive power is calculated.	The total reactive power is calculated.
$Q_{tot} = \sqrt{Q_{fund_{tot}}^2 + D_{tot}^2}$	$Q_{tot} = \sqrt{Q_{fund_{tot}}^2 + D_{tot}^2}$

Total Apparent Power

Metering on a 3-pole or 4-pole circuit breaker with ENVT option	Metering on a 3-pole circuit breaker without ENVT option
The total apparent power is calculated.	The total apparent power is calculated.
$S_{tot} = \sqrt{P_{tot}^2 + Q_{tot}^2}$	$S_{tot} = \sqrt{P_{tot}^2 + Q_{tot}^2}$

Energy Metering

Presentation

The MicroLogic trip unit calculates the different types of energy using energy meters and provides the values of:

- The active energy E_p , the active energy supplied E_{pOut} , and the active energy consumed E_{pIn}
- The reactive energy E_q , the reactive energy supplied E_{qOut} , and the reactive energy consumed E_{qIn}
- The apparent energy E_s

The energy values are shown as an hourly consumption. Values update once a second. Values are stored in non-volatile memory once an hour.

NOTE: When the current through the circuit breaker is too low (15–50 A, depending on the rating), the MicroLogic trip unit must be powered with an external 24 Vdc power supply in order to calculate energy. Refer to MicroLogic trip unit power supply, page 24.

Principle of Energy Calculation

By definition

- Energy is the integration of the instantaneous power over a period T:

$$E = \int_T G \delta t \quad \text{where } G = P, Q \text{ or } S$$

- The value of the instantaneous active power P and the reactive power Q can be positive (power consumed) or negative (power supplied) according to the operating quadrant, page 116.
- The value of the apparent power S is always counted positively.

Partial Energy Meters

For each type of energy, active or reactive, a partial energy consumed meter and a partial energy supplied meter calculate the accumulated energy by incrementing once a second:

- The contribution of the instantaneous power consumed for the energy consumed meter

$$E(t)_{In} (\text{consumed}) = \left(\sum_{t-1} G_{in}(u) + G_{in} \right) / 3600 \quad \text{where } G_{in} = P_{tot} \text{ or } Q_{tot} \text{ consumed}$$

- The contribution as an absolute value of the power supplied for the energy supplied meter (power supplied is always counted negatively)

$$E(t)_{Out} (\text{supplied}) = \left(\left| \sum_{t-1} G_{out}(u) + G_{out} \right| \right) / 3600 \quad \text{where } G_{out} = P_{tot} \text{ or } Q_{tot} \text{ supplied}$$

The calculation is initialized by the last reset action.

Energy Meters

From the partial energy meters and for each type of energy, active or reactive, an energy meter provides either of the following measurements once a second:

- The absolute energy, by adding the consumed and supplied energies together. The energy accumulation mode is absolute.

$$E(t)_{\text{absolute}} = E(t)_{\text{In}} + E(t)_{\text{Out}}$$

- The signed energy, by differentiating between consumed and supplied energies. The energy accumulation mode is signed.

$$E(t)_{\text{signed}} = E(t)_{\text{In}} - E(t)_{\text{Out}}$$

The apparent energy E_s is always counted positively.

Selecting Energy Calculation

The information sought determines calculation selection:

- The absolute value of the energy that has crossed the poles of a circuit breaker or the cables of an item of electrical equipment is relevant for maintenance of an installation.
- The signed values of the energy supplied and the energy consumed are required to calculate the economic cost of an item of equipment.

By default, absolute energy accumulation mode is configured.

The setting can be modified:

- With EcoStruxure Power Commission software (password-protected)
- By sending a setting command using the communication network (password-protected)

Resetting Energy Meters

Reset the energy meters using:

- The communication network (password-protected)
- The FDM121 display
- An input of the IO module

There are two additional active energy accumulation meters (E_{pIn} and E_{pOut}) that cannot be reset.

Harmonic Currents

Origin and Effects of Harmonics

Many nonlinear loads present on an electrical network creates a high level of harmonic currents in the electrical networks.

These harmonic currents:

- Distort the current and voltage waves
- Degrade the quality of the distributed energy

These distortions, if they are significant, can result in:

- Malfunctions or degraded operation in the powered devices
- Unwanted heat rises in the devices and conductors
- Excessive power consumption

These various problems increase the system installation and operating costs. It is therefore necessary to control the energy quality carefully.

Definition of a Harmonic

A periodic signal is a superimposition of:

- The original sinusoidal signal at the fundamental frequency (for example, 50 Hz or 60 Hz)
- Sinusoidal signals whose frequencies are multiples of the fundamental frequency called harmonics
- Any DC component

This periodic signal is broken down into a sum of terms:

$$y(t) = y_0 + \sum_{n=1}^{\infty} y_n (\sqrt{2} \times \sin(n\omega t - \phi_n))$$

where:

- y_0 : Value of the DC component
- y_n : rms value of the nth harmonic
- ω : Pulsing of the fundamental frequency
- ϕ_n : Phase displacement of harmonic component n

NOTE: The DC component is usually very low (even upstream of rectifier bridges) and can be deemed to be zero.

NOTE: The first harmonic is called the fundamental (original signal).

Example of a current wave distorted by a harmonic component:

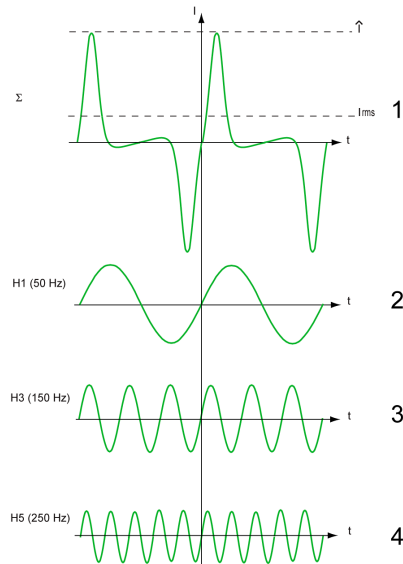

1 I_{rms} : rms value of the total current

2 I_1 : Fundamental current

3 I_3 : Third order harmonic current

4 I_5 : Fifth order harmonic current

RMS Currents and Voltages

MicroLogic trip units display the rms values of currents and voltages.

- The total rms current I_{rms} is the square root of the sum of the square of the rms currents of each harmonic:

$$I_{rms} = \sqrt{\sum_{n=1}^{\infty} I_{nrms}^2} = \sqrt{I_{1rms}^2 + I_{2rms}^2 + \dots + I_{nrms}^2 + \dots}$$

- The total rms voltage V_{rms} is the square root of the sum of the square of the rms voltages of each harmonic:

$$V_{rms} = \sqrt{\sum_{n=1}^{\infty} V_{nrms}^2} = \sqrt{V_{1rms}^2 + V_{2rms}^2 + \dots + V_{nrms}^2 + \dots}$$

Acceptable Harmonic Levels

Various standards and statutory regulations set the acceptable harmonic levels:

- Electromagnetic compatibility standard adapted to low voltage public networks: IEC/EN 61000-2-2
- Electromagnetic compatibility standards:
 - For loads below 16 A: IEC/EN 61000-3-2
 - For loads higher than 16 A: IEC/EN 61000-3-4
- Recommendations from energy distribution companies applicable to the installations

The results of international studies have identified typical harmonic values that should not be exceeded.

The following table lists the typical harmonic values for voltage as a percentage of the fundamental:

Odd harmonics that are not multiples of 3		Odd harmonics that are multiples of 3		Even harmonics	
Order (n)	Value as a % of V_1	Order (n)	Value as a % of V_1	Order (n)	Value as a % of V_1
5	6%	3	5%	2	2%
7	5%	9	1.5%	4	1%
11	3.5%	15	0.3%	6	0.5%
13	3%	>15	0.2%	8	0.5%
17	2%	–	–	10	0.5%
>19	1.5%	–	–	>10	0.2%

NOTE: Harmonics of a high order ($n > 15$) have very low rms values and can therefore be ignored.

Metering Energy Quality Indicators

Presentation

The MicroLogic trip unit provides, using the communication network, the measurements and quality indicators required for energy management:

- Reactive power measurement
- Power factor PF
- $\cos \phi$
- Total harmonic distortion THD
- Distortion power measurement

The energy quality indicators consider:

- Reactive energy management ($\cos \phi$ metering) to optimize the size of the equipment or avoid peak tariffs.
- Management of harmonics to avoid degradation and malfunctions during operation.

Use these measurements and indicators to implement corrective actions to maintain energy quality.

Current THD

The current THD is defined by standard IEC/EN 61000-2-2.

The current THD is a percentage of the rms value of harmonic currents greater than 1 in relation to the rms value of the fundamental current (order 1). The MicroLogic trip unit calculates the total harmonic current distortion THD up to the fifteenth harmonic:

$$\text{THD}(I) = \frac{\sqrt{\sum_{n=2}^{15} I_{n\text{rms}}^2}}{I_{1\text{rms}}} = \sqrt{\left(\frac{I_{\text{rms}}}{I_{1\text{rms}}}\right)^2 - 1}$$

The current THD can be higher than 100%.

Use the total harmonic distortion THD(I) to assess the deformation of the current wave with a single number. The following table shows the THD limit values.

THD(I) value	Comments
THD(I) < 10%	Low harmonic currents: little risk of malfunctions.
10% < THD(I) < 50%	Significant harmonic currents: risk of heat rise, oversizing of supplies.
50% < THD(I)	High harmonic currents: the risks of malfunction, degradation, and dangerous heat rise are almost certain unless the installation is calculated and sized with this restriction in mind.

Deformation of the current wave created by a nonlinear device with a high THD(I) can lead to deformation of the voltage wave, depending on the level of distortion and the source impedance. This deformation of the voltage wave affects all of the devices powered by the supply. Sensitive devices on the system can therefore be affected. A device with a high THD(I) may not be affected itself but could cause malfunctions on other, more sensitive devices on the system.

NOTE: THD(I) metering is an effective way of determining the potential for problems from the devices on electrical networks.

Voltage THD

The voltage THD is defined by standard IEC/EN 61000-2-2.

The voltage THD is the percentage the rms value of harmonic voltages greater than 1 in relation to the rms value of the fundamental voltage (first order). The MicroLogic trip unit calculates the voltage THD up to the fifteenth harmonic:

$$THD(V) = \frac{\sqrt{\sum_{n=2}^{15} V_{n\text{rms}}^2}}{V_{1\text{rms}}}$$

This factor can in theory be higher than 100% but is in practice rarely higher than 15%.

Use the total harmonic distortion THD(V) to assess the deformation of the voltage wave with a single number. The following limit values are commonly evaluated by energy distribution companies:

THD(V) value	Comments
THD(V) < 5%	Insignificant deformation of the voltage wave: little risk of malfunctions.
5% < THD(V) < 8%	Significant deformation of the voltage wave: risk of heat rise and malfunctions.
8% < THD(V)	Significant deformation of the voltage wave: there is a high risk of malfunction unless the installation is calculated and sized based on this deformation.

Deformation of the voltage wave affects all devices powered by the supply.

NOTE: Use the THD(V) indication to assess the risks of disturbance of sensitive devices supplied with power.

Distortion Power D

When harmonic pollution is present, calculation of the total apparent power involves 3 terms:

$$S_{tot}^2 = P_{tot}^2 + Q_{tot}^2 + D_{tot}^2$$

The distortion power D qualifies the energy loss due to the presence of harmonic pollution.

Power Factor PF and $\cos \phi$ Measurement

Power Factor PF

The MicroLogic trip unit calculates the power factor PF from the total active power P_{tot} and the total apparent power S_{tot} :

$$PF = \frac{P_{tot}}{S_{tot}}$$

This indicator qualifies:

- The oversizing necessary for the installation power supply when harmonic currents are present
- The presence of harmonic currents by comparison with the value of the $\cos \phi$.

$\cos \phi$

The MicroLogic trip unit calculates the $\cos \phi$ from the total active power $P_{fundtot}$ and the total apparent power $S_{fundtot}$ of the fundamental (first order):

$$\cos \phi = \frac{P_{fundtot}}{S_{fundtot}}$$

This indicator qualifies use of the energy supplied.

Power Factor PF and $\cos \phi$ when Harmonic Currents are Present

If the supply voltage is not too distorted, the power factor PF is expressed as a function of the $\cos \phi$ and the THD(I) by:

$$PF \approx \frac{\cos \phi}{\sqrt{1 + THD(I)^2}}$$

The following graph specifies the value of PF/ $\cos \phi$ as a function of the THD(I):

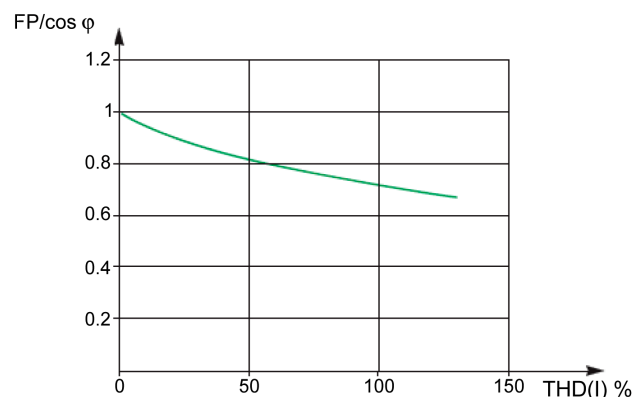

By comparing the two values, it is possible to estimate the level of harmonic deformation on the supply.

Sign for the Power Factor PF and $\cos \phi$

Two sign conventions can be applied for these indicators:

- IEC convention: The sign for these indicators complies strictly with the signed calculations of the powers (that is, P_{tot}, S_{tot}, P_{fundtot}, and S_{fundtot}).
- IEEE convention: The indicators are calculated in accordance with the IEC convention but multiplied by the inverse of the sign for the reactive power (Q).

$$PF = \frac{P_{tot}}{S_{tot}} \times (-\text{sign}(Q)) \quad \text{and} \quad \cos \phi = \frac{P_{fundtot}}{S_{fundtot}} \times (-\text{sign}(Q))$$

The following figures define the sign for the power factor PF and cos φ by quadrant (Q1, Q2, Q3 and Q4) for both conventions:

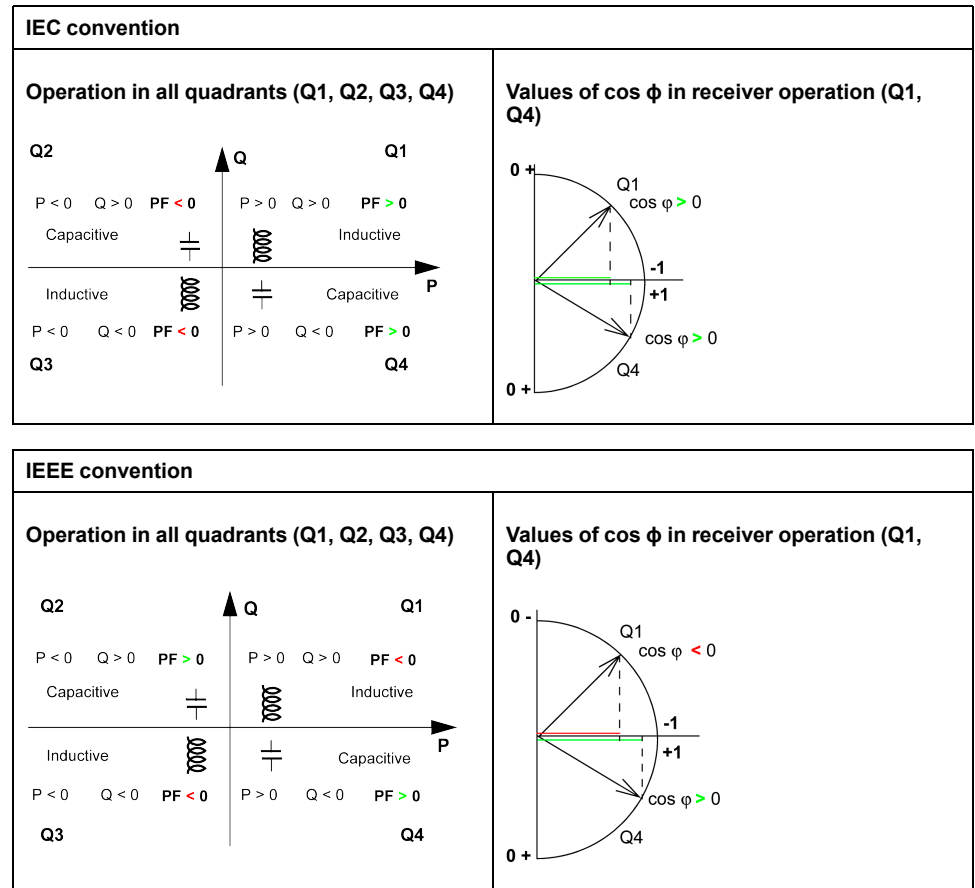

NOTE: For a device, a part of an installation which is only a receiver (or generator), the advantage of the IEEE convention is that it adds the type of reactive component to the PF and cos φ indicators:

- Lead: positive sign for the PF and cos φ indicators
- Lag: negative sign for the PF and cos φ indicators

Managing the Power Factor PF and cos φ: Minimum and Maximum Values

Managing the PF and cos φ indicators consists of:

- Defining critical situations
- Implementing monitoring of the indicators in accordance with the definition of critical situations

Situations are considered critical when the values of the indicators are around 0. The minimum and maximum values of the indicators are defined for these situations.

The following figure illustrates the variations of the $\cos \phi$ indicator (with the definition of the $\cos \phi$ MIN/MAX) and its value according to IEEE convention for a receiver application:

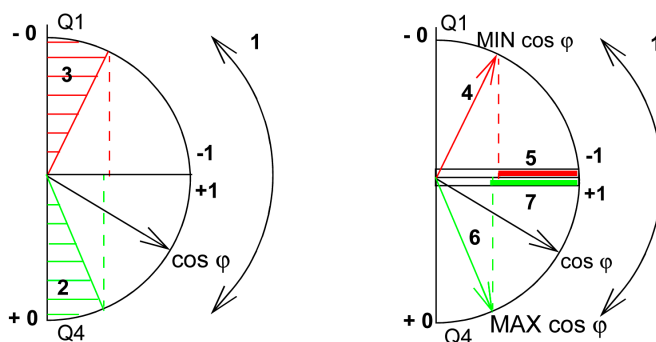

- 1 Arrows indicating the $\cos \phi$ variation range for the load in operation
- 2 Critical zone + 0 for highly capacitive devices (shaded green)
- 3 Critical zone - 0 for highly inductive devices (shaded red)
- 4 Minimum position of the load $\cos \phi$ (lagging): red arrow
- 5 Variation range of the value of the load $\cos \phi$ (lagging): red
- 6 Maximum position of the load $\cos \phi$ (leading): green arrow
- 7 Variation range of the value of the load $\cos \phi$ (leading): green

PF MAX (or $\cos \phi$ MAX) is obtained for the smallest positive value of the PF (or $\cos \phi$) indicator.

PF MIN (or $\cos \phi$ MIN) is obtained for the largest negative value of the PF (or $\cos \phi$) indicator.

NOTE: The minimum and maximum values of the PF and $\cos \phi$ indicators are not physically significant: they are markers which determine the ideal operating zone for the load.

Monitoring the $\cos \phi$ and Power Factor PF Indicators

According to the IEEE convention, critical situations in receiver mode on a capacitive or inductive load are detected and differentiated (two values).



The following table indicates the direction in which the indicators vary and their value in receiver mode.

IEEE convention		
Operating quadrant	Q1	Q4
Direction in which the $\cos \phi$ (or PFs) vary over the operating range		
Value of the $\cos \phi$ (or PFs) over the operating range	0...-0.3...-0.8...-1	+1...+0.8...+0.4...0

The quality indicator MAX and MIN indicate both critical situations.

According to the IEC convention, critical situations in receiver mode on a capacitive or inductive load are detected but not differentiated (one value).

The following table indicates the direction in which the indicators vary and their value in receiver mode.

IEC convention		
Operating quadrant	Q1	Q4
Direction in which the $\cos \phi$ (or PFs) vary over the operating range		
Value of the $\cos \phi$ (or PFs) over the operating range	0...+0.3...+0.8...+1	+1...+0.8...+0.4...0

The quality indicator MAX indicates both critical situations.

Selecting the Sign Convention for the $\cos \phi$ and Power Factor PF

Set the sign convention for the $\cos \phi$ and PF indicators:

- With EcoStruxure Power Commission software (password-protected)
- By sending a setting command using the communication network (password-protected)

The IEEE convention is applied by default.

NOTE: The sign convention selection also determines the alarm selection. For example, monitoring of an alarm indicator which uses IEC convention is incorrect if the IEEE convention has been configured.

Measurement Accuracy Tables

What's in This Chapter

Measurement Accuracy	133
Real-Time Measurements	134
Demand Value Measurements	138
Energy Metering	139

Measurement Accuracy

Presentation

MicroLogic trip units provide measurements available:

- Using the communication network
- On the FDM121 display in the **Services** or **Metering** menu.

The measurements indicated in the following list can be accessed on the MicroLogic trip unit display, page 43.

The tables in this chapter indicate the measurements available and specify the following information for each measurement:

- Unit
- Measurement range
- Accuracy
- Accuracy range

Measurement Accuracy

The trip units comply with the requirements of standard IEC/EN 61557-12 in accordance with:

- Class 1, for current metering
- Class 2, for energy metering

The accuracy of each measurement is defined:

- For a MicroLogic trip unit powered in normal conditions
- At a temperature of 23 °C +/-2 °C (73 °F +/-3 °F).

For a measurement taken at a different temperature, in the temperature range -25 °C to +70 °C (-13 °F to +158 °F), the derating coefficient for temperature accuracy is 0.05% per degree.

The accuracy range is the part of the measurement range for which the defined accuracy is obtained; the definition of this range can be linked to the circuit breaker load characteristics.

Real-Time Measurements

Current Metering

Measurement	Unit	Measurement range	Accuracy	Accuracy range
<ul style="list-style-type: none"> Phase I1, I2, I3, and neutral IN current measurements ⁽¹⁾ Maximum current values of phases I1 MAX, I2 MAX, I3 MAX, and the neutral IN MAX ⁽¹⁾ Maximum value (MAX) of all phase currents Minimum current values of phases I1 MIN, I2 MIN, I3 MIN and neutral IN MIN ⁽¹⁾ Minimum value (MINMIN) of all phase currents Average current Iavg measurements Maximum average current value Iavg MAX Minimum average current value Iavg MIN 	A	0–20 In	+/-1%	0.2–1.2 In
MicroLogic 6 trip unit <ul style="list-style-type: none"> Ground-fault current measurement Maximum/minimum value of the ground-fault current 	% Ig	0–600%	–	–
MicroLogic 7 trip unit <ul style="list-style-type: none"> Earth-leakage current measurement Maximum/minimum value of the earth-leakage current 	A	0–100	–	–
(1) IN with 4-pole or 3-pole trip unit with ENCT option				

Current Unbalance Metering

The accuracy range is for the current range: 0.2–1.2 In.

Measurement	Unit	Measurement range	Accuracy	Accuracy range
<ul style="list-style-type: none"> Current phase unbalance measurements I1 unbal, I2 unbal, I3 unbal Maximum values of current phase unbalances I1 unbal MAX, I2 unbal MAX, I3 unbal MAX Maximum value (MAXMAX) of all phase unbalances 	% Iavg	-100–100%	+/-2%	-100–100%

NOTE:

- The unbalance values are signed (relative values).
- The unbalance maximum values (MAX) are not signed (absolute values).

Voltage Metering

Measurement	Unit	Measurement range	Accuracy	Accuracy range
<ul style="list-style-type: none"> Phase-to-phase V12, V23, V31 and phase-to-neutral V1N, V2N, V3N voltage measurements ⁽¹⁾ Maximum values of phase-to-phase voltages V12 MAX L-L, V23 MAX L-L, V31 MAX L-L and phase-to-neutral voltages V1N MAX L-N, V2N MAX L-N, V3N MAX L-N ⁽¹⁾ Maximum value of the MAX phase-to-phase voltages (V12, V23, V31) Minimum values of phase-to-phase voltages V12 MIN L-L, V23 MIN L-L, V31 MIN L-L and phase-to-neutral voltages V1N MIN L-N, V2N MIN L-N, V3N MIN L-N ⁽¹⁾ Minimum value of the minimum phase-to-phase voltages (V12, V23, V31) Average voltage measurements Vavg L-L and Vavg L-N Maximum value of average voltages Vavg MAX L-L and Vavg MAX L-N Minimum value of average voltages Vavg MIN L-L and Vavg MIN L-N 	V	0–850	+/-0.5%	70–850
(1) V1N, V2N, V3N with 4-pole or 3-pole trip unit with ENVT option				

Voltage Unbalance Metering

The accuracy range is for the voltage range: 70–850 V.

Measurement	Unit	Measurement range	Accuracy	Accuracy range
<ul style="list-style-type: none"> Phase-to-phase voltage V12unbal L-L, V23unbal L-L, V31unbal L-L and phase-to-neutral voltage V1Nunbal L-N, V2Nunbal L-N, V3Nunbal L-N unbalance measurements ⁽¹⁾ Maximum values of phase-to-phase voltage unbalances V12unbal MAX L-L, V23unbal MAX L-L, V31unbal MAX L-L and phase-to-neutral voltage unbalances V1Nunbal MAX L-L, V2Nunbal MAX L-L, V3Nunbal MAX L-L ⁽¹⁾ Maximum values (MAXMAX) of the MAX of the phase-to-phase and phase-to-neutral voltage unbalances ⁽¹⁾ 	% Vavg L-L % Vavg L-N	-100–100%	+/-1%	-100–100%
(1) V1N, V2N, V3N with 4-pole or 3-pole trip unit with ENVT option				

NOTE:

- The unbalance values are signed (relative values).
- The unbalance maximum values (MAX) are not signed (absolute values).

Power Metering

The accuracy range is for:

- current range: 0.1–1.2 In
- voltage range: 70–850 V
- cos φ range: from -1 to -0.5 and from 0.5 to 1

Measurement	Unit	Measurement range	Accuracy	Accuracy range
Only with 4-pole or 3-pole trip unit with ENVT option <ul style="list-style-type: none"> Active power measurements for each phase P1, P2, P3 Maximum values of active powers for each phase P1 MAX, P2 MAX, P3 MAX Minimum values of active powers for each phase P1 MIN, P2 MIN, P3 MIN 	kW	-1000 to 1000	+/-2%	-1000 to -1 1 to 1000
<ul style="list-style-type: none"> Total active power measurement Ptot 	kW	-300 to 3000	+/-2%	-3000 to -3

Measurement	Unit	Measurement range	Accuracy	Accuracy range
<ul style="list-style-type: none"> Maximum value of total active power P_{tot} MAX Minimum value of total active power P_{tot} MIN 				3 to 3000
Only with 4-pole or 3-pole trip unit with ENVT option <ul style="list-style-type: none"> Reactive power measurements for each phase Q1, Q2, Q3 Maximum values of reactive powers for each phase Q1 MAX, Q2 MAX, Q3 MAX Minimum values of reactive powers for each phase Q1 MIN, Q2 MIN, Q3 MIN 	kVAR	-1000 to 1000	+/-2%	-1000 to -1 1 to 1000
<ul style="list-style-type: none"> Total reactive power measurement Q_{tot} Maximum value of total reactive power Q_{tot} MAX Minimum value of total reactive power Q_{tot} MIN 	kVAR	-3000 to 3000	+/-2%	-3000 to -3 3 to 3000
Only with 4-pole or 3-pole trip unit with ENVT option <ul style="list-style-type: none"> Apparent power measurements for each phase S1, S2, S3 Maximum values of apparent powers for each phase S1 MAX, S2 MAX, S3 MAX Minimum values of apparent powers for each phase S1 MIN, S2 MIN, S3 MIN 	kVA	-1000 to 1000	+/-2%	-1000 to -1 1 to 1000
<ul style="list-style-type: none"> Total apparent power measurement S_{tot} Maximum value of total apparent power S_{tot} MAX Minimum value of total apparent power S_{tot} MIN 	kVA	-3000 to 3000	+/-2%	-3000 to -3 3 to 3000
Only with 4-pole or 3-pole trip unit with ENVT option <ul style="list-style-type: none"> Fundamental reactive power measurements for each phase Q_{fund} 1, Q_{fund} 2, Q_{fund} 3 Maximum values of fundamental reactive powers for each phase Q_{fund} 1 MAX, Q_{fund} 2 MAX, Q_{fund} 3 MAX Minimum values of fundamental reactive powers for each phase Q_{fund} 1 MIN, Q_{fund} 2 MIN, Q_{fund} 3 MIN 	kVAR	-1000 to 1000	+/-2%	-1000 to -1 1 to 1000
<ul style="list-style-type: none"> Total fundamental reactive power measurement Q_{fundtot} Maximum value of total fundamental reactive power Q_{fundtot} MAX Minimum value of total fundamental reactive power Q_{fundtot} MIN 	kVAR	-3000 to 3000	+/-2%	-3000 to -3 3 to 3000
Only with 4-pole or 3-pole trip unit with ENVT option <ul style="list-style-type: none"> Distorting power measurements for each phase D1, D2, D3 Maximum values of distorting powers for each phase D1 MAX, D2 MAX, D3 MAX Minimum values of distorting powers for each phase D1 MIN, D2 MIN, D3 MIN 	kVAR	-1000 to 1000	+/-2%	-1000 to -1 1 to 1000
<ul style="list-style-type: none"> Total distorting power measurement D_{tot} Maximum value of total distorting power D_{tot} MAX Minimum value of total distorting power D_{tot} MIN 	kVAR	-3000 to 3000	+/-2%	-3000 to -3 3 to 3000

Operating Indicators

Measurement	Unit	Measurement range	Accuracy	Accuracy range
Operating quadrant measurement	–	1, 2, 3, 4	–	–
Direction of phase rotation measurement	–	0, 1	–	–
Type of load measurement (leading/lagging)	–	0, 1	–	–

Energy Quality Indicators

The accuracy range is for:

- current range: 0.1–1.2 I_n
- voltage range: 70–850 V

Measurement	Unit	Measurement range	Accuracy	Accuracy range
<ul style="list-style-type: none"> • Measurement of: <ul style="list-style-type: none"> ◦ power factors PF1, PF2, PF3 and cos φ 1, cos φ 2, cos φ 3 for each phase Only with 4-pole or 3-pole trip unit with ENVT option ◦ total power factor PF and cos φ • Maximum values: <ul style="list-style-type: none"> ◦ per phase of power factors PF1 MAX, PF2 MAX, PF3 MAX and cos φ 1 MAX, cos φ 2 MAX, cos φ 3 MAX ◦ of the power factor PF MAX and cos φ MAX • Minimum values: <ul style="list-style-type: none"> ◦ of the power factors PF1 MIN, PF2 MIN, PF3 MIN and cos φ 1 MIN, cos φ 2 MIN, cos φ 3 MIN Only with 4-pole or 3-pole trip unit with ENVT option ◦ of the total power factor PF MIN and cos φ MIN 	–	-1.00 to 1.00	+/-2%	-1.00 to -0.50 0.50 to 1.00
<ul style="list-style-type: none"> • Measurement of the total harmonic current distortion THD for each phase THD(I1), THD(I2), THD(I3) • Maximum values of the total harmonic current distortion THD for each phase THD(I1) MAX, THD(I2) MAX, THD(I3) MAX • Minimum values of the total harmonic current distortion THD for each phase THD(I1) MIN, THD(I2) MIN, THD(I3) MIN 	% I _{fund}	0– >1000%	+/-10%	10–500% I >20% I _n
<ul style="list-style-type: none"> • Measurement of the total harmonic phase-to-phase voltage THD(V12) L-L, THD(V23) L-L, THD(V31) L-L and phase-to-neutral voltage THD(V1N) L-N, THD(V2N) L-N, THD(V3N) L-N distortion ⁽¹⁾ • Maximum values of the total harmonic phase-to-phase voltage THD(V12) MAX L-L, THD(V23) MAX L-L, THD(V31) MAX L-L and phase-to-neutral voltage THD(V1N) MAX L-N, THD(V2N) MAX L-N, THD(V3N) MAX L-N distortion⁽¹⁾ • Minimum values of the total harmonic phase-to-phase voltage THD(V12) MIN L-L, THD(V23) MIN L-L, THD(V31) MIN L-L and phase-to-neutral voltage THD(V1N) MIN L-N, THD(V2N) MIN L-N, THD(V3N) MIN L-N distortion⁽¹⁾ 	% V _{fund} L-L % V _{fund} L-N	0– >1000%	+/-5%	2–500% V >100 V
<ul style="list-style-type: none"> • Frequency measurement • Maximum frequency • Minimum frequency 	Hz	15–440	+/-0.2%	45–65
(1) THD(V1N), THD(V2N), THD(V3N) with 4-pole or 3-pole trip unit with ENVT option				

Motor Thermal Image (MicroLogic 6 E-M)

The accuracy range is for the current range: 0.2–1.2 I_n.

Measurement	Unit	Measurement range	Accuracy	Accuracy range
<ul style="list-style-type: none"> • Motor thermal image measurements • Maximum value of the motor thermal image • Minimum value of the motor thermal image 	% I _r	0–100%	+/-1%	0–100%

Demand Value Measurements

Current Demand and Peak Values

Measurement	Unit	Measurement range	Accuracy	Accuracy range
<ul style="list-style-type: none"> Phase (I1, I2, I3) and neutral (IN) current demand values ⁽¹⁾ Phase (I1, I2, I3) and neutral (IN) peak current values ⁽¹⁾ 	A	0–20 I _n	+/-1.5%	0.2–1.2 I _n
(1) IN with 4-pole or 3-pole trip unit with ENCT option				

Power Demand and Peak Values

The accuracy range is for:

- current range: 0.1–1.2 I_n
- voltage range: 70–850 V
- cos ϕ range: -1–0.5 and 0.5–1

Measurement	Unit	Measurement range	Accuracy	Accuracy range
<ul style="list-style-type: none"> Demand value of the total active power (P_{tot}) Total active power peak value (P_{tot}) 	kW	0–3000 kW	+/-2%	3–3000 kW
<ul style="list-style-type: none"> Demand value of the total reactive power (Q_{tot}) Total reactive power peak value (Q_{tot}) 	kVAR	0–3000 kVAR	+/-2%	3–3000 kVAR
<ul style="list-style-type: none"> Demand value of the total apparent power (S_{tot}) Total apparent power peak value (S_{tot}) 	kVA	0–3000 kVA	+/-2%	3–3000 kVA

Energy Metering

Energy Meters

The accuracy range is for:

- current range: 0.1–1.2 I_n
- voltage range: 70–850 V
- $\cos \phi$ range: -1–0.5 and 0.5–1

Measurement	Unit	Measurement range	Accuracy	Accuracy range
Active energy measurements: E _p , E _{pIn} supplied, and E _{pOut} consumed	kWh then MWh	1 kWh to > 1000 TWh	+/-2%	1 kWh to 1000 TWh
Reactive energy measurements: E _q , E _{qIn} supplied, and E _{qOut} consumed	kVARh then MVARh	1 kVARh to > 1000 TVARh	+/-2%	1 kVARh to 1000 TVARh
Apparent energy measurement E _s	kVAh then MVAh	1 kVAh to > 1000 TVAh	+/-2%	1 kVAh to 1000 TVAh

Alarms

What's in This Part

Alarms Associated with Measurements	141
Alarms on a Trip, Failure, and Maintenance Event	145
Tables of Alarms	146
Operation of SDx and SDTAM Module Outputs Assigned to Alarms	150

Alarms Associated with Measurements

Presentation

MicroLogic 5, 6, and 7 trip units monitor measurements using:

- One or two pre-alarms (depending on the type of trip unit) assigned to:
 - Long-time protection (PAL Ir) for the MicroLogic 5 trip unit
 - Long-time protection (PAL Ir) and ground-fault protection (PAL Ig) for the MicroLogic 6 trip unit
 - Long-time protection (PAL Ir) and earth-leakage protection (PAL IΔn) for the MicroLogic 7 trip unit.

By default, these alarms are active.

- Ten alarms defined by the user as required. The user assigns each of these alarms to a measurement.

By default, these alarms are not active.

All the alarms associated with measurements are accessible:

- Using the communication network
- On the FDM121 display

The alarms associated with measurements can be assigned to an SDx module output using EcoStruxure Power Commission software, page 150.

Alarm Setup

Select user-defined alarms and set their functions using EcoStruxure Power Commission software.

Alarm setup consists of:

- Selecting the alarm priority level
- Setting the alarm activation thresholds and time delays

The alarm description tables, page 146 indicate for each of the alarms:

- The setting range (thresholds and time delays)
- The default setting values

Alarm Priority Level

Each alarm is assigned a priority level:

- High priority
- Medium priority
- Low priority
- No priority

Alarm indication on the FDM121 display depends on the alarm priority level.

The user sets the priority level of each alarm, according to the urgency of the action required.

By default, alarms are medium priority, except for alarms associated with operating indicators which are low priority.

Alarm Activation Conditions

An alarm associated with a measurement is activated when:

- Values rise above the measurement pickup threshold for overvalue conditions.
- Values drop below the measurement pickup threshold for undervalue conditions.
- Values equal to the measurement pickup threshold for equality conditions.

The alarm activation condition can be preset by using EcoStruxure Power Commission software.

Overvalue Condition

Activation of the alarm on overvalue condition is determined using two thresholds and two time delays.

The following figure illustrates activation of an alarm on an overvalue condition.

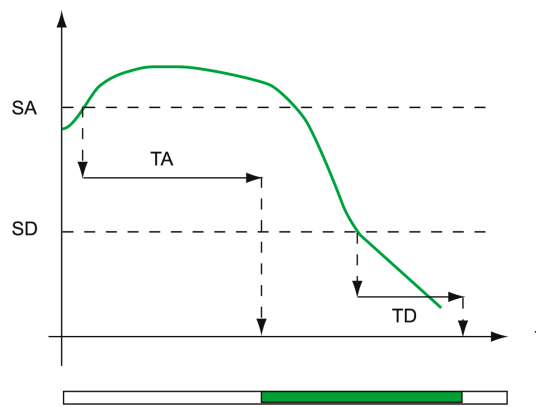

SA Pickup threshold

TA Pickup time delay

SD Drop-out threshold

TD Drop-out time delay

1 Alarm: pickup zone (in green)

Undervalue Condition

Activation of the alarm on an undervalue condition is determined using two thresholds and two time delays.

The following figure illustrates activation of an alarm on an undervalue condition.

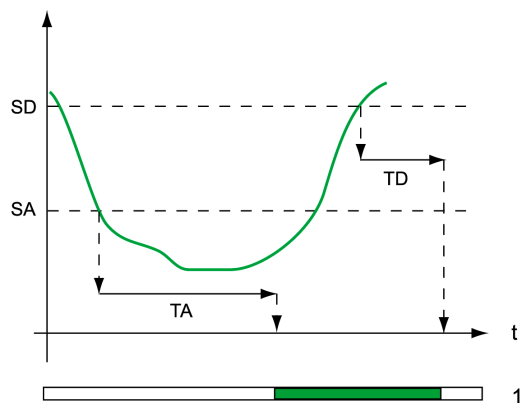

- SA** Pickup threshold
- TA** Pickup time delay
- SD** Drop-out threshold
- TD** Drop-out time delay
- 1** Alarm: pickup zone (in green)

Equality Condition

The alarm is activated when the associated monitored quantity equals the pickup threshold.

The alarm is deactivated when the associated monitored quantity is different from the pickup threshold.

Alarm activation is determined using the pickup/drop-out thresholds.

The following figure illustrates activation of an alarm on an equality condition (monitoring of quadrant4):

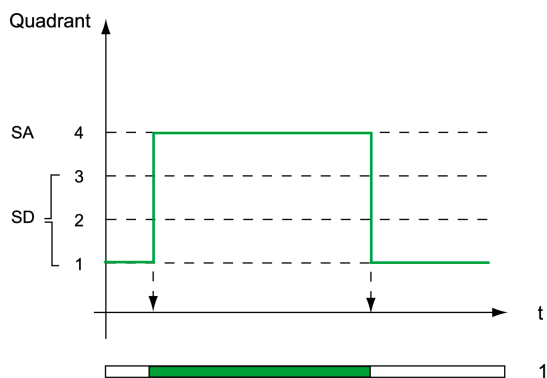

- SA** Pickup threshold
- SD** Drop-out thresholds
- 1** Quadrant 4 alarm: pickup zone (in green)

Management of Time Delays (Overvalue or Undervalue Conditions)

The alarm time delays are managed by two counters that are normally at 0.

For the pickup threshold, the time delay counter is:

- incremented when the activation condition is fulfilled.
- decremented if the activation condition is no longer fulfilled (before the end of the pickup time delay).

If the deactivation condition is reached, the pickup time delay counter is reset and the drop-out time delay counter is incremented.

For the drop-out threshold, the same principle is used.

Example: Management of the time delay on an overvoltage alarm (code 79)

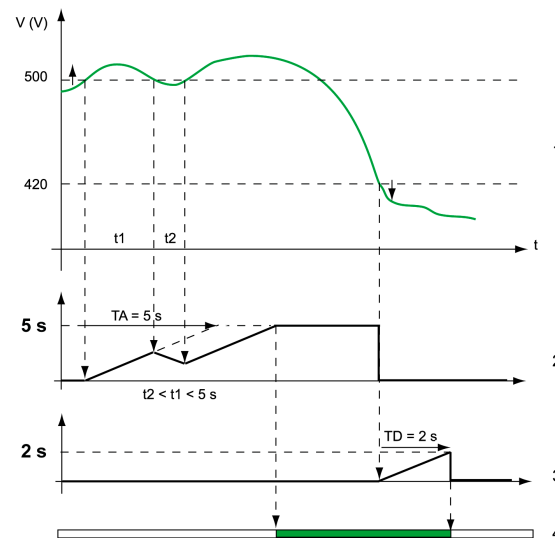

1 Evolution of the voltage

2 Pickup time delay counter at 5 s

3 Drop-out time delay counter at 2 s

4 Overvoltage alarm: pickup zone (in green)

The alarm pickup time delay counter trips when the voltage crosses 500 V threshold. It is incremented or decremented according to the value of the voltage in relation to the threshold.

The alarm drop-out time delay counter trips when the voltage drops back below the 420 V threshold.

Alarms on a Trip, Failure, and Maintenance Event

Presentation

Alarms on a trip, failure, and maintenance event are always active. They can be accessed:

- Using the communication network
- On the FDM121 display

Certain alarms can be assigned to an SDx module output by using EcoStruxure Power Commission software, page 150.

Alarm Setup

The functions of alarms on a trip and failure event are fixed and cannot be modified.

The functions of the two maintenance alarms (OF operation overrun counter threshold and Close command counter threshold) can be modified:

- With EcoStruxure Power Commission software (password-protected)
- By sending a setting command using the communication network (password-protected)

Alarm Priority Level

Assign each alarm a priority level:

- High priority
- Medium priority

Tables of Alarms

Pre-Alarms

By default, pre-alarms are active and are medium priority.

Label	Code	Setting range		Factory setting			
		Thresholds (pickup or drop-out)	Time delay	Thresholds		Time delay	
				Pickup	Drop-out	Pickup	Drop-out
Pre-alarm I _r (PAL I _r)	1013	40–100% I _r	1 s	90% I _r	85% I _r	1 s	1 s
Pre-alarm I _g (PAL I _g) (MicroLogic 6 trip unit)	1014	40–100% I _g	1 s	90% I _g	85% I _g	1 s	1 s
Pre-alarm IΔn (PAL IΔn) (MicroLogic 7 trip unit)	1015	50–80% IΔn	1 s	80% IΔn	75% IΔn	1 s	1 s

User-Defined Alarms

By default:

- User-defined alarms are not active.
- Alarms 1 to 144 are medium priority.
- Alarms 145 to 150 are low priority.

Label	Code	Setting range		Factory setting		
		Thresholds (pickup or drop-out)	Time delay	Thresholds	Time delay	
					Pickup	Drop-out
Over Current inst I1	1	0.2–10 I _n	1–3000 s	I _n	40 s	10 s
Over Current inst I2	2	0.2–10 I _n	1–3000 s	I _n	40 s	10 s
Over Current inst I3	3	0.2–10 I _n	1–3000 s	I _n	40 s	10 s
Over Current inst I _N	4	0.2–10 I _n	1–3000 s	I _n	40 s	10 s
Ground-fault alarm (MicroLogic 6 trip unit)	5	10–100% I _g	1–3000 s	40% I _g	40 s	10 s
Under Current inst I1	6	0.2–10 I _n	1–3000 s	0.2 I _n	40 s	10 s
Under Current inst I2	7	0.2–10 I _n	1–3000 s	0.2 I _n	40 s	10 s
Under Current inst I3	8	0.2–10 I _n	1–3000 s	0.2 I _n	40 s	10 s
Over I _{unbal} phase 1	9	5–60% I _{avg}	1–3000 s	25%	40 s	10 s
Over I _{unbal} phase 2	10	5–60% I _{avg}	1–3000 s	25%	40 s	10 s
Over I _{unbal} phase 3	11	5–60% I _{avg}	1–3000 s	25%	40 s	10 s
Over Voltage V1N	12	100–1100 V	1–3000 s	300 V	40 s	10 s
Over Voltage V2N	13	100–1100 V	1–3000 s	300 V	40 s	10 s
Over Voltage V3N	14	100–1100 V	1–3000 s	300 V	40 s	10 s
Under Voltage V1N	15	100–1100 V	1–3000 s	180 V	40 s	10 s
Under Voltage V2N	16	100–1100 V	1–3000 s	180 V	40 s	10 s
Under Voltage V3N	17	100–1100 V	1–3000 s	180 V	40 s	10 s
Over V _{unbal} V1N	18	2%–30% V _{avg}	1–3000 s	10%	40 s	10 s
Over V _{unbal} V2N	19	2%–30% V _{avg}	1–3000 s	10%	40 s	10 s

Label	Code	Setting range		Factory setting		
		Thresholds (pickup or drop-out)	Time delay	Thresholds	Time delay	
					Pickup	Drop-out
Over Vunbal V3N	20	2%–30% Vavg	1–3000 s	10%	40 s	10 s
Over total KVA	21	1–1000 kVA	1–3000 s	100 kVA	40 s	10 s
Over direct KW	22	1–1000 kW	1–3000 s	100 kW	40 s	10 s
Reverse power KW	23	1–1000 kW	1–3000 s	100 kW	40 s	10 s
Over direct kVAR	24	1–1000 kVAR	1–3000 s	100 kVAR	40 s	10 s
Reverse power kVAR	25	1–1000 kVAR	1–3000 s	100 kVAR	40 s	10 s
Under total KVA	26	1–1000 kVA	1–3000 s	100 kVA	40 s	10 s
Under direct KW	27	1–1000 kW	1–3000 s	100 kW	40 s	10 s
Under direct kVAR	29	1–1000 kVAR	1–3000 s	100 kVAR	40 s	10 s
Leading PF (IEEE) ⁽¹⁾	31	0–0.99	1–3000 s	0.80	40 s	10 s
Lead or Lag PF (IEC) ⁽¹⁾	33	0–0.99	1–3000 s	0.80	40 s	10 s
Lagging PF (IEEE) ⁽¹⁾	34	-0.99–0	1–3000 s	-0.80	40 s	10 s
Over THD Current I1	35	0–500%	1–3000 s	15%	40 s	10 s
Over THD Current I2	36	0–500%	1–3000 s	15%	40 s	10 s
Over THD Current I3	37	0–500%	1–3000 s	15%	40 s	10 s
Over THD V1N	38	0–500%	1–3000 s	5%	40 s	10 s
Over THD V2N	39	0–500%	1–3000 s	5%	40 s	10 s
Over THD V3N	40	0–500%	1–3000 s	5%	40 s	10 s
Over THD V12	41	0–500%	1–3000 s	5%	40 s	10 s
Over THD V23	42	0–500%	1–3000 s	5%	40 s	10 s
Over THD V31	43	0–500%	1–3000 s	5%	40 s	10 s
Earth-leakage current (MicroLogic 7 trip unit)	54	50–80% IΔn	1–3000 s	80% IΔn	40 s	10 s
Over Current Iavg	55	0.2–10 In	1–3000 s	In	60 s	15 s
Over I MAX (1, 2, 3)	56	0.2–10 In	1–3000 s	In	60 s	15 s
Under Current IN	57	0.2–10 In	1–3000 s	0.2 In	40 s	10 s
Under Current Iavg	60	0.2–10 In	1–3000 s	0.2 In	60 s	15 s
Over I1 Demand	61	0.2–10.5 In	1–3000 s	0.2 In	60 s	15 s
Over I2 Demand	62	0.2–10.5 In	1–3000 s	0.2 In	60 s	15 s
Over I3 Demand	63	0.2–10.5 In	1–3000 s	0.2 In	60 s	15 s
Over IN Demand	64	0.2–10.5 In	1–3000 s	0.2 In	60 s	15 s
Under I MIN (1, 2, 3)	65	0.2–10 In	1–3000 s	0.2 In	60 s	15 s
Under I1 Demand	66	0.2–10.5 In	1–3000 s	0.2 In	60 s	15 s
Under I2 Demand	67	0.2–10.5 In	1–3000 s	0.2 In	60 s	15 s
Under I3 Demand	68	0.2–10.5 In	1–3000 s	0.2 In	60 s	15 s
Under IN Demand	69	0.2–10.5 In	1–3000 s	0.2 In	60 s	15 s
Over Iunbal MAX	70	5–60% Iavg	1–3000 s	25%	40 s	10 s
Over Voltage V12	71	100–1100 V	1–3000 s	500 V	40 s	10 s
Over Voltage V23	72	100–1100 V	1–3000 s	500 V	40 s	10 s
Over Voltage V31	73	100–1100 V	1–3000 s	500 V	40 s	10 s
Over Volt Vavg L-N	75	100–1100 V	1–3000 s	300 V	5 s	2 s
Under Voltage V12	76	100–1100 V	1–3000 s	320 V	40 s	10 s
Under Voltage V23	77	100–1100 V	1–3000 s	320 V	40 s	10 s

Label	Code	Setting range		Factory setting		
		Thresholds (pickup or drop-out)	Time delay	Thresholds	Time delay	
					Pickup	Drop-out
Under Voltage V31	78	100–1100 V	1–3000 s	320 V	40 s	10 s
Over V MAX L-L	79	100–1100 V	1–3000 s	300 V	5 s	2 s
Under Voltage Vavg L-N	80	100–1100 V	1–3000 s	180 V	5 s	2 s
Under V MIN L-L	81	100–1100 V	1–3000 s	180 V	5 s	2
Over Vunbal MAX L-L	82	2%–30% Vavg	1–3000 s	10%	40 s	10 s
Over Vunbal V12	86	2%–30% Vavg	1–3000 s	10%	40 s	10 s
Over Vunbal V23	87	2%–30% Vavg	1–3000 s	10%	40 s	10 s
Over Vunbal V31	88	2%–30% Vavg	1–3000 s	10%	40 s	10 s
Over Vunbal MAX L-L	89	2%–30% Vavg	1–3000 s	10%	40 s	10 s
Phase sequence	90	0.1	–	0	–	–
Under Frequency	92	45–65 Hz	1–3000 s	45 Hz	5 s	2 s
Over Frequency	93	45–65 Hz	1–3000 s	65 Hz	5 s	2 s
Over KW Power dmd	99	1–1000 kW	1–3000 s	100 kW	40 s	10 s
Leading cos ϕ (IEEE) ⁽¹⁾	121	0–0.99	1–3000 s	0.80	40 s	10 s
Lead/Lag cos ϕ (IEC) ⁽¹⁾	123	0–0.99	1–3000 s	0.80	40 s	10 s
Lagging cos ϕ (IEEE) ⁽¹⁾	124	-0.99–0	1–3000 s	-0.80	40 s	10 s
Over T° image motor (MicroLogic 6 E-M trip unit)	125	0.2–10.5 In	1–3000 s	In	60 s	15 s
Under T° image motor (MicroLogic 6 E-M trip unit)	126	0.2–10.5 In	1–3000 s	In	60 s	15 s
Over I1 Peak Demand	141	0.2–10.5 In	1–3000 s	In	60 s	15 s
Over I2 Peak Demand	142	0.2–10.5 In	1–3000 s	In	60 s	15 s
Over I3 Peak Demand	143	0.2–10.5 In	1–3000 s	In	60 s	15 s
Over IN Peak Demand	144	0.2–10.5 In	1–3000 s	In	60 s	15 s
Lead	145	0.0	1–3000 s	0	40 s	10 s
Lag	146	1.1	1–3000 s	1	40 s	10 s
Quadrant 1	147	1.1	1–3000 s	1	40 s	10 s
Quadrant 2	148	2.2	1–3000 s	2	40 s	10 s
Quadrant 3	149	3.3	1–3000 s	3	40 s	10 s
Quadrant 4	150	4.4	1–3000 s	4	40 s	10 s

(1) The type of alarms associated with monitoring the cos ϕ and PF indicators must always be consistent with the sign convention (IEEE or IEC) for the PF indicator.

Alarms on a Trip Event

Label	Code	SDx output	Priority
Long-time prot Ir	16384	Yes	High
Short-time prot lsd	16385	Yes	High
Instant prot li	16386	Yes	High
Ground-fault Ig	16387	Yes	High
Earth-leakage lΔn	16388	Yes	High
Integ instant prot	16390	No	High

Label	Code	SDx output	Priority
Trip unit fail (Stop)	16391	Yes	High
Instant vigi (external module) prot	16392	No	High
Reflex tripping	16393	No	High
Phase unbalance	16640	Yes	High
Jam motor prot	16641	Yes	High
Under load mtr prot	16642	Yes	High
Long start mtr prot	16643	Yes	High
Trip indicator SD	1905	No	Medium

Alarms on a Failure Event

Label	Code	SDx output	Priority
BSCM failure (Stop)	1912	Yes	High
BSCM failure (Err)	1914	Yes	Medium

Alarms on a Maintenance Event

Label	Code	SDx output	Priority
OF operation overrun	1916	Yes	Medium
Close command overrun	1919	Yes	Medium
Wear on contacts	256	Yes	Medium

Operation of SDx and SDTAM Module Outputs Assigned to Alarms

Presentation

The two outputs on the SDx module can be assigned to two alarms by using EcoStruxure Power Commission software. They are activated (or deactivated) by the occurrence (or completion) of:

- An alarm associated with a measurement, page 141.
- An alarm on a trip, failure, and maintenance event, page 145.

The two outputs on the SDTAM module for motor-feeder applications cannot be configured:

- Output 1 is assigned to motor thermal fault indication
- Output 2 is used to open the contactor

For more information on the SDx and SDTAM modules, refer to DOCA0187** *ComPacT NSX - Circuit Breakers and Switch-Disconnectors 100–630 A - User Guide*, page 7.

Assignment of the SDx Module Outputs

All alarms on a trip, failure, and maintenance event, and all alarms associated with a measurement can be assigned to an SDx module output.

The factory setting for the SDx module output assignment depends on the type of MicroLogic trip unit installed on the module.

Both outputs are assigned by default as follows:

- MicroLogic 5 trip unit:
 - Output 1 is the thermal fault indication (SDT).
 - Output 2 is the long-time pre-alarm (PAL Ir).
- MicroLogic 6 trip unit:
 - Output 1 is the thermal fault indication (SDT) for electrical distribution applications.
Output 1 is **None** for motor-feeder applications.
 - Output 2 is the ground-fault indication (SDG).
- MicroLogic 7 trip unit with integrated earth-leakage protection:
 - Output 1 is the thermal fault indication (SDT).
 - Output 2 is the earth-leakage indication (SDV).

SDx Module Output Operating Modes

Set the operating mode for the SDx module outputs as:

- Non-latching
- Latching
- Time-delayed non-latching
- Closed forced
- Open forced

Operation in Non-Latching Mode

The output (**S**) position follows the associated alarm (**A**) transitions.

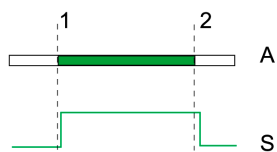

A Alarm: Green when activated, white when deactivated

S Output: High position = activated, Low position = deactivated

1 Alarm activation transition

2 Alarm deactivation transition

Operation in Latching Mode

The position of the output (**S**) follows the active transition of the associated alarm (**A**) and remains latched irrespective of the alarm state.

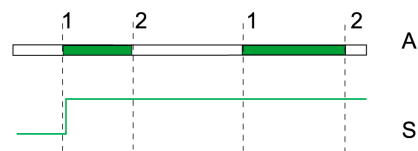

A Alarm: Green when activated, white when deactivated

S Output: High position = activated, Low position = deactivated

1 Alarm activation transition

2 Alarm deactivation transition

Operation in Time-Delayed Non-Latching Mode

The output (**S**) follows the activation transition for the associated alarm (**A**). The output returns to the deactivated position after a time delay irrespective of the alarm state.

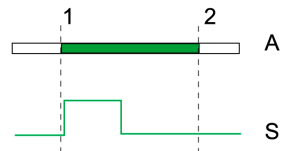

A Alarm: Green when activated, white when deactivated

S Output: High position = activated, Low position = deactivated

1 Alarm activation transition

2 Alarm deactivation transition

The setting range for the time delay is 1–360 s. The default time delay setting is 5 s. Set the time delay by using EcoStruxure Power Commission software.

Operation in Open or Closed Forced Mode

In Open forced mode, the output remains in the deactivated position irrespective of the alarm state.

In Closed forced mode, the output remains in the activated position irrespective of the alarm state.

NOTE: Both these modes can be used for debugging or checking an electrical installation.

Acknowledgment of Latching Mode

Acknowledge the latching mode using the MicroLogic trip unit keypad by pressing the **OK** key twice.

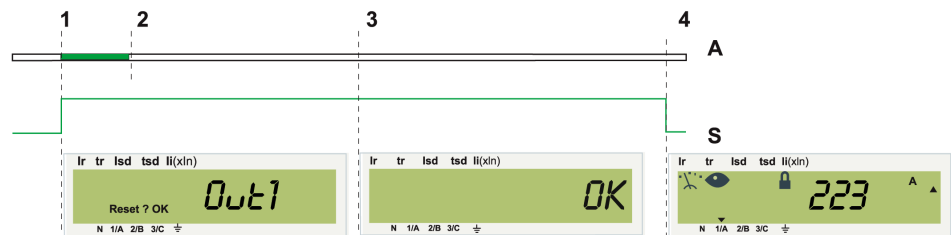

A Alarm: Green when activated, white when deactivated

S Output: High position = activated, Low position = deactivated

Step	Event/Action	Display information
1	Alarm activation	Out1 is displayed.
2	Alarm deactivation	Out1 message is still displayed.
3	Confirm active position of the output (press the OK key twice to confirm)	OK is displayed.
4	–	The screensaver is displayed.

Special Features of Latching Mode

If the acknowledge request is made when the alarm is still active:

- Acknowledgment of the output active position has no effect.
- Keypad navigation is possible.
- The screensaver returns to the **Out1** message.

If the two alarms associated with the two outputs in latching mode are active:

- The first alarm message **Out1** (or **Out2**) is displayed on the screen until the alarm is actually acknowledged (the output active position is acknowledged after the alarm is deactivated).
- After acknowledgment of the first alarm, the screen displays the second alarm message **Out2** (or **Out1**) until the second alarm is acknowledged.
- After both acknowledgments, the display returns to the screensaver.

Assignment of the SDTAM Module Outputs

Output 1 (SD2/OUT1), normally open, is assigned to motor thermal fault indication.

Output 2 (SD4/OUT2), normally closed, is used to open the contactor.

They are activated 400 ms before the circuit breaker trips in the case of:

- Long-time protection
- Phase unbalance protection
- Jam motor protection (MicroLogic 6 E-M trip unit)
- Underload protection (MicroLogic 6 E-M trip unit)

Operating Assistance



What's in This Part

LED Indication	155
Indication on the MicroLogic Display	157
Examples of Using Alarms	163
Alarm Monitoring of the $\cos \phi$ and Power Factor	164
Circuit Breaker Communication	167
History and Time-Stamped Information	169
Maintenance Indicators.....	170

LED Indication

Local Indicator

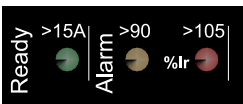
The LEDs and their meaning depend on the type of MicroLogic trip unit.

Type of MicroLogic trip unit	Description
Distribution 	<ul style="list-style-type: none"> Ready LED (green) blinks slowly when the standard protection functions of the electronic trip unit are operational. Overload pre-alarm LED (orange) lights when the load exceeds 90% of the I_r setting. Overload alarm LED (red) lights when the load exceeds 105% of the I_r setting.
Motor 	<ul style="list-style-type: none"> Ready LED (green) blinks slowly when the standard protection functions of the electronic trip unit are operational. Overload temperature alarm LED (red) lights when the motor thermal image exceeds 95% of the I_r setting.

Operation of the Ready LED

The **Ready** LED (green) blinks slowly when the standard protection functions of the electronic trip unit are operational. It indicates that the trip unit is operating correctly.

For MicroLogic 5 and 6 trip units: the **Ready** LED blinks at a value equal to the sum of the circuit breaker current for each phase and the neutral above a limit value. This limit value is indicated above the **Ready** LED, on the front face of the MicroLogic trip unit.

The following table uses two examples to illustrate the comparison of the phase and neutral currents with the activation limit value of the **Ready** LED:

MicroLogic 5.2 trip unit, 40 A rating, 3-pole	MicroLogic 5.3 trip unit, 400 A rating, 4-pole
The limit value is 15 A.	The limit value is 50 A.
This limit value can be: <ul style="list-style-type: none"> The sum of the 5 A phase current intensities (three balanced phases). 7.5 A in each of two phases (the current intensity in the third phase is zero). 15 A in one phase if the circuit breaker (3-pole): <ul style="list-style-type: none"> is installed on a distribution with distributed neutral. only has one loaded phase on a single-phase load. The current in the other two phases is zero.	This limit value can be: <ul style="list-style-type: none"> The sum of the three 15 A phase current intensities and a 5 A neutral current intensity. 25 A in each of two phases (the current intensity in the third phase and in the neutral is zero). 25 A in one phase and in the neutral (the current intensity in the other two phases is zero).

The MicroLogic 7 trip unit with integrated earth-leakage protection has an internal voltage power supply (in addition to the supply provided by the current transformers) to power the earth-leakage protection even when the current demand is low. The **Ready** LED blinks irrespective of the load, indicating that the standard protection functions are operational.

Operation of Pre-Alarm and Alarm LEDs (Electrical Distribution Protection)

The pre-alarm (orange LED) and alarm (red LED) indications trip as soon as the value of one of the phase currents exceeds 90% and 105% respectively of the I_r pickup setting:

- Pre-alarm
Exceeding the pre-alarm threshold at 90% of I_r has no effect on the long-time protection.
- Alarm
Crossing the alarm threshold at 105% of I_r activates the long-time protection, page 61 with a trip time delay that depends on:
 - The value of the current in the load
 - The setting of the time delay t_r

NOTE: If the pre-alarm and alarm LEDs keep lighting up, carry out load shedding to avoid tripping due to a circuit breaker overload.

The following figure illustrates the information supplied by the LEDs:

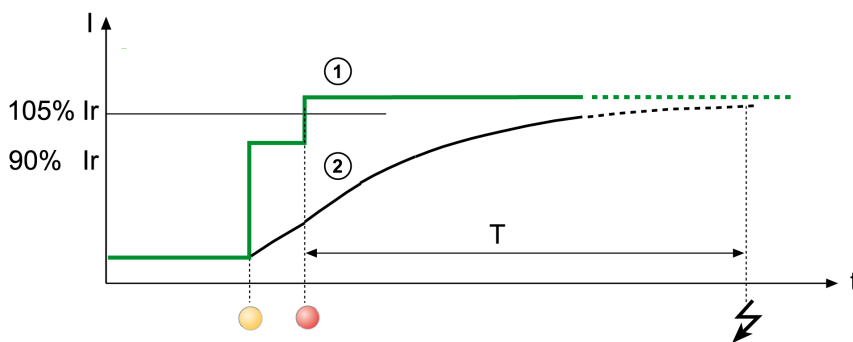

- 1 Current in the load (most heavily loaded phase)
- 2 Thermal image calculated by the trip unit

Operation of Alarm LEDs (Motor Protection)

The alarm indication (red LED) trips as soon as the value of the motor thermal image exceeds 95% of the I_r pickup setting.

Crossing the threshold of 95% of I_r is a temperature alarm: long-time protection is not activated.

The following figure illustrates the information supplied by the LED:

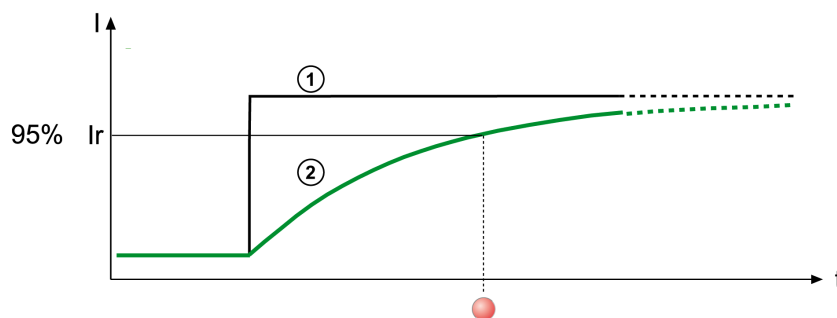

- 1 Current in the load
- 2 Thermal image calculated by the trip unit

Indication on the MicroLogic Display

Presentation

Indication screens indicate the status of the installation.

Maintenance interventions should be executed according to the priority level:

- Configured (alarms: high, medium, low, or no priority)
- Pre-defined (trip and failure events: high or medium priority)

Stacking Screens

When a number of events arrive simultaneously, they stack according to their criticality level: 0 (no criticality) to 4 (high criticality).

Criticality	Screen ⁽¹⁾
0	Main screen
1	Outx alarm screen
2	Err internal failure screen
3	Stop internal fault screen
4	Trip screen
(1) The screens and their acknowledgment procedure are described below.	

Example:

An alarm on a voltage measurement **Outx**, then an internal failure **Err** occurred:

- The screen displayed is the internal failure **Err** screen (Criticality = 2).
- After acknowledging the internal failure **Err** screen, the alarm **Outx** screen is displayed (Criticality = 1).
- After acknowledging the internal failure **Outx** screen, the main screen is displayed (Criticality = 0).

The same acknowledgment sequence should be performed if the internal failure **Err** occurred before the voltage measurement **Outx**.

Safety Instructions

⚡⚠ DANGER

HAZARD OF ELECTRIC SHOCK, EXPLOSION, OR ARC FLASH

- If the trip unit displays a **StOp** screen, replace the MicroLogic trip unit immediately.
- If trip unit displays a fault screen, do not close the circuit breaker again without first inspecting and, if necessary, repairing the downstream electrical equipment.
- Apply appropriate personal protective equipment (PPE) and follow safe electrical work practices. See NFPA 70E or CSA Z462 or local equivalent.
- This equipment must only be installed and serviced by qualified electrical personnel.
- Turn off all power supplying this equipment before working on or inside equipment.
- Always use a properly rated voltage sensing device to confirm that power is off.
- Replace all devices, doors, and covers before turning on power to this equipment.

Failure to follow these instructions will result in death or serious injury.

⚠ CAUTION

HAZARD OF INCORRECT INFORMATION

If the trip unit displays an *E r r* screen, replace the MicroLogic trip unit at the next regular maintenance.

Failure to follow these instructions can result in injury or equipment damage.

Indication of Correct Installation Operation

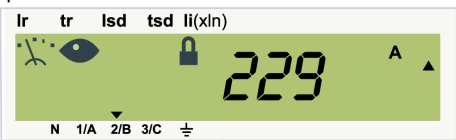
Screen	Cause
<p>I phase 2</p> 	<p>The main screen displays the current value of the most heavily loaded phase.</p>

Alarm Indication

Circuit breaker with SDx module option

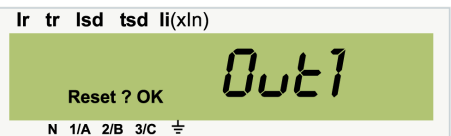

Screen	Cause
<p>Outx</p> 	<p>An alarm configured on the SDx module in permanent latching mode has not been acknowledged, page 152 or the acknowledgment request is made when the alarm is still active.</p>

Check the cause of the alarm and acknowledge the alarm by pressing the **OK** key twice (validation and confirmation).

The main screen (current value of the most heavily loaded phase) is displayed.

Indication of Faults With MicroLogic 5, 6, and 7 Trip Units

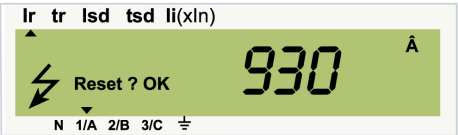
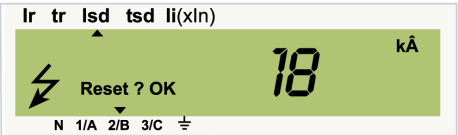
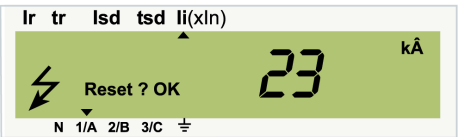
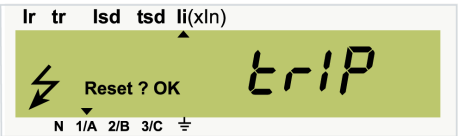
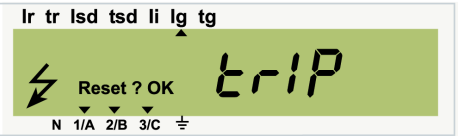
For more information about definitions of the protections associated with indications, refer to the electrical distribution protection, page 57.

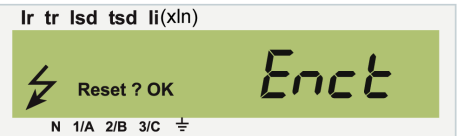
Screen	Cause
<p>Breaking current I_r</p> 	Tripped by long-time protection: Up arrow pointing to I_r , breaking value displayed
<p>Peak breaking current I_{sd}</p> 	Tripped by short-time protection: Up arrow pointing to I_{sd} , breaking value displayed
<p>Peak breaking current I_i</p> 	Tripped by instantaneous protection or reflex protection: Up arrow pointing to I_i , breaking value displayed
	Tripped by integrated instantaneous protection: Up arrow pointing to I_i , triP displayed
	MicroLogic 6 trip unit Tripped by ground-fault protection: Up arrow pointing to I_g , triP displayed
	MicroLogic 7 trip unit with integrated earth-leakage protection Tripped by earth-leakage protection: Up arrow pointing to $I_{\Delta n}$
	Tripped due to lack of ENCT option, as the ENCT option was declared during the protection function settings of the MicroLogic trip unit. Install the ENCT option or connect a jumper between terminals T1 and T2 on the MicroLogic trip unit.

Indication of Faults With MicroLogic 6 E-M Trip Unit

For more information about definitions of the protections associated with indications, refer to the protection for motor-feeders, page 83.

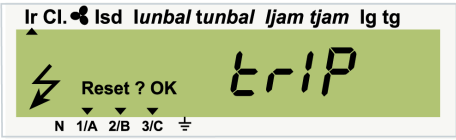
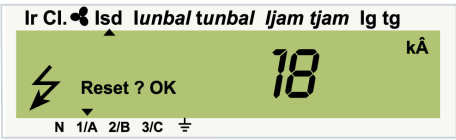
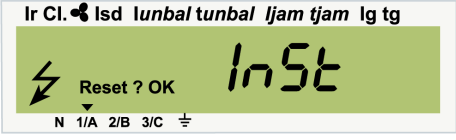
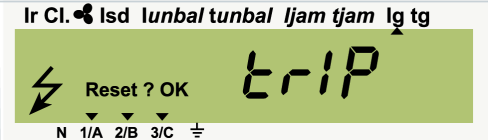
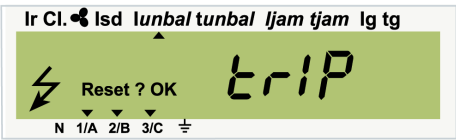
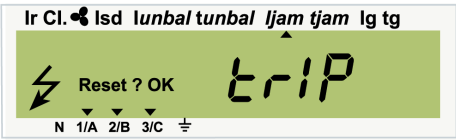
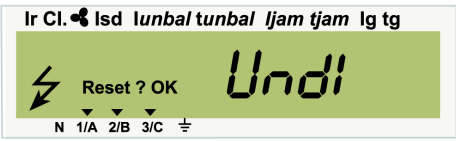
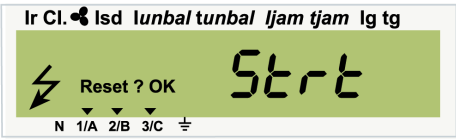
Screen	Cause
 <p>The display shows the menu 'Ir Cl. Isd lunbal tunbal ljam tjam lg tg' at the top. Below it is a lightning bolt icon, 'Reset ? OK', and the word 'trip' in large digits. At the bottom are labels 'N 1/A 2/B 3/C' and a ground symbol. An up arrow points to 'Ir'.</p>	Tripped by long-time protection: Up arrow pointing to Ir, trip displayed ⁽¹⁾
<p>Peak breaking current Isd</p>  <p>The display shows the menu 'Ir Cl. Isd lunbal tunbal ljam tjam lg tg' at the top. Below it is a lightning bolt icon, 'Reset ? OK', and the value '18' followed by 'kA'. At the bottom are labels 'N 1/A 2/B 3/C' and a ground symbol. An up arrow points to 'Isd'.</p>	Tripped by short-time protection: Up arrow pointing to Isd, breaking value displayed
 <p>The display shows the menu 'Ir Cl. Isd lunbal tunbal ljam tjam lg tg' at the top. Below it is a lightning bolt icon, 'Reset ? OK', and the word 'Inst' in large digits. At the bottom are labels 'N 1/A 2/B 3/C' and a ground symbol. An up arrow points to 'lunbal'.</p>	Tripped by instantaneous protection or reflex protection: Inst displayed
 <p>The display shows the menu 'Ir Cl. Isd lunbal tunbal ljam tjam lg tg' at the top. Below it is a lightning bolt icon, 'Reset ? OK', and the word 'trip' in large digits. At the bottom are labels 'N 1/A 2/B 3/C' and a ground symbol. An up arrow points to 'lg'.</p>	Tripped by ground-fault protection: Up arrow pointing to lg, trip displayed
 <p>The display shows the menu 'Ir Cl. Isd lunbal tunbal ljam tjam lg tg' at the top. Below it is a lightning bolt icon, 'Reset ? OK', and the word 'trip' in large digits. At the bottom are labels 'N 1/A 2/B 3/C' and a ground symbol. An up arrow points to 'lunbal'.</p>	Tripped by unbalance protection: Up arrow pointing to lunbal, trip displayed ⁽¹⁾
 <p>The display shows the menu 'Ir Cl. Isd lunbal tunbal ljam tjam lg tg' at the top. Below it is a lightning bolt icon, 'Reset ? OK', and the word 'trip' in large digits. At the bottom are labels 'N 1/A 2/B 3/C' and a ground symbol. An up arrow points to 'ljam'.</p>	Tripped by jam motor protection: Up arrow pointing to ljam, trip displayed ⁽¹⁾
 <p>The display shows the menu 'Ir Cl. Isd lunbal tunbal ljam tjam lg tg' at the top. Below it is a lightning bolt icon, 'Reset ? OK', and the word 'Undl' in large digits. At the bottom are labels 'N 1/A 2/B 3/C' and a ground symbol. An up arrow points to 'ljam'.</p>	Tripped by underload protection: Undl displayed ⁽¹⁾
 <p>The display shows the menu 'Ir Cl. Isd lunbal tunbal ljam tjam lg tg' at the top. Below it is a lightning bolt icon, 'Reset ? OK', and the word 'Strt' in large digits. At the bottom are labels 'N 1/A 2/B 3/C' and a ground symbol. An up arrow points to 'lg'.</p>	Tripped by long-start protection: Strt displayed
<p>(1) These trip causes can be managed automatically by SDTAM output 2 (OUT2) action on the contactor, page 150.</p>	

Acknowledging the Trip Screens

Acknowledge the trip screens by pressing the **OK** key twice (validation and confirmation).

⚠ WARNING
HAZARD OF CLOSING ON ELECTRICAL FAULT
Do not close the circuit breaker again without first inspecting and, if necessary, repairing the downstream electrical equipment.
Failure to follow these instructions can result in death, serious injury, or equipment damage.

The fact that a protection has tripped does not remedy the cause of the fault on the downstream electrical equipment.

Step	Action
1	Isolate the feed before inspecting the downstream electrical equipment.
2	Look for the cause of the fault.
3	Inspect and, if necessary, repair the downstream equipment.
4	Inspect the equipment in the event of a short-circuit trip.
5	Reset and close the circuit breaker again.

For more information about troubleshooting and restarting following a fault, refer to DOCA0187•• *ComPacT NSX - Circuit Breakers and Switch-Disconnectors 100–630 A - User Guide*, page 7.

Indication of a Minor Internal Malfunction of the MicroLogic Trip Unit

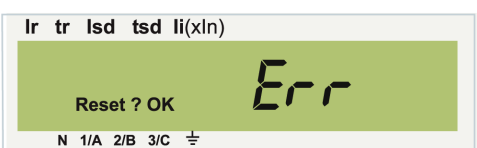
Screen	Cause
	A minor internal malfunction on the MicroLogic trip unit, whether temporary or permanent, has occurred without the circuit breaker tripping (the failure does not affect the trip unit protection functions).

⚠ CAUTION
HAZARD OF INCORRECT INFORMATION
Replace the MicroLogic trip unit at the next maintenance interval.
Failure to follow these instructions can result in injury or equipment damage.

Acknowledging the Err Screen

Acknowledge the **Err** screen by pressing the key twice **OK** (validation and confirmation):

- The Mode key can access the measurements and settings.
- The **Err** screen becomes the main screen if the failure is permanent.

Indication of a Major Internal Malfunction of the MicroLogic Trip Unit

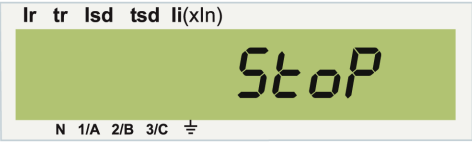
Screen	Cause
	A major internal malfunction has occurred in the MicroLogic trip unit. This fault trips the circuit breaker.

▲ CAUTION
<p>HAZARD OF INCORRECT INFORMATION</p> <p>Replace the MicroLogic trip unit immediately.</p> <p>Failure to follow these instructions can result in injury or equipment damage.</p>

Acknowledging the St0P Screen

The **St0P** screen cannot be acknowledged with the **OK** key:

- It is no longer possible to close the circuit breaker
- The Mode key cannot access the measurements and settings
- The **St0P** screen becomes the main screen

Screen Firmware Download Indication

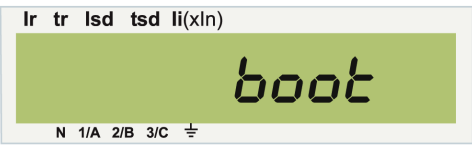
Screen	Cause
	<p>The MicroLogic trip unit is waiting for, or is downloading, the firmware through EcoStruxure Power Commission software (duration: 3 minutes approximately).</p> <ul style="list-style-type: none"> • The trip unit protections are still operational. • Access to measurements and settings (using the MicroLogic trip unit dials or keypad or using the communication network) is interrupted. <p>If the boot message persists after several download attempts, replace the MicroLogic trip unit.</p>

Examples of Using Alarms

Presentation

Use EcoStruxure Power Commission software to select:

- Quantity to be monitored
- Alarm function settings

Overvalue Condition

Alarms on overvalue condition are dedicated to monitoring:

- Overvoltages
- Phase unbalance (MicroLogic 6 E-M trip unit)
- Overcurrents
- Overfrequencies
- Current unbalances
- Power overruns
- Total harmonic distortion (THD) overruns

The value of the drop-out threshold must always be lower than the pickup threshold.

Undervalue Condition

The value of the drop-out threshold must always be higher than the pickup threshold.

Alarms on undervalue condition are dedicated to supervision of:

- Undervoltages
- Underloads (MicroLogic 6 E-M trip unit)
- Underfrequencies

Alarms on Equality Condition

The measurements associated with alarms on an equality condition correspond to a load state:

- Operating quadrant
- Leading or lagging reactive power

Alarm Monitoring of the $\cos \phi$ and Power Factor

Managing the $\cos \phi$ and Power Factor PF

Monitoring of the $\cos \phi$ and power factor PF indicators depends on the sign convention selected for the power factor PF: IEEE or IEC convention, page 128.

NOTE: The alarm type associated with the indicators - for example, leading PF (IEEE) (code 31) or lead/lag PF (IEC) (code 33) - must be consistent with the sign convention selected (IEEE or IEC) for the PF indicator.

Select the sign convention for the PF indicator:

- With EcoStruxure Power Commission software (password-protected)
- By sending a setting command using the communication network (password-protected)

The IEEE convention is the factory setting.

Indicator Maximum and Minimum Values

- The maximum value of the PF MAX or ($\cos \phi$ MAX) indicator is obtained for the smallest positive value of the PF (or $\cos \phi$) indicator.
- The minimum value of the PF MIN or ($\cos \phi$ MIN) indicator is obtained for the largest negative value of the PF (or $\cos \phi$) indicator.

Electrical Distribution Monitored According to IEEE Convention

The following example describes monitoring of the energy quality by the $\cos \phi$ indicator.

The following table gives the history of the $\cos \phi$ values of the load of a workshop downstream of a ComPacT NSX circuit breaker according to IEEE convention:

Time	Evolution of the load	IEEE convention		
		$\cos \phi$	$\cos \phi$ MIN	$\cos \phi$ MAX
t1 = 8 h 00 min	Power startup	- 0.4	- 0.4	- 0.4
t2 = 8 h 01 min	Compensation system startup	- 0.9	- 0.4	- 0.9
t3 = 9 h 20 min	Power stops	+ 0.3	- 0.4	+ 0.3
t4 = 9 h 21 min	Compensation system stops	- 0.95	- 0.4	+ 0.3

Interpreting the $\cos \phi$ MIN/MAX and the $\cos \phi$ Values According to IEEE Convention

The $\cos \phi$ MIN and $\cos \phi$ MAX values correspond to the $\cos \phi$ variation range for the load. This provides the user with information on how the equipment is performing from a cost point of view and allows the installation of compensation devices, if necessary. The $\cos \phi$ MIN and $\cos \phi$ MAX values can be accessed on the FDM121 display.

The load $\cos \phi$ values indicate in real time any correction actions:

- The absolute value of too low a negative $\cos \phi$ ($= -0.4$) indicates that capacitors need to be installed to increase the value of the equipment $\cos \phi$.
- The value of too low a positive $\cos \phi$ ($= +0.3$) indicates that capacitors need to be removed to increase the value of the equipment $\cos \phi$.

The two alarms on the $\cos \phi$ according to IEEE convention integrated in the MicroLogic trip unit are used to monitor the two critical situations automatically.

Electrical Distribution Monitored According to IEC Convention

The following table gives the history of the $\cos \phi$ values of the load of a workshop downstream of a ComPacT NSX circuit breaker according to IEC convention:

Time	Evolution of the load	IEC convention		
		$\cos \phi$	$\cos \phi$ MIN	$\cos \phi$ MAX
t1 = 8 h 00 min	Power startup	+ 0.4	+ 0.4	+ 0.4
t2 = 8 h 01 min	Compensation system startup	+ 0.9	+ 0.9	+ 0.4
t3 = 9 h 20 min	Power stops	+ 0.3	+ 0.9	+ 0.3
t4 = 9 h 21 min	Compensation system stops	+ 0.95	+ 0.95	+ 0.3

Interpreting the $\cos \phi$ MAX and the $\cos \phi$ Values According to IEC Convention

The $\cos \phi$ MAX value corresponds to the minimum value of the load $\cos \phi$, whether leading or lagging. This provides user information on how the equipment is performing from a cost point of view.

Do not use just the value of $\cos \phi$ to decide whether to install inductances or capacitors to increase its value.

If a critical situation occurs, the alarm on the $\cos \phi$ sends an alert according to IEC convention integrated in the MicroLogic trip unit. Use this alarm, associated with an alarm defining the type of load or the operating quadrant, to monitor the two critical situations automatically.

Setting the $\cos \phi$ Alarms According to IEEE Convention

Monitor the $\cos \phi$ indicator to manage the power:

- When the power starts, too high a value of $\cos \phi$ (lagging), for example higher than -0.6 , results in penalties. The capacitive compensation value determines the value of the Qfund reactive power.
- When the power stops, too low a value of $\cos \phi$ (leading), for example less than $+0.6$, results in penalties. Disconnect the capacitive compensation element.

Two alarms monitor the indicators:

- Alarm 124 (monitoring of the lagging $\cos \phi$) on an overvalue condition for operation in quadrant 1 (inductive reactive energy consumed)
- Alarm 121 (monitoring of the leading $\cos \phi$) on an undervalue condition for operation in quadrant 4 (capacitive reactive energy consumed)

Set the parameters for monitoring the $\cos \phi$ (alarms 121 and 124) according to IEEE convention with EcoStruxure Power Commission software.

Setting the SDx Outputs

The two alarms defined can each be associated with an SDx module output, page 150:

- With output **Out1**, alarm code 124 (monitoring of the lagging $\cos \phi$)
- With output **Out2**, alarm code 121 (monitoring of the leading $\cos \phi$)

On starting the power at t2, the inductive load (lagging) is too high and output Out1 is activated (the output must be configured in permanent latching mode). The MicroLogic trip unit display shows:

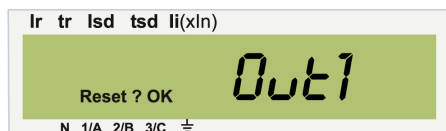

Acknowledging the Out1 Screen

The Out1 screen can only be acknowledged if the alarm is no longer active.

After startup of the capacitive compensation, the alarm is no longer active. Press the **OK** key twice (validation and confirmation) to acknowledge Out1 output.

Circuit Breaker Communication

Presentation

ComPacT NSX circuit breakers with MicroLogic 5, 6, and 7 trip units can be integrated into a communication network using Modbus protocol. Use data transmitted by the communication network to provide supervision and monitoring for an installation.

Modbus communication offers the options of:

- Reading remotely:
 - The circuit breaker status
 - Measurements
 - Operating assistance information
- Controlling the circuit breaker remotely.

For more information about the Modbus communication network, refer to DOCA0213•• *ComPacT NSX - Modbus Communication Guide*, page 7.

Remote Readout of the Circuit Breaker States

Remote readout of the circuit breaker status is accessible by ComPacT NSX circuit breakers equipped with a BSCM Modbus SL/ULP module. The following data is available using the communication network:

- Open/closed position (OF)
- Trip indicator (SD)
- Electrical fault indicator (SDE)

For more information, refer to DOCA0187•• *ComPacT NSX - Circuit Breakers and Switch-Disconnectors 100–630 A - User Guide*, page 7.

Remote Readout of the Measurements

Access the measurement readout with MicroLogic 5, 6, and 7 trip units.

For more information about measurements, refer to the metering function, page 106.

Remote Readout of the Operating Assistance Information

Access the operating assistance readout with MicroLogic 5, 6, and 7 trip units. The following operating assistance information is available:

- Protection settings, page 55
- Alarm settings, page 140
- History and tables of time-stamped events, page 169
- Maintenance indicators, page 170

Circuit Breaker Remote Control

The circuit breaker remote control is accessible by any circuit breaker with a MicroLogic trip unit, a BSCM Modbus SL/ULP module, and a communicating motor mechanism. The following commands are available using the communication network:

- Circuit breaker opening
- Circuit breaker closing
- Circuit breaker reset

For more information, refer to DOCA0187** *ComPacT NSX - Circuit Breakers and Switch-Disconnectors 100–630 A - User Guide*, page 7.

History and Time-Stamped Information

History

MicroLogic trip units generate the following types of history:

- History of alarms associated with measurements (the last 10 alarms are recorded)
- History of trips (the last 18 trips are recorded)
- History of maintenance operations (the last 10 operations are recorded)
- History of earth-leakage protection settings (present and previous settings recorded)
- History of earth-leakage protection tests. Tests with trip and tests without trip are recorded in the same history (the last 10 operations are recorded)

Availability

Consult the history:

- With EcoStruxure Power Commission software
- On a remote controller using the communication network

Time-Stamped Information

Time-stamped information displays dates for important information such as previous protection settings and minimum/maximum current, voltage, and network frequency values.

The table of time-stamped information describes:

- The previous protection configurations and corresponding dates
- The minimum and maximum voltage measurement values and corresponding dates
- The maximum current measurement values and corresponding dates
- The minimum and maximum network frequencies and corresponding dates

The time when the minimum and maximum values were reset is also available.

Maintenance Indicators

BSCM Modbus SL/ULP Counters

The counters embedded in the BSCM Modbus SL/ULP module generate information relating to the number of volt-free contact operations. These volt-free contacts qualify:

- The number of open/close operations (OF contact) and open on a fault operations (SD and SDE contacts) on the ComPacT NSX circuit breaker
- The number of close, open, and reset operations on the motor mechanism

MicroLogic Trip Unit Counters

Access the maintenance counters embedded in the MicroLogic trip unit with the communication network.

- Counters are assigned to each type of protection:
 - Long-time protection
 - Short-time protection
 - Instantaneous protection
 - Ground-fault protection
 - Earth-leakage protection
 - Jam motor protection
 - Phase unbalance protection
 - Long-start motor protection
 - Underload motor protection
- Ten counters are assigned to the alarms associated with measurements. These counters reset if the alarm is reconfigured.
- One counter indicates the number of operating hours. This counter is updated every 24 hours.
- Four counters are assigned to the load profile: Each counter counts the number of operating hours per loading section (for example, one counter indicates the number of operating hours for the loading section 50–79% of I_n).
- Six counters are assigned to the temperature profile: each counter counts up the number of operating hours per temperature section (for example, one counter indicates the number of operating hours for the temperature section 60–74 °C (60–165 °F)).
- Use maintenance counters to enter quantitative information about operations performed on the MicroLogic trip unit (such as the number of push-to-trip tests) or the status of the MicroLogic trip unit (such as the number of **Err** screens or protection setting lock/unlock operations).
- One counter indicates the amount of wear on the circuit breaker contacts as a percentage. When this figure reaches 100%, the contacts must be changed.

Appendices

What's in This Part

Additional Characteristics 172

Additional Characteristics

What's in This Chapter

ComPacT NSX100-250 - Distribution Protection	173
ComPacT NSX100-250 - Motor-Feeder Protection	174
ComPacT NSX400-630 - Distribution Protection	175
ComPacT NSX400-630 - Motor-Feeder Protection	176
ComPacT NSX100-630 - Reflex Tripping	177
ComPacT NSX100-630 - Limitation Curves	178

ComPacT NSX100-250 - Distribution Protection

MicroLogic 5.2 E, 6.2 E , and 7.2 E Trip Units

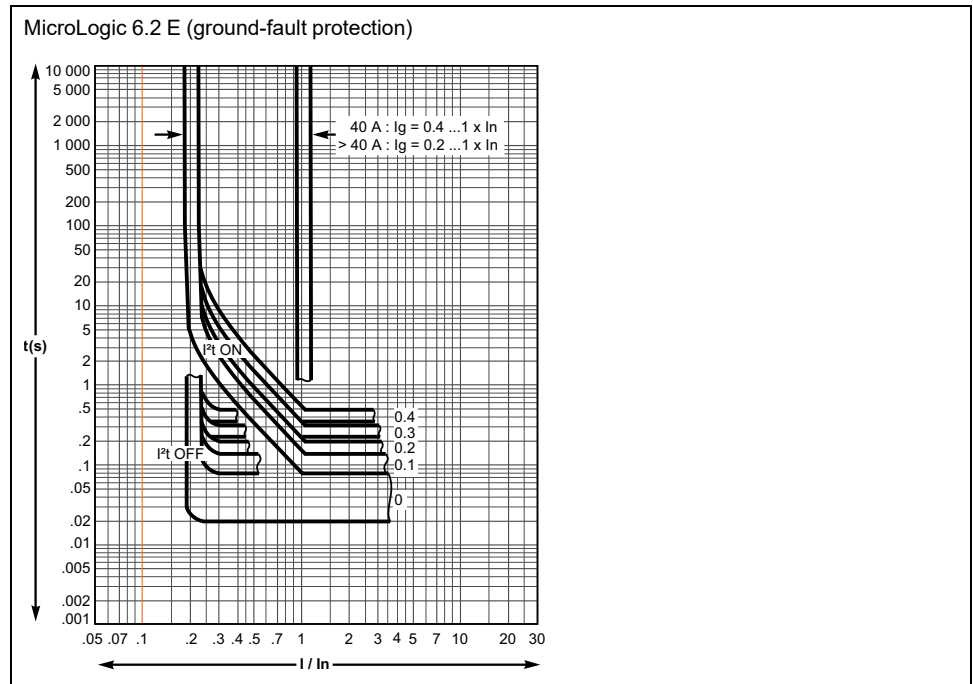
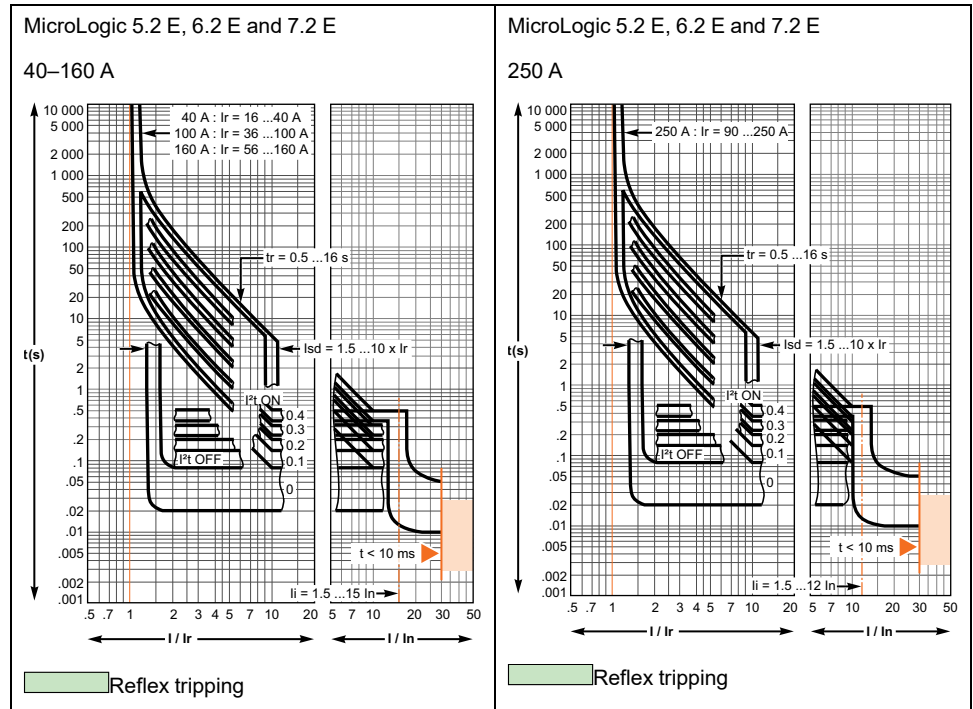

ComPacT NSX100-250 - Motor-Feeder Protection

MicroLogic 6.2 E-M Trip Units

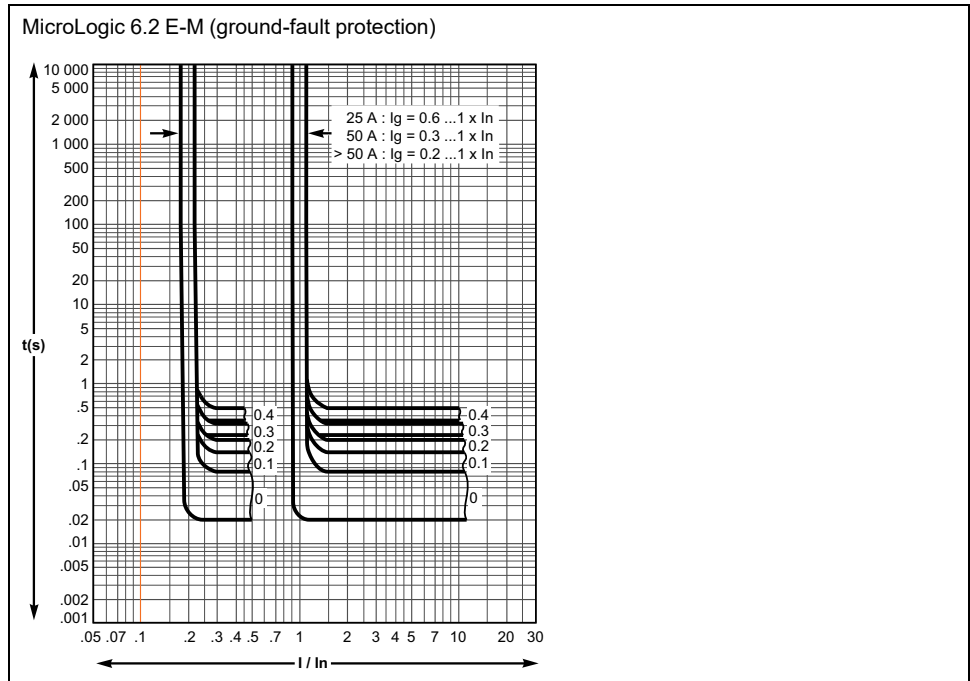
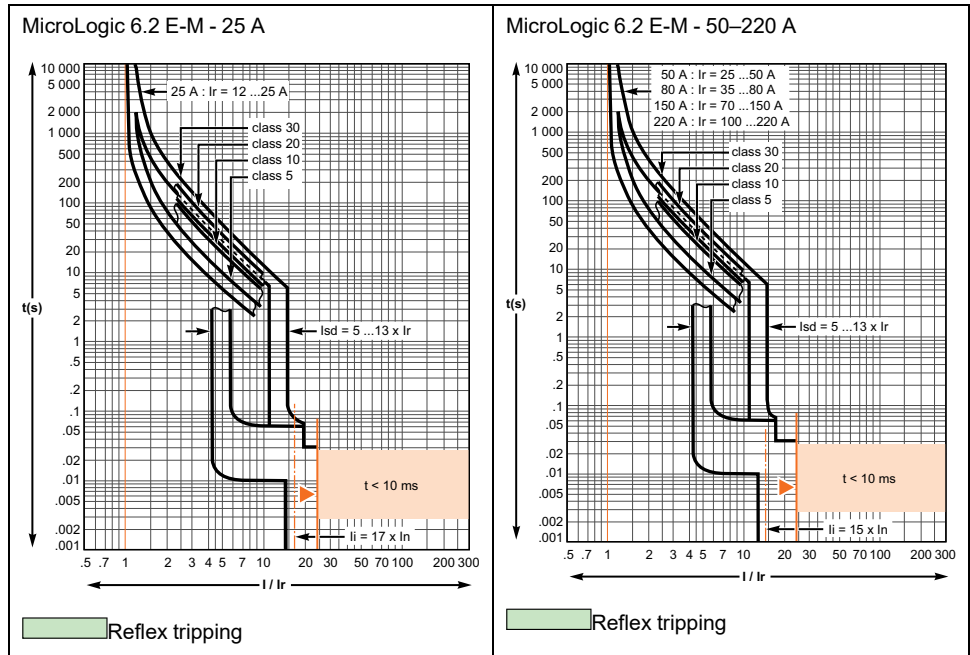

ComPacT NSX400-630 - Distribution Protection

MicroLogic 5.3 E, 6.3 E, and 7.3 E Trip Units

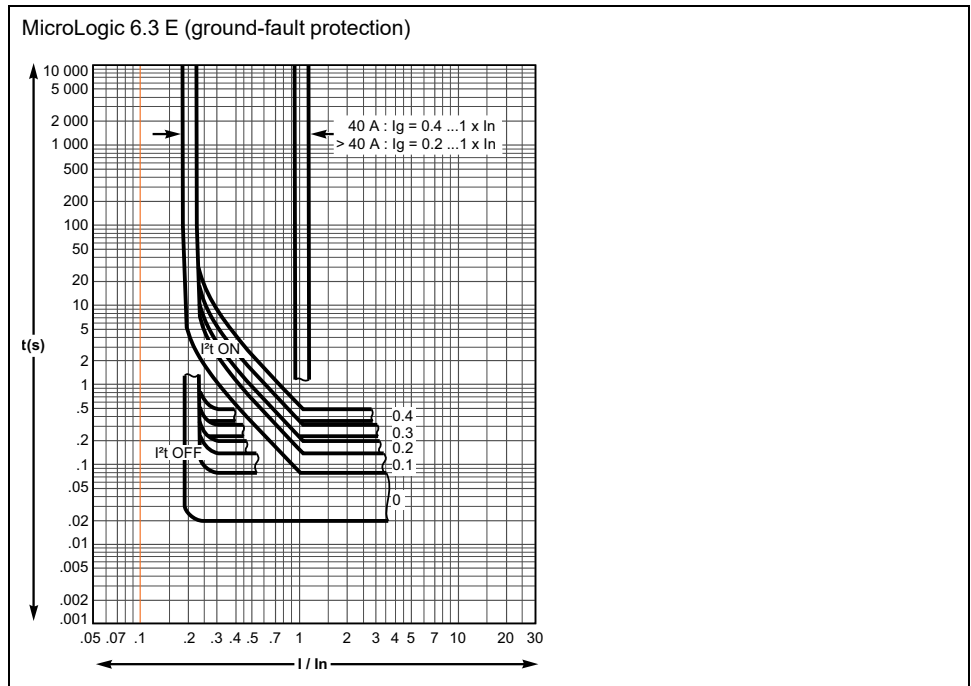
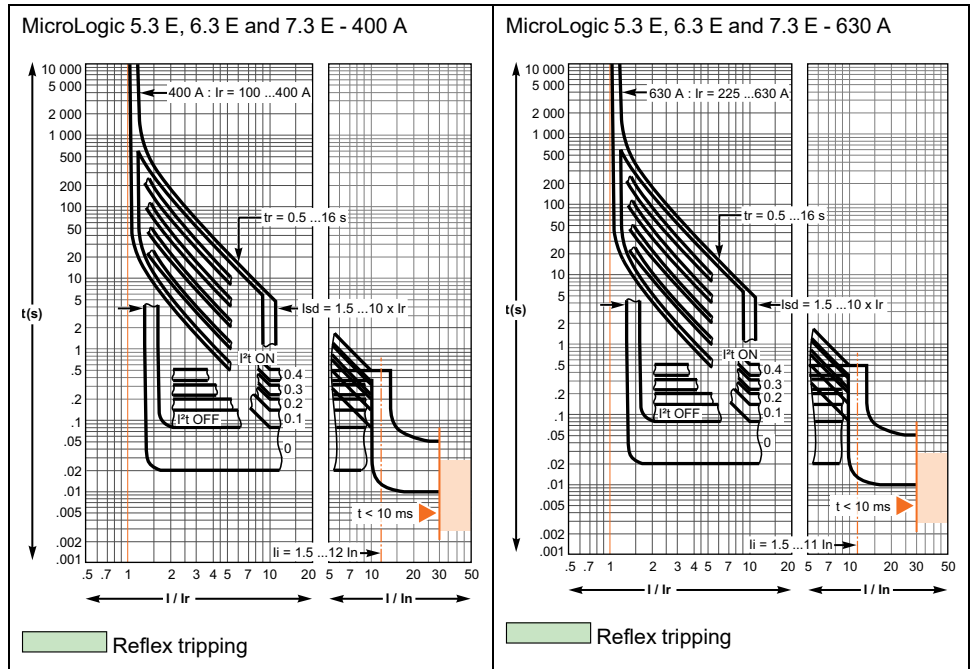

ComPacT NSX400-630 - Motor-Feeder Protection

MicroLogic 6.3 E-M Trip Unit

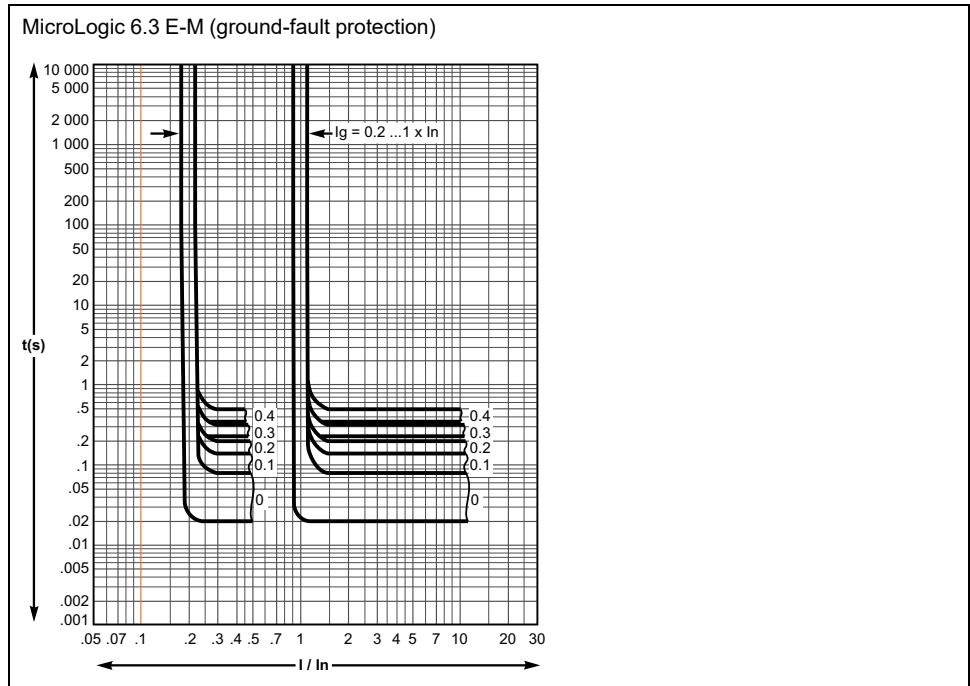
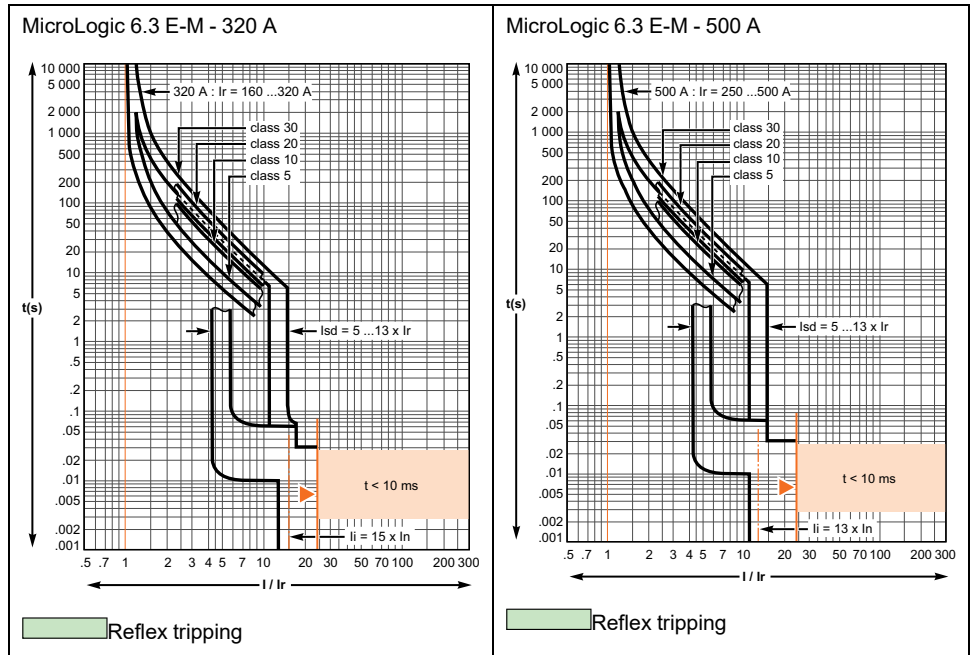

ComPacT NSX100-630 - Reflex Tripping

Presentation

ComPacT NSX devices incorporate the exclusive reflex-tripping system.

This system breaks very high fault currents.

The device is mechanically tripped via a “piston” actuated directly by the short-circuit.

For high short-circuits, this system provides a faster break, thereby ensuring selectivity.

Reflex-tripping curves are exclusively a function of the circuit breaker rating.

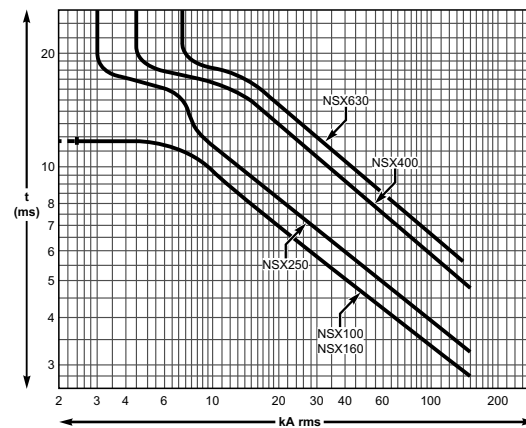

ComPacT NSX100-630 - Limitation Curves

Presentation

The limiting capacity of a circuit breaker is its aptitude to let through a current, during a short-circuit, that is less than the prospective short-circuit current.

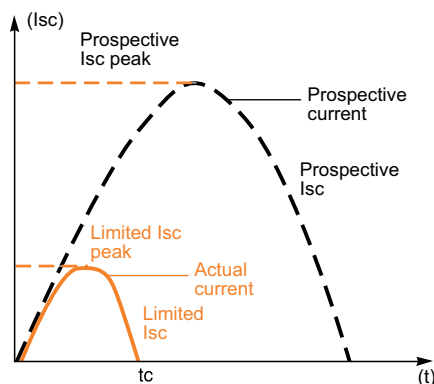

The exceptional limiting capacity of the ComPacT NSX range is due to the rotating double-break technique (very rapid natural repulsion of contacts and the appearance of 2 arc voltages in-series with a very steep wave front).

Ics = 100% Icu

The exceptional limiting capacity of the ComPacT NSX range greatly reduces the forces created by fault in devices.

The result is a major increase breaking performance.

In particular, the service breaking capacity Ics is equal to 100% of Icu.

The Icu value, defined by standard IEC/EN 60947-2, is guaranteed by tests comprising the following steps:

- Break the three times consecutively a fault current equal to 100% of Icu
- Check that the device continues to function normally, that is:
 - it conducts the rated current without abnormal temperature rise.
 - protection functions perform within the limits specified by the standard.
 - suitability for isolation is not impaired.

Longer Service Life of Electrical Installations

Current-limiting circuit breakers greatly reduce the negative effects of short-circuits on installations.

- Thermal effects:
Less temperature rise in conductors, therefore longer services life for cables.
- Mechanical effects:
Reduces electrodynamic forces, therefore less risk of electrical contacts, or busbar being deformed or broken.
- Electromagnetic effects:
Fewer disturbances for measuring devices located near electric circuits.

Economy by Means of Cascading

Cascading is a technique directly derived from current limiting. Circuit breaker with breaking capacities less than the prospective short-circuit current may be installed downstream of a limiting circuit breaker. The breaking capacity is reinforced by the limiting capacity of the upstream device. It follows that substantial savings can be made on downstream equipment and enclosures.

Current and Energy Limiting Curves

The limiting capacity of a circuit breaker is expressed by two curves which are a function of the prospective short-circuit current (the current which would flow if no protection devices were installed):

- The actual peak current (limited current)
- Thermal stress (A²s), that is, the energy dissipated by the short-circuit in a condition with a resistance of 1 Ω.

Example:

What is the real value of a 150 kA rms prospective short-circuit (that is, 330 kA peak) limited by an NSX250L upstream?

The answer is 30 kA peak, page 180.

Maximum Permissible Cable Stresses

The following table indicates the maximum permissible thermal stresses for cables depending on their insulation, conductor (Cu or Al), and their cross-sectional area (CSA). CSA values are given in mm² and thermal stresses in A²s.

CSA	Conductor	1.5 mm ²	2.5 mm ²	4 mm ²	6 mm ²	10 mm ²
PVC	Cu	2.97x10 ⁴	8.26x10 ⁴	2.12x10 ⁵	4.76x10 ⁵	1.32x10 ⁶
	Al	–	–	–	–	5.41x10 ⁵
PRC	Cu	4.1x10 ⁴	1.39x10 ⁵	2.92x10 ⁵	6.56x10 ⁵	1.82x10 ⁶
	Al	–	–	–	–	7.52x10 ⁵

CSA	Conductor	16 mm ²	25 mm ²	35 mm ²	50 mm ²
PVC	Cu	3.4x10 ⁶	8.26x10 ⁶	1.62x10 ⁷	3.31x10 ⁷
	Al	1.39x10 ⁶	3.38x10 ⁶	6.64x10 ⁶	1.35x10 ⁷
PRC	Cu	4.69x10 ⁶	1.39x10 ⁷	2.23x10 ⁷	4.56x10 ⁷
	Al	1.93x10 ⁶	4.7x10 ⁶	9.23x10 ⁶	1.88x10 ⁷

Example:

Is a Cu/PVC cable with a CSA of 10 mm² adequately protected by an NSX160F? The table above indicates that the permissible stress is 1.32x10⁶ A²s.

All short-circuit currents at the point where an NSX160F (I_{cu} = 35 kA) is installed are limited with a thermal stress less than 6x10⁵ A²s.

Cable protection is therefore ensured up to the limit of the breaking capacity of the circuit breaker.

Current-limiting Curves

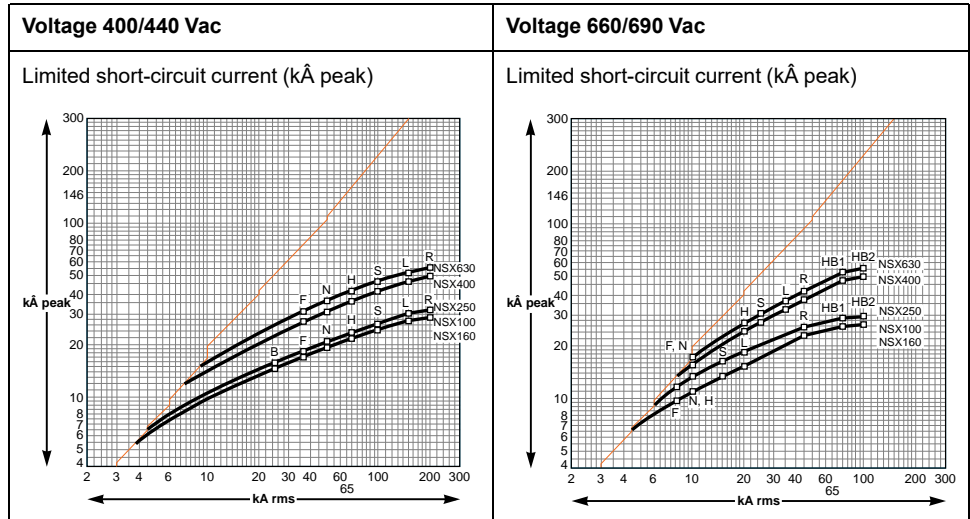

Energy-limiting Curves

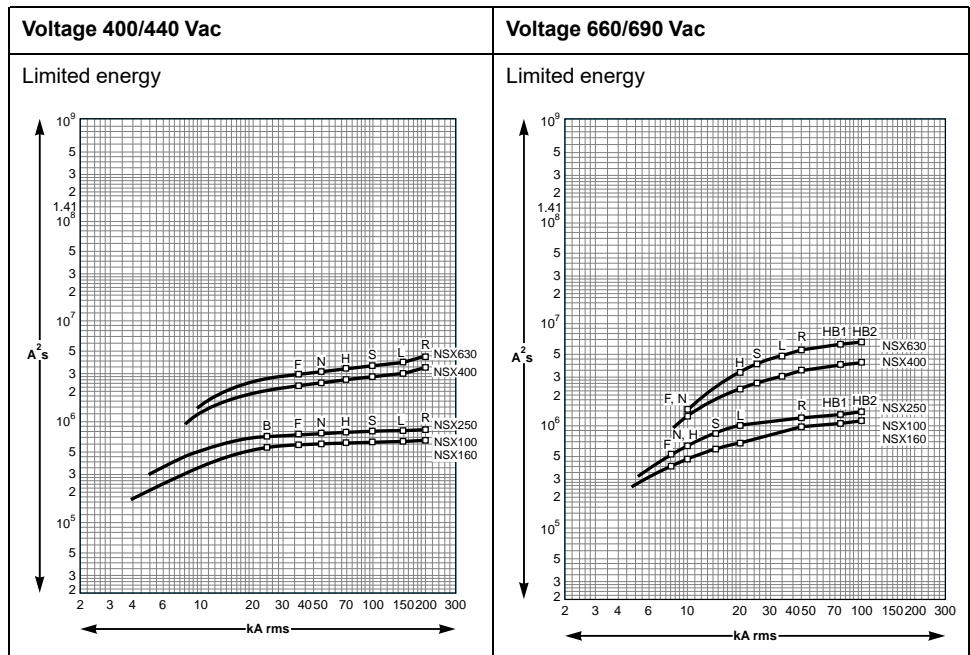

Schneider Electric
35 rue Joseph Monier
92500 Rueil Malmaison
France

+ 33 (0) 1 41 29 70 00

www.se.com

As standards, specifications, and design change from time to time,
please ask for confirmation of the information given in this publication.

© 2022 – 2024 Schneider Electric. All rights reserved.

DOCA0188EN-03