

2018 Catalog



# Easergy T300

Remote Terminal Unit

Feeder Automation

[easergy.schneider-electric.com](http://easergy.schneider-electric.com)

Life Is On

**Schneider**  
Electric



# General Contents

---

General presentation 6

---

Functions and description 18

---

Cabinet and Smart RMU Solution 98

---

Accessories 106

---

Schneider Electric Service 112

---

Commercial references 116

---

# Answer the challenges of today. And tomorrow.

Electrical distribution networks must transition to next-generation technology in order to face the challenges of modern grid applications, such as growing energy demand, stricter CO<sub>2</sub> emission limits, and tight constraints on operational expenditure (OpEx).



## Grid evolution

Support the integration of distributed energy resources (DER) and electric vehicles (EVs).

## Downtime tolerance

Minimize power supply interruptions and manage increasing energy demand.

## Quality requirements

Ensure grid performance meets customer and regulatory needs.

## Cost optimisation

Maintain aging infrastructure while expanding installations and operations.

## Need for efficiency

Manage base and peak load consumption effectively.

## Cyber threats

Comply with the latest standards and help protect your business from cyber attacks.

Easergy feeder automation solutions can help any distribution network answer these challenges.

# The new benchmark in distribution network automation

One modern Feeder RTU to answer your evolving challenges and prepare your business for the future.



The Easergy T300 Feeder RTU is compliant with IEC 62351 and IEEE 1686 standards.

It offers SCADA communication security and a role-based access control (RBAC) system to help protect your electrical infrastructure from cyber attacks.

Easergy T300

## **Evolve with the grid:** manage bidirectional and intermittent power flow

- Detect overcurrent faults including grid with interconnected distributed energy resource units
- Detect broken conductors and voltage loss

## **Increase availability:** improve SAIDI and optimize MV and LV networks

- Detect medium-voltage (MV) faults by current and voltage measurements to reduce outage time
- Reconfigure the network automatically after a MV fault (in centralized, semicentralized or decentralized approaches)
- Reduce low-voltage (LV) outage durations by blown fuse detection

## **Maintain quality:** deliver MV and LV stability

- Accommodate demand growth
- Measure MV and LV voltage accurately for Volt-Var optimization
- Detect neutral cut out at transformer level

## **Manage costs:** reduce installation, operation, and maintenance expenditures

- Optimize investment with modular automation solutions
- Enable remote and local operation and asset management including firmware update
- Save cost on spare parts, training, and operation of personnel by using a single platform for multiple applications
- Monitor transformer and substation

## **Deliver efficiency:** optimize networks to manage growing consumption

- Monitor transformers and substations to optimize asset management
- Reduce both technical and non-technical losses
- Manage load shedding and peak shaving

## **Improve cyber security:** defend against malicious software and unauthorized access

- Compliance with IEC 62351 and IEEE 1686
- SCADA communication security and Wi-Fi access

# General presentation

# General presentation

---

<b>Main applications</b>	<b>8</b>
<hr/>	
<b>Applications</b>	<b>10</b>
Network control applications	10
Typical applications	11
<hr/>	
<b>Product overview</b>	<b>12</b>
Modules	12
Configurable solutions	15
Installation and update	16
Lifecycle tools	17

---

## Utilities

DM101317

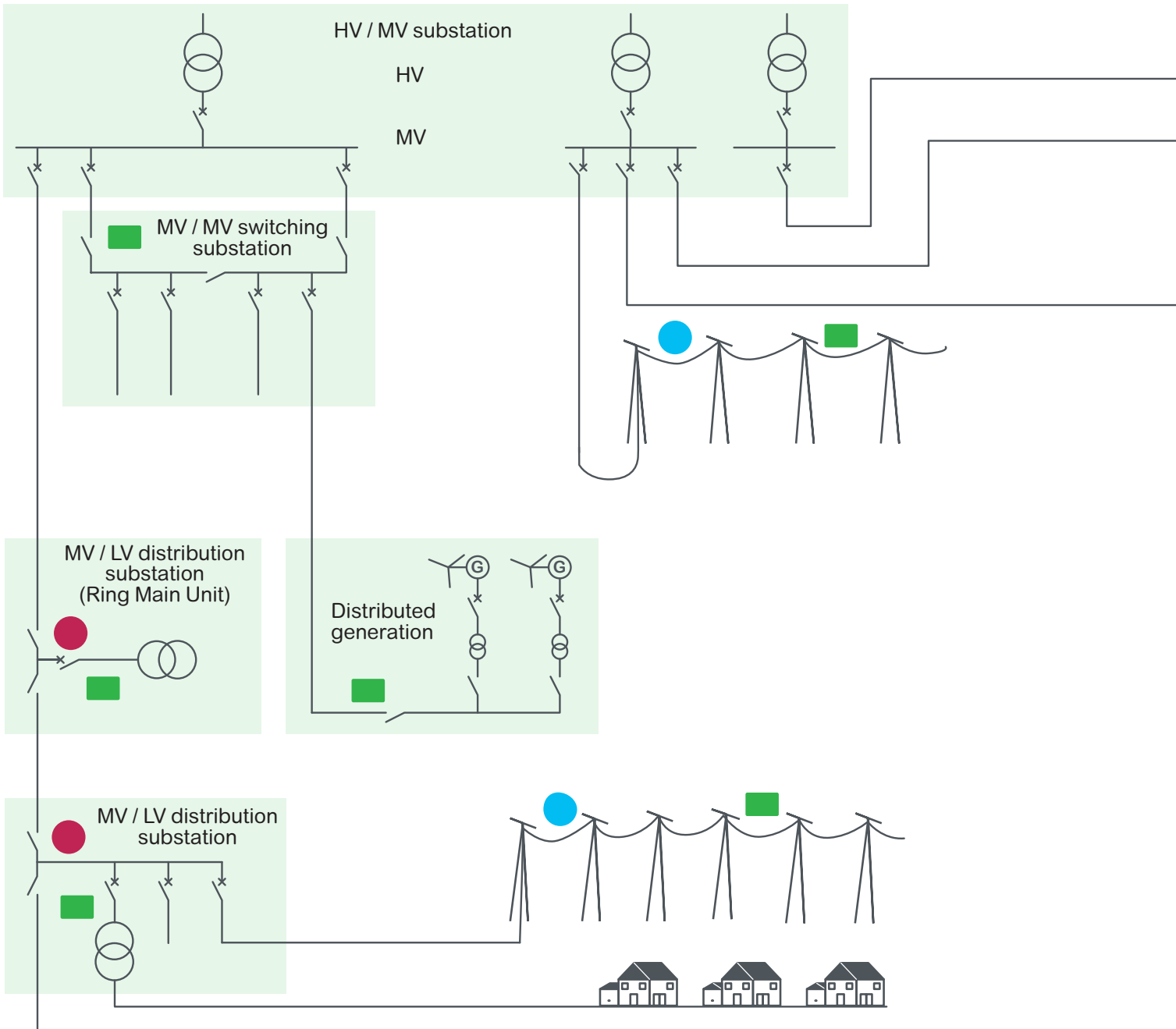



# Main applications

## Buildings & Industry

MV / LV consumer substation double feeder

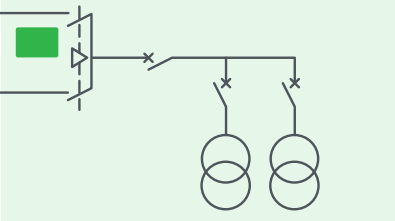

Easergy T300

MV / LV consumer substation loop connection

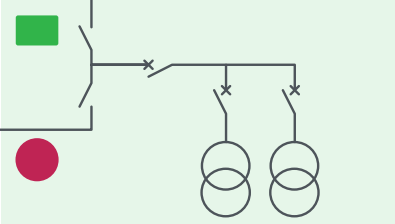

SC10773



Easergy Flite

MV / LV consumer substation with MV backup

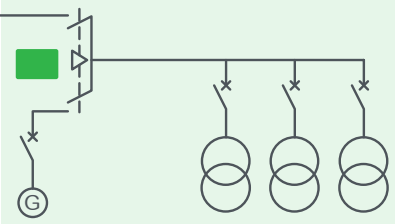

PE415848



Easergy Flair

Operating an electrical distribution grid is an increasingly complex business. The challenges posed by growing demand, integration of distributed generation resources, and aging infrastructure – to name just a few – each affect overall grid reliability and customer satisfaction.

Grid operators face these challenges in order to boost efficiency, help protect their customers and avoid regulatory scrutiny, but it's not easy.

Deployment of network controls that require large capital expenditures is problematic. Also problematic is the speedy replacement or motorizing of existing, outdated substations.

Therefore, an efficient control and monitoring solution must improve power availability, voltage management and asset management.

DM101314

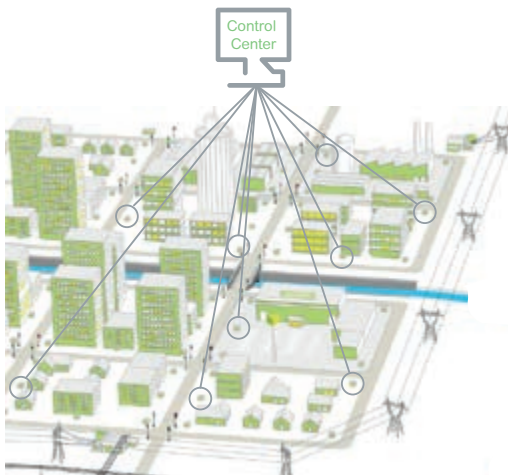

Classical remote control and monitoring

### Classical remote control and monitoring

- Scada/DMS or OMS integration for remote control and monitoring
- Real-time load monitoring of up to 24 MV feeders
- MV Fault detection signalization for centralized network reconfiguration
- Decentralized automation such as sectionalized or auto source transfer
- MV voltage measurement according to EN50160 for Volt/Var optimization support
- LV voltage monitoring and blown fuse detection
- Asset management

DM101315



Decentralized network management (FDIR)

### Decentralized network management (FDIR)

- High speed fault detection, isolation and restoration (self healing reconfiguration)
- Distant Auto Transfer Source for critical power load
- Open automation scheme based on IEC 61131-3
- Flexible and more secure peer-to-peer communication based on DNP3
- Can be associated with remote control system
- Remote configuration and firmware updates

# Applications

## Easergy T300 typical applications

Easergy T300 is a modular platform, hardware, firmware, and an application building block for Medium Voltage and Low Voltage public distribution network management. It offers a single solution for controlling and monitoring, from a simple pole-top device to a large MV/MV or MV/LV substation.

With its flexible approach, Easergy T300 provides optimized solutions for many controlling or monitoring distribution applications. Typical applications include:

### MV/LV kiosks and chamber substations

DM103463

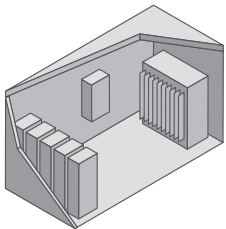

- MV control
- MV automation
- MV current fault detection
- MV & LV broken conductor detection
- LV monitoring
- Volt Var optimization support

### Pole top application Load Break Switch controller

DM103464

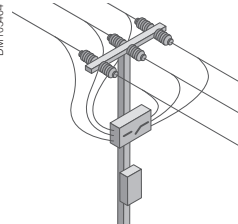

- Load break switch monitoring and control
- MV current fault detection
- MV broken conductor detection
- Volt Var optimization support

### Pole top and pad mounted transformer monitoring

DM103466

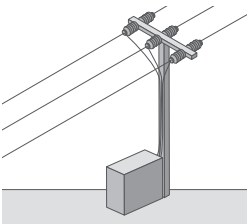

- MV and LV broken conductor detection
- Blown fuse detection
- Transformer monitoring
- LV load flow monitoring
- Volt Var optimization support

### LV distribution networks

DM103465

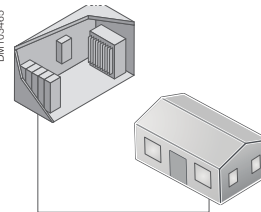

- LV broken conductor detection
- Neutral cutout
- Load monitoring
- Theft detection
- Volt Var optimization support

### Distributed Energy Resources grid connection monitoring and control

DM103467

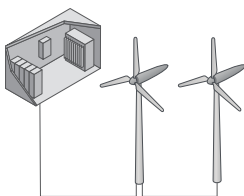

- Protection relay connection according to IEC 61850
- Utilities interface
- MV incomer control
- Volt Var optimization support

### MV Line and end of line monitoring

DM103462

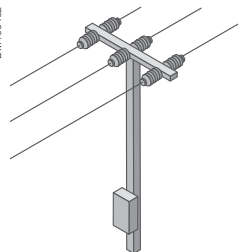

- MV broken conductor detection
- MV fault detection
- Volt Var optimization support

# Product overview

Easergy T300 is modular and application-oriented.

This open architecture supports different applications, from a single communication gateway to large substation management with third-party devices.

DM103468b

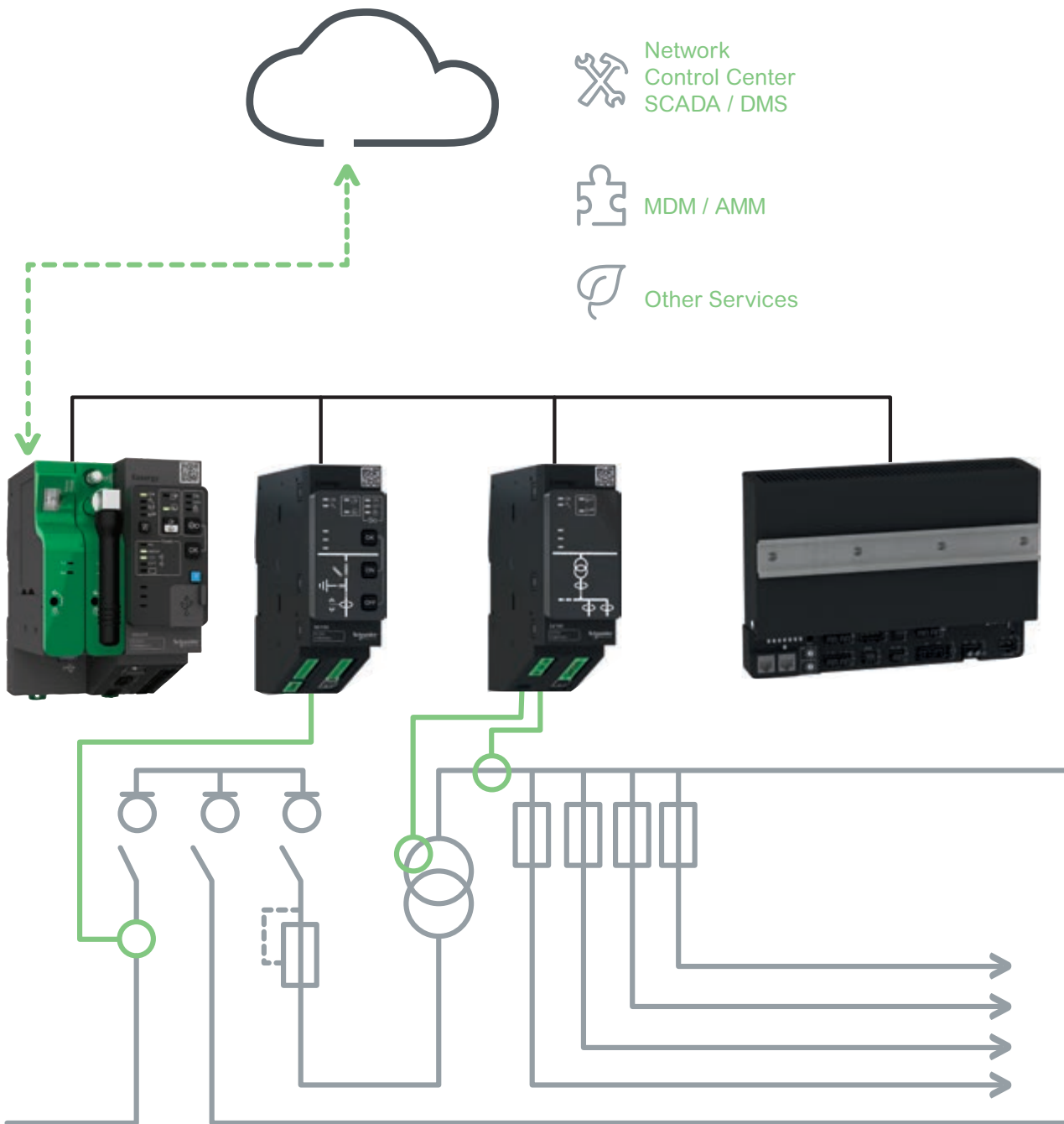

The modules, with their supported applications, are:



## Easergy HU250 – Head Unit communication gateway

- IEC 61850 data model
- Flexible communication to control center and other customer IT applications
  - Standard and security-focused protocols: IEC 101/104, DNP3, IEC 61850, Modbus
  - Open peer-to-peer communication to self-healing application
  - Flexible communication media (Ethernet, USB, GPRS, 2G, 3G, 4G)
- Cyber security management
- Open to third-party devices with many protocol capabilities
- Built-in webserver for commissioning and maintenance with local and remote access, compatible with PC, tablet and smartphone devices
- Embedded IEC 601131-3 PLC for automation design



## Easergy SC150 – Switch controller

- IEC 61850 data model
- Control and monitoring of all switchgear types
- Advanced Fault Passage Indicator (FPI) algorithms:
  - Phase-phase and phase-ground detection ANSI 50/51, 50N/51N
  - Directional phase-phase and phase-ground detection ANSI 67/67N
  - Broken conductor detection (one phase lost) ANSI 47
- MV Voltage monitoring ANSI 27, 59, 59N
- MV Current monitoring ANSI 37
- Large current and voltage measurement capabilities: standard CT for current, LPVT, VT, VDS, VPIS and capacitor interface for voltage
- Current and voltage measurement according to IEC 61557-12
- Power quality according to IEC 61000-4-30 class S:
  - Specific application automation: sectionalizer



## Easergy LV150 – Transformer and Low Voltage monitoring

- IEC 61850 data model
- Transformer temperature measurement and monitoring
- Voltage, current and power measurement according to IEC 61557-12
- Broken conductor detection (one phase lost MV or LV) ANSI 47
- LV Voltage monitoring ANSI 27, 59, 59N
- Power quality according to IEC 61000-4-30 class S



## Easergy PS25 and Easergy PS50 – Power Supply for control and monitoring solutions

Two back-up power supplies are available in the catalog:

- PS25 for monitoring solution with only one voltage output (12 Vdc or 24 Vdc)
- PS50 is a harsh environment power supply for MVLV substation control with power supply for:
  - Switch control: 48 Vdc or 24 Vdc
  - Telecom devices: 12 Vdc
  - Easergy T300: 12 Vdc.

Easergy T300 is a powerful feeder RTU delivering three configurable solutions to fit your exact needs.

Choose from ready-to-use solutions, tailored integrations, or those for substation retrofits.

All Easergy T300 modules offer DIN rail mounting for flexible RTUs integration design. Many accessories and sensors, available in the catalog, allow fast integration in any kind of application.



## Ready-to-use solution

A variety of ready-to-use solutions are available off-the-shelf for fast delivery and installation, and are also available for retrofit.

The Easergy T300 configurator allows you to quickly build your RTU configuration (hardware and software).

You can consult our engineering centers to design or customize a dedicated solution.

Three types of enclosure are available as standard, depending on the installation environment:

- Indoor controller cabinet
- Outdoor controller cabinet, wall mounting or pole mounting
- Indoor and outdoor monitoring, wall mounting or pole mounting



## Smart seamless integration of RMU and RTU

The smart ring main unit (smart RMU) is an innovative solution that makes it easier for you to answer the evolving challenges of secondary electrical distribution.

Building on our proven RMUs – the RM6, FBX, and Ringmaster, Schneider Electric's smart RMUs are seamlessly integrated with the Easergy T300.

Customizable to your needs, the smart RMU offers a wide range of basic and advanced capabilities.



## Open solution

A completely tailored and configured solution can be designed by Schneider Electric engineering centers to meet specific needs.

- New enclosure
- Retrofit in existing cabinet

# Product overview

Fast and easy installation and update in one click without dedicated tools.

HU250, SC150 (x3) and LV150

mounted on PS50 with friendly HMI for local operation

2 flexible communication modem boxes

PS50

in background with voltage output and battery connector

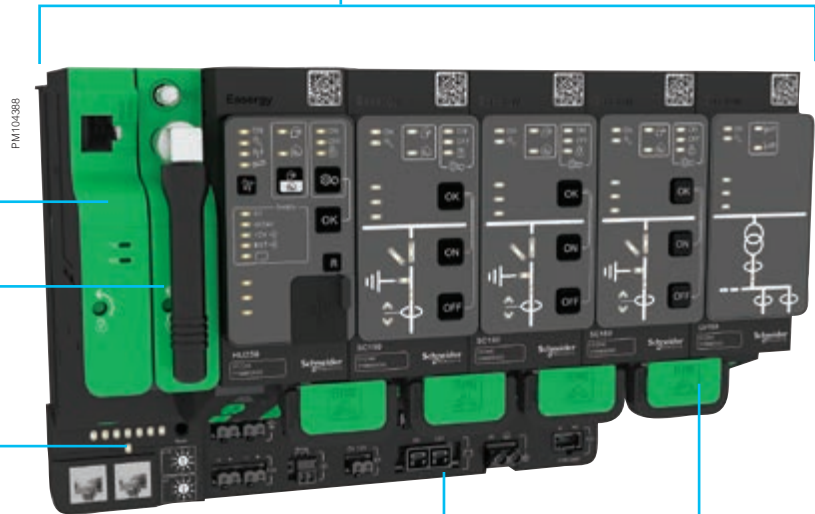

Removable connectors

for switchgear interface and sensors

Ethernet jumper

between modules for quick installation and update

## Easergy T300 benefits

- Easy and fast ordering and delivery
- Ease of installation and commissioning
- Very small foot-print for small substations and switchgear cabinets
- Flexible solution adapted to your requirements
- One hardware and software platform for all applications
- Easy on-site updating



Easergy T300 offers several tools for the different stages of the lifecycle of the product.

Access is possible locally and remotely. Local access can be made by Wi-Fi or cable.

Easergy T300 is supplied in a standard configuration or a dedicated customer configuration.

Commissioning and maintenance do not require special tools, only a web browser on a PC, tablet or smartphone.

## Easergy Builder for engineering teams

Easergy Builder is used by expert engineering teams to modify or design new databases off line:

- Import new automation designed in IEC 61131-3 PLC workshop
- Configure new communication channels
- Integrate new third part IEDs
- Design new databases

## Embedded web server for commissioning, exploitation and maintenance

The operations from the web server, according to the defined level of access, are:

- View the status of the substation: substation view diagram, system view, events log file, measure log file, alarms
- Modify settings: Fault Passage Indicator, automation, communication
- Upload and download firmware and configuration data base
- Modify security access

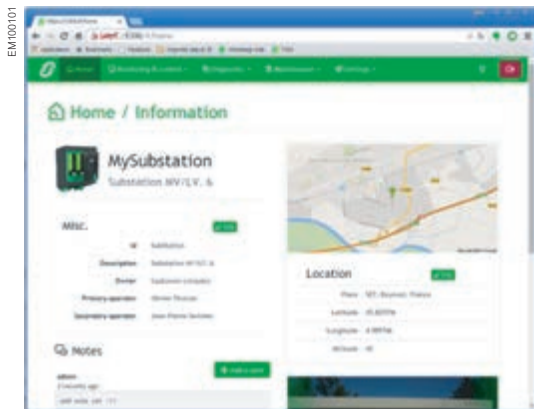
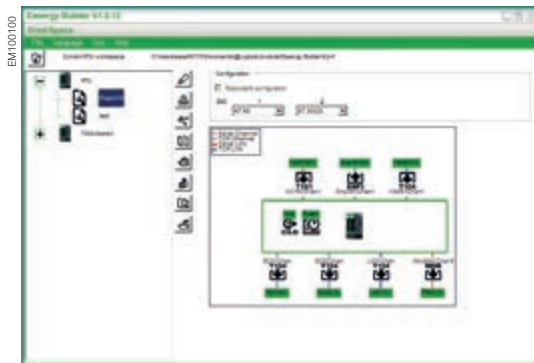

Web server

# Functions and description

# Functions and description

---

<b>Easergy HU250 Head Unit Communication</b>	<b>20</b>
General description	21
Communication ports	25
Protocols and communication architecture	26
Time synchro and sequence of events	29
Cyber security	30
Open programmable logic controller	31
Communication ports characteristics	33
Characteristics	34
Configuration tools	36
<hr/>	
<b>Easergy SC150 Switch controller</b>	<b>40</b>
General description	41
Switchgear control	45
Voltage measurement	47
Current measurement	50
Fault current detection	52
Fault Passage Indicator	57
Network monitoring	58
Sectionalizer automation	61
Characteristics	62
<hr/>	
<b>Easergy LV150 Low Voltage monitoring</b>	<b>68</b>
General description	69
Connection	72
Network monitoring	73
Characteristics	75
<hr/>	
<b>Easergy PS50 - PS25</b>	<b>82</b>
General description	83
Power supply selection guide	85
Battery autonomy	89
Characteristics	92
Installation	96

---

# Easergy HU250

## Head Unit Communication

# Easergy HU250

## Head Unit Communication

### General description

The Easergy Head Unit HU250 is the communication module of the Easergy T300.



### Easergy HU250 manages:

- Cyber security access
- Communication with control center
- Communication with other substations (peer-to-peer communication)
- Easergy T300 modules gateway
- Local network communication with third-party IEDs
- Local and remote configuration access for all modules of Easergy T300
- Web server with local and remote access
- Automation system with programmable logic control
- Global function as remote/local operation, automation enable/disable

The figure shows an example of the communication architecture and the capabilities of Easergy T300.

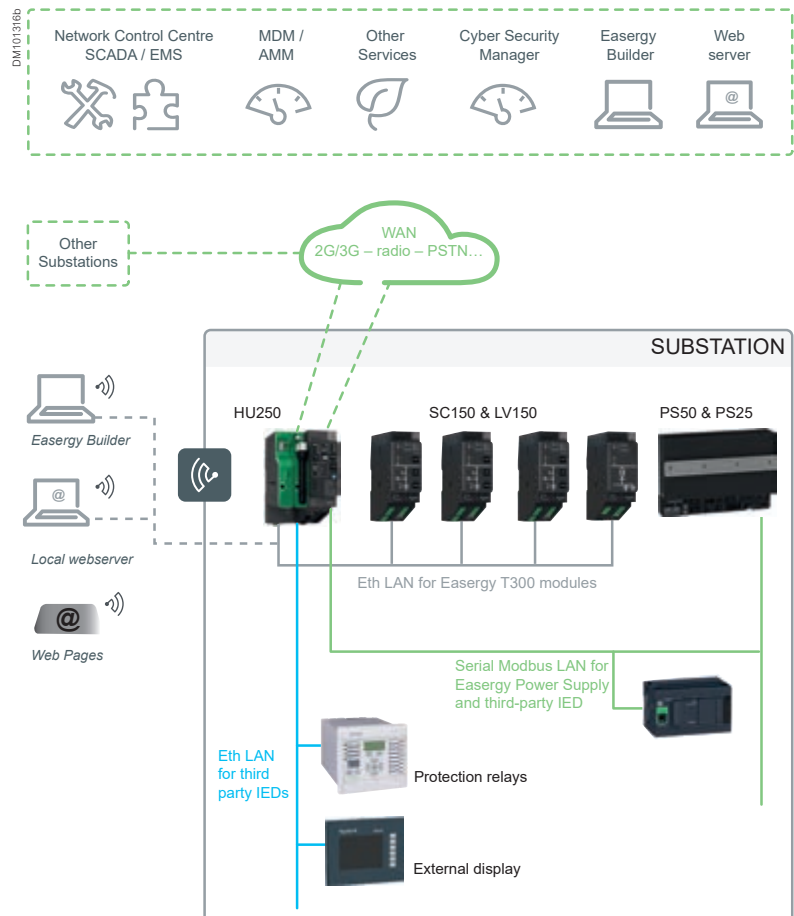

Easergy HU250 is a powerful and flexible communication gateway for all Easergy T300 configurations.

- Easergy HU250 can also be used as a standalone gateway for third-party IEDs
- Open to any communication system and protocol
- Compliant with cyber security standards
- Advanced configuration tools
- Web server for easy commissioning and maintenance
- Open to IEC 61131 applications
- Easy remote and local firmware updates
- Secure Wi-Fi connectivity

# Easergy HU250 Head Unit Communication

## General description (cont.)

### Part Number

Reference	Description
<b>HU250</b>	
EMS59000	Easergy HU250 Head Unit gateway
EMS59150	Empty modem box for HU250
<b>Modem</b>	
EMS59151	RS232-485 box for HU250
EMS59152	2G/3G modem box for HU250
EMS59154	4G US standard modem box for HU250
EMS59155	4G EU standard modem box for HU250

### Network control centers

This includes several types of remote control center from an entry-level SCADA like Easergy L500 to advanced ADMS systems.

### MDM/AMM

Meter Data Management system/Advanced Meter Management: Easergy T300 can transfer some data as Low Voltage measurements to the metering system.

### Cyber security manager

One aspect of the cyber security objective is to secure all control and data acquisition for the operation of its electric system.

The Schneider Electric SAT is a security configuration tool to define/configure the security policy of the devices. It allows to create user account with password and role allocated.

### Other services

Easergy T300 can also communicate with others services, such as field services for maintenance management, load prediction, and advanced news services.

### Easergy Builder

Easergy Builder is a PC-based engineering tool for Easergy T300 customization and design. Easergy Builder can be used locally via Wi-Fi or wired connection, or remotely via the WAN with a secure connection.

### Remote and local webserver

Remote access is available through the WAN network to embedded Easergy T300 web apps from a standard browser. This application can be used for data consultation, software update, configuration upload and maintenance.

Local access can be achieved via Wi-Fi or wired connection.

### Protection relay

The catalog of master protocol of Easergy T300 allows an ease protection relay integration with Easergy Builder engineering tool.

### External display

The Easergy T300 can also support an external HMI such as a touch cabinet or an advanced display. This integration requires a dedicated configuration using Easergy Builder and can be incorporated by Schneider Engineering on request.

### Extended I/O with PLC

An external Programmable Logic Controller can be used to extend the Easergy T300 capacity or for dedicated applications.

This integration requires the use of Easergy Builder and can be incorporated by Schneider Engineering center on demand.

# Easergy HU250 Head Unit Communication

General description (cont.)

## Local operator front panel (HMI)

The HU250 gives general information

### Local / remote control and status

- Local position: the remote switch control from the remote access is locked
- Remote position: the local switch control from local access (SC150 HMI, Wi-Fi) is locked
- A button on the HU250 enables changing the control status between local and remote. This button can be replaced by an external device

### Easergy T300 status

- HU250 heartbeat status
- T300 equipment status
- Wi-Fi status
- Communication status with modules

### LEDs test button

The test button forces all LEDs on T300 and the external lamp to ON in order to control the led.

### Power supply status

The HU250 displays the power supply status, transmitted by the power supply via Modbus.

- AC supply ON/OFF
- Voltage output for switchgear motor ON/OFF
- Voltage output for transmission devices ON/OFF
- Battery status

### Free configurable LEDs

Three free LEDs, configurable for multi-purpose status

### Automation status and control

The button with validation allows the operator to locally enable/disable the automation for all modules. The operator must simultaneously press the automation and the **OK** button.

- Automation status LEDs: ON / OFF
- Automation locked status
- Automation status and control



# Easergy HU250 Head Unit Communication

General description (cont.)

## Digital I/O substation monitoring

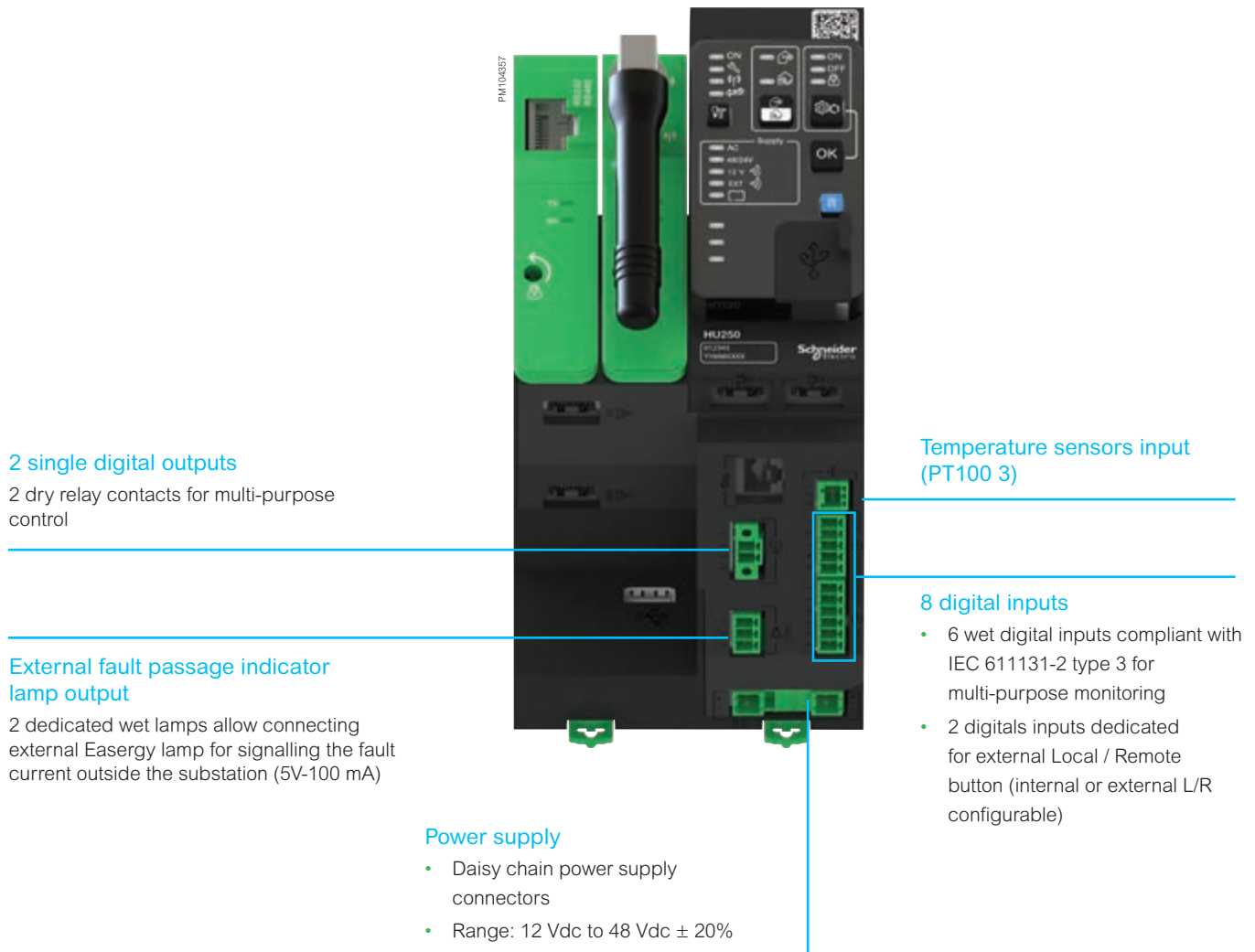



# Easergy HU250

## Head Unit Communication

### Communication ports

### Configurable communication ports

#### Wi-Fi hotspot with security for local connection

Easergy T300 incorporates an embedded Wi-Fi hotspot for local connection to:

- Embedded web server via a laptop, tablet or smart phone
- Easergy Builder

#### Flexible communication ports

These communications ports can accommodate modem boxes. These modem boxes can be added on site and make for very flexible updating during the product lifecycle. The modem boxes available are:

- RS232/485 modem box for WAN or LAN communication
- 2G/3G modem box for WAN communication
- 2G/3G modem box with GPS clocks for accurate time synchronization (\*)
- 4G European and US standard modem box with GPS clocks for accurate time synchronization

#### Ethernet ports

These ports can accommodate one of the following options:

- WAN communication
- LAN communication for third-party IEDs

#### USB port

One USB host port for multi-purpose use

#### USB port

One mini USB port dedicated for maintenance

#### Dedicated dual Ethernet port for Easergy T300 modules

This Dual Ethernet port daisy-chain is dedicated for communication between Easergy T300 modules and connection to a laptop with Easergy Builder or an internet browser for connection to a web server.

#### Serial RS485 Modbus port

This port is used for the connection to the Easergy communication power supply and can be used for third-party Modbus IEDs



### Wi-Fi management with security

- Wi-Fi activity: Enable / Disable
- Activation mode: From SCADA, Web, HMI Local / Remote button
- SSID visibility: Enable / Disable
- SSID value
- Passphrase value
- Disconnection: Automatic disconnection by timeout

# Easergy HU250 Head Unit Communication

## Protocols & communication architecture

HU250 can communicate with peers (SCADA or other devices) on one or N communication channels.

- Each communication channel can have its own channel type and protocol adapted to different usage (DMS, AMM, local automation, etc.)
- Communication channels can be created with Easergy Builder
- The T300 is delivered with default communication channels adapted to standard usage

### Protocols

Easergy T300 communicates with remote SCADA or between substations using open protocols. Easergy HU250 may also be used as data concentrators for slave devices.

Easergy HU250 can manage several communication channels and protocols at the same time.

#### IEC 60870-5-104 slave and master and IEC 60870-5-101 slave

- UDP (IEC 60870-5-101 only), TCP and Serial (RS232/485)
- Supports secure authentication according to IEC 62351-5
- Redundant connections (IEC 60870-5-104 only (3)) with several Master IPs

*For more information on the IEC 60870-5 protocol, visit [www.iec.ch](http://www.iec.ch).*

#### DNP3 slave and master

- Supports secure authentication according to IEC 62351-5
- UDP, TCP (including dual end point) and Serial (RS232/485)

*For more information on the DNP3 protocol, visit [www.dnp.org](http://www.dnp.org).*

#### Modbus slave and master

- TCP and Serial (RS232/485)

*For more information on the Modbus protocol, visit [www.modbus.org](http://www.modbus.org).*

#### IEC 61850 master and slave

- IEC 61850-8-1 ed 2 client and server

*For more information on the IEC 61850 protocol, visit [www.iec.ch](http://www.iec.ch).*

#### Others protocols

- SFTP for secure file transfer
- HTTPS for secure web server connection
- SNTP for time synchronization

# Easergy HU250 Head Unit Communication

## Protocols & communication architecture

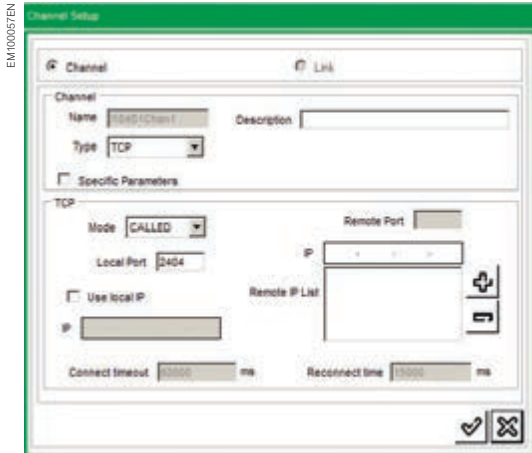

TCP channel configuration from Easergy Builder

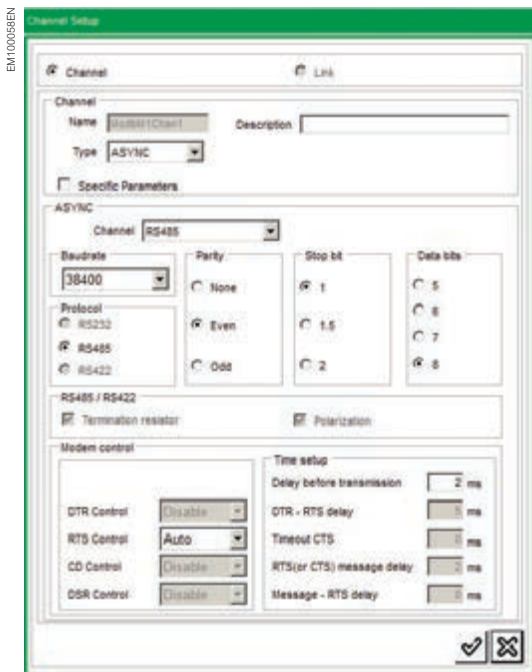

Serial channel configuration from Easergy Builder

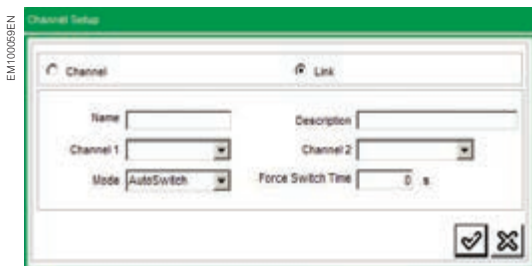

Association of channels

## Channels

The ports used to communicate are configured as communication channels. A channel can support one or more protocols according to the compatibilities with the physical layers.

The possible channels are:

- Serial (RS232/RS485)
- TCP (Called, Calling or Both) or UDP

For TCP and UDP channels, a remote IP list can be created to limit access to identified peers.

## Channel association - Links

Some control centers or IEDs support double channels. The functionality can be different for each protocol. The links are associations of two channels and they are used to identify a double channel. Two modes of channels switching are possible:

- AutoSwitch: used with slave protocols. When the active channel stops receiving, it switches to the other channel, which becomes active
- SwitchByMaster: used with the master protocol, the HU250 controls the channel switching. A periodic switching between channels can be defined in order to verify channel state TIME\_FORCE\_SWITCH

## Example of Easergy T300 communication channel

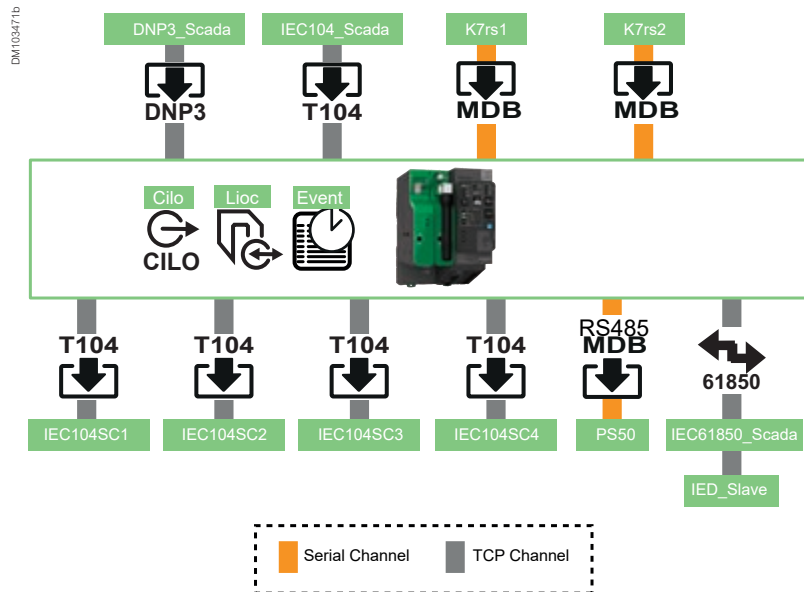

# Easergy HU250 Head Unit Communication

## Protocols & communication architecture



### One communication channel to one control center

In this case we have one transmission media and one protocol for communicating with only one control center.



### Two redundant physical channels to one control center

In this case we have two transmission media (2 channels) and one protocol for communicating with one control center.

The two channels can be grouped to create a redundant physical link with autoswitch mode.

The channel where some data are received is considered active. The HU250 always sends data on the active channel.



### Two communication channels to two control centers

Two communication channels can be used for communicating with two control centers. In this case, each channel works separately.

Each communication channel manages its own:

- Protocol and modem
- Event tables
- Mapping protocol

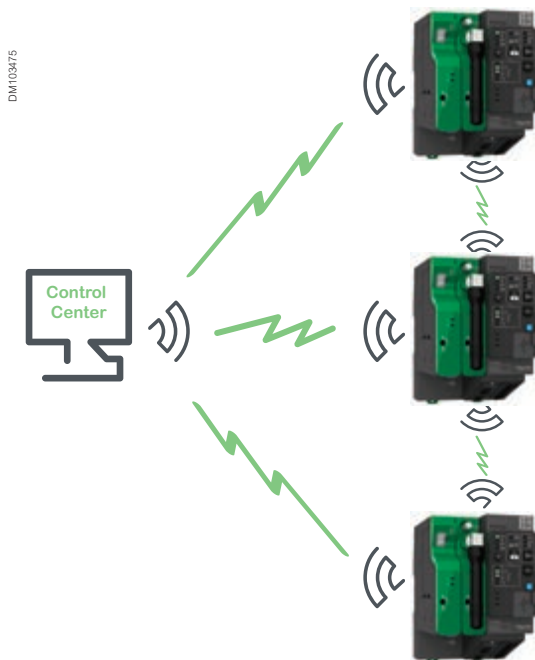

### Control center and peer-to-peer communication

Communication channels can be configured for peer-to-peer communication between multiple Easergy T300 devices.

The main applications are:

- Automatic Change Over between two remote substations
- Self-healing automation between two or more remote substations

# Easergy HU250

## Head Unit Communication

### Time synchro & sequence of events

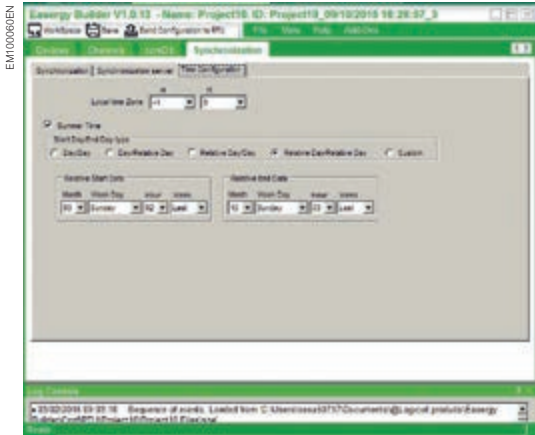

Easergy T300 can accommodate several kinds of clock synchronization and manages:

- Local time zone
- Summer/winter time

## Time synchronization

Proper time-stamping of events and alarms requires that correct time information is provided to the Easergy T300. The Easergy T300 time synchronization is managed by Easergy HU250. Time synchronization can be achieved in numerous ways, depending on the overall system architecture and the required precision.

- **Protocol:** Most data-transmission protocols allow slave devices to synchronize from a control. The time accuracy depends on the implementation and the communication media
- **SNTP or NTP:** Ethernet communication networks provide SNTP clocks to synchronize devices. Easergy HU250 can manage a list of SNTP servers: The time accuracy depends on network topology
- **GPS clock** synchronization with 4G modem GPS option.

## Easergy T300 modules time synchro

Easergy HU250 operates as a time server to synchronize:

- T300 modules using the Time Protocol (IEEE 1588)
- IEDs in the substation
  - Master Protocol
  - SNTP server

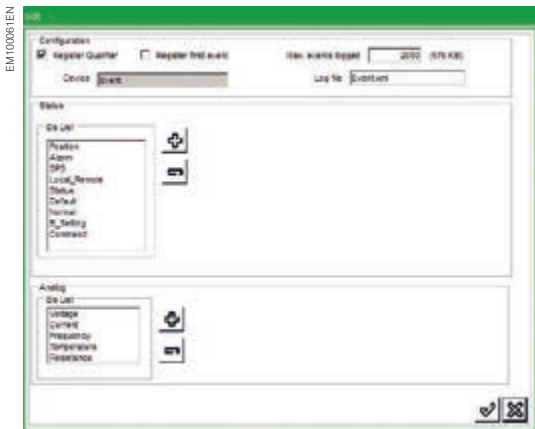

SOE configuration

## Sequences Of Events (SOE)

The Sequence Of Events (SOE) records all data changes in log files. Each Easergy T300 has its own SOE management. The recording mode for each variable can be configured from the HU250 via Easergy Builder.

- Up to 4 log files can be configured
  - These logs can be defined from Easergy Builder
  - The names of these logs are configurable
  - Any data from the database can be assigned to a log file
- The logs files may be downloaded locally from the web server and remotely by SFTP
- SOE time accuracy
- Time resolution: 1 ms
- Discrimination between 2 events: 1 ms
- Event storage capacity
  - Up to 500 000 events can be stored by Easergy T300
  - The size of logs files is configurable

For all logs, when the storage capacity is reached, the most recent event clears the oldest from the list.

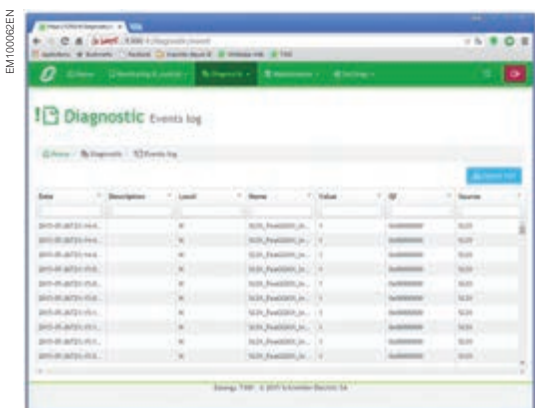

Web server view of SOE

# Easergy HU250 Head Unit Communication

## Cyber security

The purpose of cyber security is to help protect the device against unauthorized operation and to provide an audit trail of access.

Cyber security requirements are designed to meet the international cyber security standards and support the security systems necessary to fulfill NERC and IEC 62351 requirements.

According to the device location and installation, additional hardware or software may be required in order to limit access to the device and/or communication interfaces. Alarms may also be required to be sent to the control center (SCADA) when users access the device.

One of the key aspects of the cyber security is to define a security policy. This security policy structures the roles and responsibilities within the organization, and specifies who is authorized to perform what and when.

Easergy T300 supports hardening to help prevent unauthorized access:

- Authentication by centralized Radius client
- Local and remote control access security based on RBAC
- Local and remote connection security for maintenance: HTTPS, SSH
- Protocol security for file transfer: SFTP
- Protocol security for control center communication according to:
  - IEC 62351-5 for DNP3 and IEC 60870-5-104.

## Secure local and remote control access (RBAC)

The device uses Role-Based-Access-Control (RBAC) to provide defined levels of access for users. RBAC is predefined according to IEC 62351-8 but is also configurable according to user requirements:

- 15 default user accounts
- User role assignments
- Roles to access assignments

Easergy T300 is provided with a pre-defined RBAC. It can be customized with the cyber security manager tool SAT.

Easergy T300 has an internal radius Server in order to coordinate the authentication from an unique customer security policy management system.

Role	Right								
	DATA BASE	FIRMWARE	WEB Services	BUILDER	TOOLS	LOG & SOE	SECURITY	DATA	RESET
VIEWER			•					•	
OPERATOR	•		•			•		•	
ENGINEER	•	•	•	•	•	•		•	•
INSTALLER	•	•	•	•	•	•		•	•
SECADM			•				•		

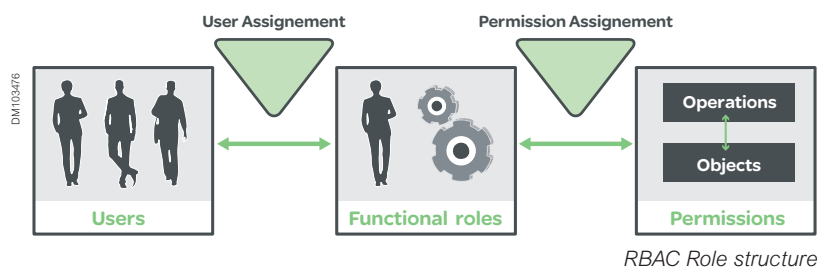

- The RBAC is configurable from the web server
  - User authentication and password management
- RBAC can be modified with the cyber security manager SAT
  - User account management (add/modify/delete user accounts)
  - Easergy T300 installed base security management
  - Reset of default factory user
- Cyber security log

Easergy T300 supports advanced logging and monitoring features for cyber security implementations. Logs are protected against unauthorized access, modification and deletion and are preserved in the security events log.

# Easergy HU250 Head Unit Communication

## Open Programmable Logic Controller

Powerful open PLC IEC 61131 software for automation design.

Easergy HU250 integrates ISaGRAF® runtime to execute the applications generated from IsaGRAF Workbench.

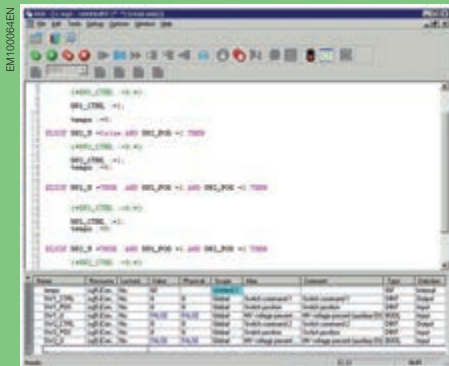
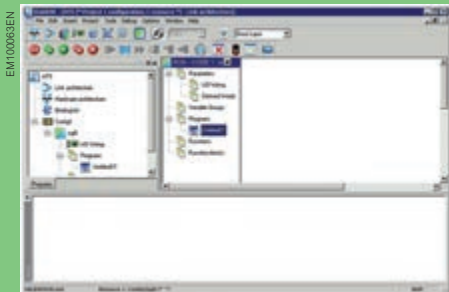

### IEC 61131-3 support

The IsaGRAF® Application Workbench provides powerful and intuitive graphical and textual editors for SFC, FBD and LD, and Text Editors for ST and IL.

All data (analog and digital) can be configured with Easergy Builder for the IEC 61131 PLC used. The IEC 61131 program can be downloaded locally or remotely on the dedicated configuration.

### Typical applications using an IEC 61131-3 program

Easergy T300 automation networks are designed in IEC 61131, except reflex automation like sectionalizers, which are managed by the SC150.

#### Local Automatic Transfer Source ATS <sup>(1)</sup>

An ATS system allows a critical load (such as a network section, a hospital or manufacturing plant) to have increased supply availability by switching between a primary and a backup supply.

- Automatically transfers between alternate supplies if one is lost
- Can be set to automatically reconfigure when the preferred supply is restored

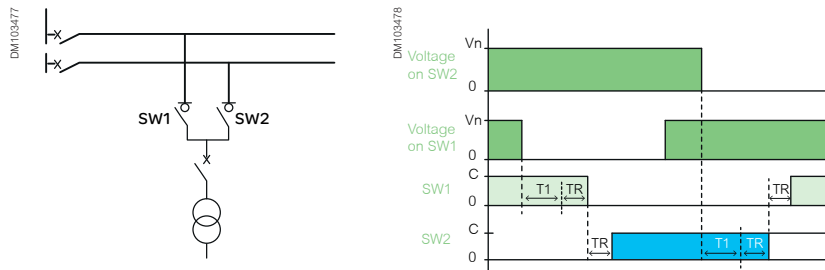

#### Distributed Automatic Transfer Source <sup>(1)</sup>

The principle is the same as local ATS with a peer-to-peer communication between two distant underground substations or overhead LBS.

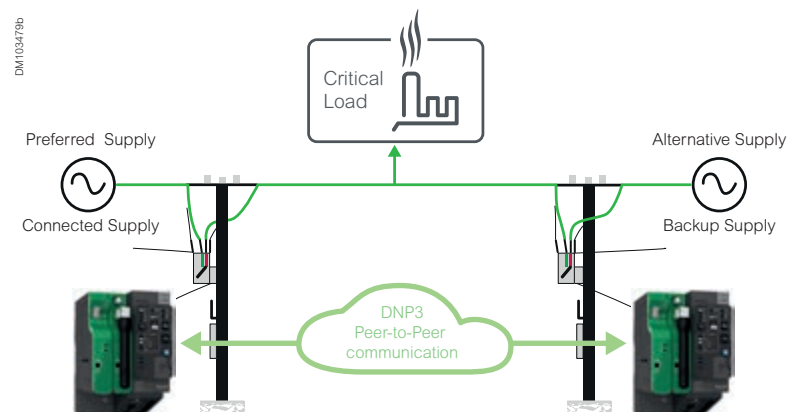

(1) Available on project, consult us

Language	Type of application
Sequential Function Chart (SFC)	Sequential process
Function Block Diagram (FBD)	Process flow
Ladder Diagram (LD)	Electrical flow
Structured Text (ST)	Textual, calculative
Instruction List (IL)	Boolean, simple, textual
IEC 61499	Distributed process

For more information consult [isagraf.com](http://isagraf.com)

# Easergy HU250 Head Unit Communication

## Open Programmable Logic Controller

### Intelligent loop automation reconfiguration (self-healing network) <sup>(1)</sup>

#### Overhead and pad-mounted designs

An evolution of the classic loop automation algorithm to an intelligent loop automation utilizes peer-to-peer communications to exchange messages between feeder, mid-point and tie devices. This exchange reduces stress to pole-mounted switchgear by helping to eliminate unnecessary re-energization.

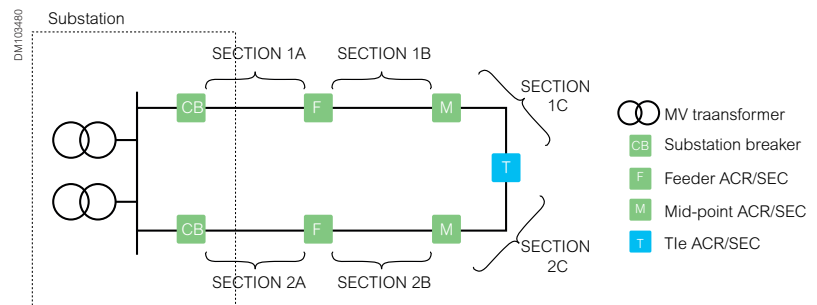

The loop automation applications consist of a number of ACR/SEC devices distributed in an open ring topology. Each device in a loop automation scheme operates independently according to its predefined role, each with its own set of operation rules.

### Bus tie coupling (BTA) <sup>(1)</sup>

The BTA (Bus Tie Automatism) is an automation system for switching sources between two incoming lines (SW1 and SW2) and a busbar coupling switch (SW3). It issues the voltage presence detectors of the SC150 and the MV fault current detection function on the busbar incoming lines.

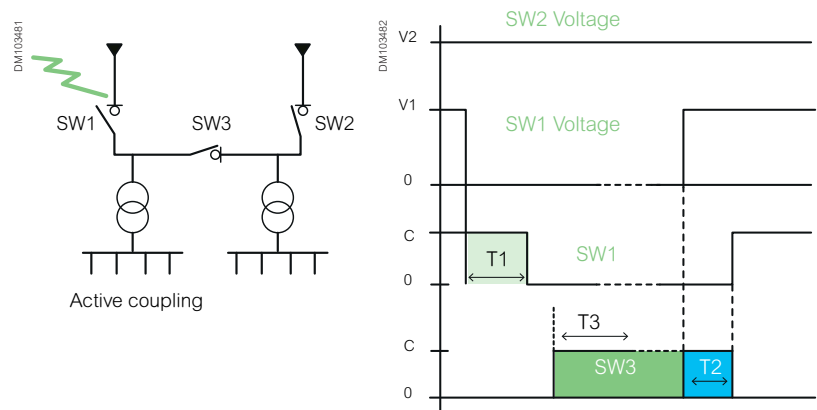

<sup>(1)</sup> Available on project, consult us



# Easergy HU250

## Head Unit Communication

### Communication port characteristics

Modems box and interface	Technical characteristics
Serial modem box	<ul style="list-style-type: none"> <li>• RJ45 connector The serial modem interface is configurable</li> <li>• RS232 <ul style="list-style-type: none"> <li>– with all control signals for external modems such as radio or PC connection</li> <li>– Maximum flow rate: 115200 bit/s</li> </ul> </li> <li>• RS422/RS485 <ul style="list-style-type: none"> <li>– Maximum distance: 1500 m</li> <li>– Maximum flow rate: 38400 bit/s</li> <li>– Adaptation and polarization resistor: configurable for 2 wires</li> <li>– 2 Wires or 4 wires: configurable by the HU250</li> </ul> </li> </ul>
3G and 4G modem box	<ul style="list-style-type: none"> <li>• 3G modem box <ul style="list-style-type: none"> <li>– Five Bands UMTS/HSPA+ (WCDMA/FDD) (850/800, 900, 1900 and 2100 MHz)</li> <li>– Quad-Band GSM (850/900/1800/1900 MHz)</li> </ul> </li> <li>• 4G modem Box EU standard version <ul style="list-style-type: none"> <li>– Penta Band LTE: 800/900/1800/2100/2600 MHz; FDD-Band (20, 8, 3, 7, 1)</li> <li>– Tri Band UMTS (WCDMA): 900/1800/2100 MHz; FDD-Band (8, 3, 1)</li> <li>– Dual Band GSM/GPRS/EDGE: 900/1800 MHz</li> <li>– GPS clock synchronisation option (required additional antenna)</li> </ul> </li> <li>• 4G modem Box US standard version <ul style="list-style-type: none"> <li>– Penta Band LTE: 700/700/850/AWS (1700/2100)/1900 MHz; FDD-Band (13, 17, 5, 4, 2)</li> <li>– Tri Band UMTS (WCDMA): 850/AWS (1700/2100)/1900 MHz; FDD-Band (5, 4, 2)</li> <li>– Quad Band GSM/GPRS/EDGE: 850/900/1800/1900 MHz</li> <li>– GPS clock synchronisation option (requires additional antenna)</li> </ul> </li> </ul>
Ethernet port (# 8)	<ul style="list-style-type: none"> <li>• 10/100 base T RJ45</li> <li>• Auto-negotiation</li> <li>• DHCP client</li> <li>• Insulation Port: 4 kVACrms/8 kV surge</li> </ul>
Ethernet port (# 9 and #10)	<ul style="list-style-type: none"> <li>• 10/100 base T RJ45 daisy chain</li> <li>• Auto-negotiation</li> <li>• DHCP server</li> <li>• Insulation 2 kVACrms/5 kV surge</li> </ul>
Serial port	<ul style="list-style-type: none"> <li>• RS485 connector</li> <li>• Insulation 2 kVACrms/5kV surge</li> </ul>
Wi-Fi	<ul style="list-style-type: none"> <li>• 2.4GHz band IEEE 802.11n. Backwards compatible with IEEE 802.11b/g</li> <li>• Security WPACOMP</li> <li>• DHCP server</li> </ul>
Mini USB	<ul style="list-style-type: none"> <li>• USB Device</li> </ul>
USB	<ul style="list-style-type: none"> <li>• USB connector type B</li> <li>• USB Host</li> </ul>

# Easergy HU250

## Head Unit Communication

### Characteristics

#### General characteristics

Dielectric compatibly			
Dielectric	IEC 60255-27	Common mode (CM):	<ul style="list-style-type: none"> <li>Insulation (50 Hz/1 min.): 2 kV</li> <li>Surge (1.2/50 µs): 5 Kv</li> </ul>
Electromagnetic compatibility / Immunity			
Electrostatic discharge	IEC 61000-4-2 Level 4/ Criteria B	15 kV in air 8 kV at contact	
Radiated RF electromagnetic fields	IEC 61000-4-3 Level 4/ Criteria A	30 V/m – 27 MHz to 6 GHz	
Fast transients	IEC 61000-4-4 Level 4/ Criteria A	Power supply, Ethernet	CM: ±4 kV 5 kHz – 100 kHz
		Other circuits	CM: ±2 kV 5 kHz – 100 kHz
Surge	IEC 61000-4-5 Power supply: Level 4/ Criteria A  Other circuits: Level 3/ Criteria A	<ul style="list-style-type: none"> <li>CM: 2 kV - wave 1,2/50 µs</li> <li>DM: 1 kV - wave 1,2/50 µs</li> </ul>	
Conducted RF disturbances	IEC 61000-4-6 Level 3/ Criteria A	10 Veff	
		0.15 MHz to 80 MHz	
Power frequency magnetic field	IEC 61000-4-8 Level 5/ Criteria B	<ul style="list-style-type: none"> <li>100 A/m – 50 Hz enduring</li> <li>1000 A/m from 1 to 3 s</li> </ul>	
Immunity to voltage dips	IEC 61000-4-29 Criteria A	Voltage dip:	<ul style="list-style-type: none"> <li>24 Vdc : 100 ms</li> <li>48 Vdc : 500 ms</li> </ul>
		Voltage interruption:	<ul style="list-style-type: none"> <li>24 Vdc : 100 ms</li> <li>48 Vdc : 500 ms</li> </ul>
Pulse magnetic field immunity	IEC 61000-4-9 Level 5/ Criteria A	1000 A/m	
Conducted common mode disturbance	IEC 61000-4-16 Level 4/ Criteria A	CM: 30 V for 15 Hz to 150 kHz 300 V during 1 s	
Damped oscillatory waves	IEC 61000-4-18 Level 3/ Criteria A	CM: 100 kHz, 1 MHz, 3 MHz, 10 MHz, 30 MHz - 2 kV	
Emission tests			
Radiated disturbances	CISPR22	Class A (EN5502)	

**Criteria A definition:** The unit shall continue to operate as intended during and after the test. No degradation of performance or loss of function is allowed below a performance level specified by the manufacturer, when the apparatus is used as intended. The performance level may be replaced by a permissible loss of performance.

**Criteria B definition:** The unit shall continue to operate as intended after the test. No degradation of performance or loss of function is allowed below a performance level specified by the manufacturer, when the apparatus is used as intended. The performance level may be replaced by a permissible loss of performance. During the test, degradation of performance is however allowed. No change of actual operating state or stored data is allowed.

# Easergy HU250

## Head Unit Communication

### Characteristics

#### General characteristics

Environmental conditions		
Operating temperature	IEC 60068-2-1	-40 °C to +70 °C
	IEC 60068-2-2	
Storage temperature	IEC 60068-2-1	-40° C to +85 °C
	IEC 60068-2-2	
Damp heat, steady state	IEC 60068-2-78	93% RH, 40 °C, RH no condensation, 56 days
Change of temperature	IEC 60068-2-14	-40 °C to +70° C, 5 °C/min, 10 Cycles, 27 h without condensation
Damp heat, cyclic	IEC 60068-2-30	144 h: 6 cycles of 24h (+55 °C, 93% HR during 9 h; +25 °C, 95% HR during 6 h)
Salt spray test	IEC 60068-2-11	168 h
Product safety standards		
Protection of persons and goods.	IEC 60255-27	
Fire resistance	IEC 60695-2-11	850 °C
Power supply		
Rated supply voltage		12...48 Vdc (+/-20 %)
Power consumption		3 VA

#### Mechanical characteristics

Degree of protection	IEC 60529	<ul style="list-style-type: none"> <li>• Front panel: IP4x</li> <li>• Module body: IP2x</li> </ul>
Robustness	IEC 62262	IK7 2 J
Vibrations	IEC 60068-2-6	10 to 2000 Hz / 1 g (peak value) 10 cycles
Bumps	IEC 60068-2-29	10 g / 16 ms / 1000 Bumps non energized
Shocks	IEC 60068-2-27	10 Gn / 11 ms / 3 pulses in operation
Weight		0.55 kg
Dimensions (H x W x D)		140 mm x 90 mm x 140 mm

# Easergy HU250 Head Unit Communication Configuration tools

EM100101

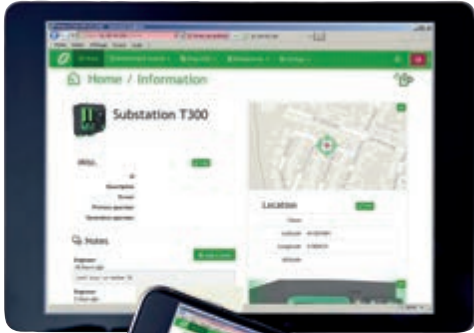

Home



EM100102

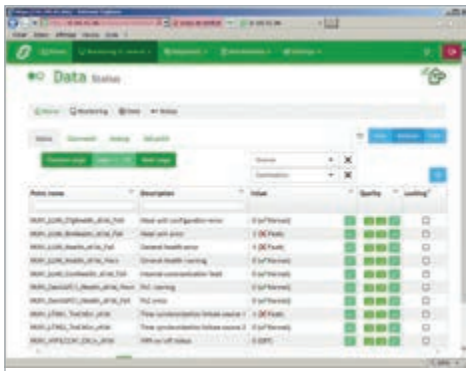

Monitoring / Data / Status

EM100103

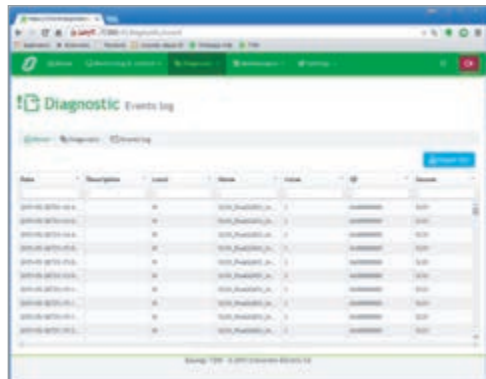

Diagnostic / Events

## T300 Web Server - Commissioning, operation and maintenance

HU250 includes an embedded Web Server as HMI interface and local supervision of the substation for the user.

Basic configuration, operation and diagnosis are carried out by connecting a laptop, tablet or smartphone to the T300 Web Server. This web server can be accessed:

- Locally via ETH port  
(laptop directly connected to one of the T300 Ethernet ports)
- Locally via Wi-Fi access
- Remotely via LAN network
- Remotely via 2G, 3G, Ethernet
- The menu on the home page enables the user to select the language
- The web data server's HTML format pages includes different pages and subpages:
  - Home page: local map, GPS coordinates, photos and notes to identify the substation
  - Monitoring and control page: physical view of the system, data view including display of status and analogs, control of commands and set points
  - Diagnostic page: to consult and export.csv file (events log, cyber security log and system log)
  - Maintenance page: user settings, clock synchronization, IP configuration settings, device status, software version update, configuration download
  - Settings page: setting per module (HU250, SC150, etc.). These settings per module include the configuration of functional parameters for communication, protocol, switch control, measurement and detection, etc.

### Operation and control

Alongside operation and control of the network from the SCADA system, it is possible to operate the equipment locally or remotely using data pages:

- Displaying status and measurement
- Issuing commands: switches, automation system on/off, MV fault detector reset and other digital outputs, which is made more secure by a selection and confirmation process
- Consultation of archived data
  - On-screen consultation of archive logs
  - Extraction of logs on a PC as a .csv file for analysis

# Easergy HU250 Head Unit Communication Configuration tools

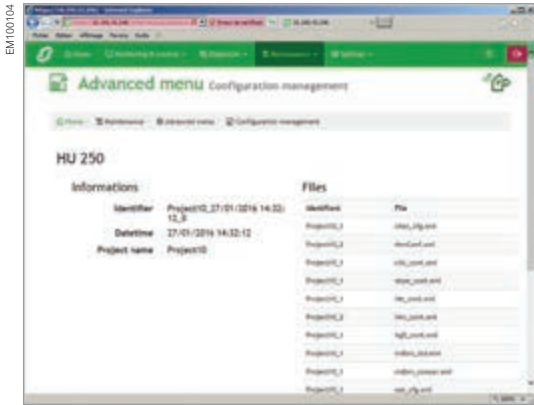

T300 Web Server: Maintenance / Configuration

## Maintenance

- The Web Server is used to manage the T300 configuration based on files stored locally in the HU250 memory or saved externally on a backup device. Three configuration files can be stored in T300, for example :
  - the active configuration
  - the Backup configuration (factory configuration for example)
  - the future configuration
- System events log file analysis
- Transmission of maintenance events

## Setting by web server

- **Configuration**  
The settings that can be changed on the web server:
  - Switch management: command type and delays
  - Measurement sensors, fault current detectors, voltage presence parameters
  - Automation systems: operation mode and delays
  - Communication: protocol parameters, port operating mode
- **Configuration by downloading files**
  - Loading the predefined configuration with Easergy Builder
  - Saving one or two configurations for restoration

## DNS server

HU250 includes a Wi-Fi DNS server. The access to the web server can be made simply by entering the T300 default address in the browser: <https://T300>.

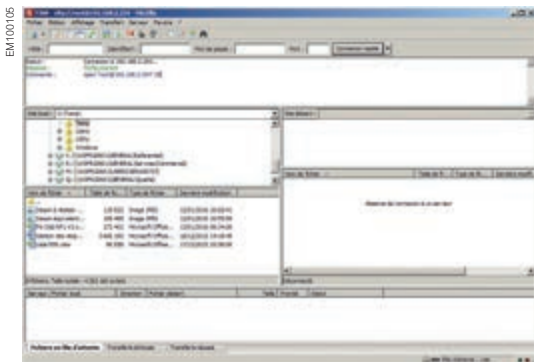

FTP server - Filezilla

## Firmware upgrade

HU250 firmware can be easily upgraded locally or remotely using a free FTP server for example (e.g., Filezilla).

The firmware is sent to the unit by processing a file transfer to a specific folder of the HU250 tree.

The transfer via FTP server can be made locally via an Ethernet port on the unit or remotely via Wi-Fi or LAN access.

If an issue occurs during installation of the firmware, or if the firmware installed is found to be corrupt, the system aborts the update and automatically reactive the previous firmware version.

# Easergy HU250 Head Unit Communication Configuration tools

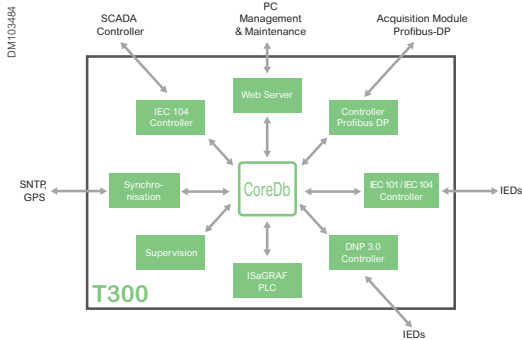

Easergy Builder: Relationship between coreDb and other applications

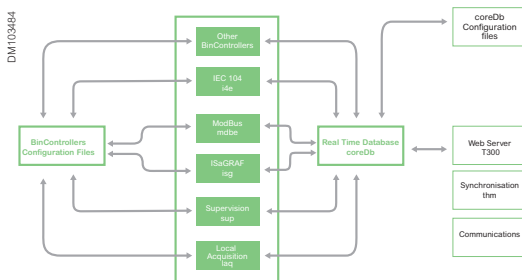

Easergy Builder: Real-time operating system architecture

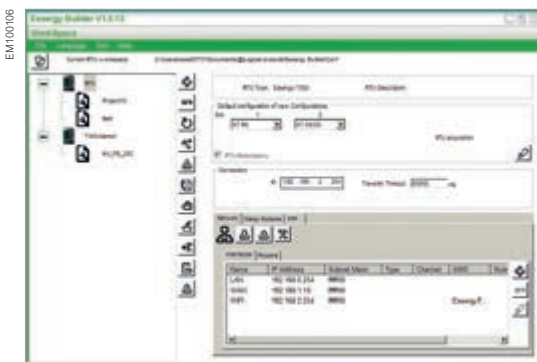

WorkSpace: RTU setting



WorkSpace: Device architecture page

## Easergy Builder

Easergy Builder is the advanced configuration tool of the T300 RTU, reserved for the expert support team.

The basic use of T300 does not require advanced modifications of the T300 configuration.

The web server is sufficient for the user to personalize the system and change basic settings.

### Interface

Easergy Builder permits the modification of an existing T300 configuration from the main page WorkSpace.

This page includes the following general settings:

- IP parameters for LAN, WAN, Wi-Fi access (IP address, delays, etc.)
- Slot (K7) to be used for the communication (RS232/485 or 3G)

The WorkSpace can manage several T300 RTU configurations. The WorkSpace page displays as a diagram the architecture of each T300 application (architecture of the different devices included in the configuration).

Each of the following elements (named devices) can be associated with a T300 RTU application:

- Master/Slave protocol setting (IEC 104, DNP3)
- ISaGRAF® project interface
- Supervision setting
- Local acquisition setting (input/output)
- SOE setting (Sequence Of Events)
- CoreDb signals (real-time database), including status, command, analog, setpoint
- Synchronization setting

To personalize the RTU application, Easergy Builder uses four main groups of settings pages:

- Devices: one device for each function (protocol, modem port, SOE, ISaGRAF, input/output)
- Channels: one channel for each internal or external communication link
- CoreDb: database including variables, labels and mapping of the application
- Synchronization: setting to synchronize the unit by SNTP server or by the protocol

# Easergy HU250

## Head Unit Communication

### Configuration tools

---

#### Calculation formula

The calculation formulas are used to carry out math, combinational logic operations or others on T300 data in order to perform specific personalized functions. These Calculation formulas can be created via Easergy Builder. The list of operations available are given in the Easergy Builder User Manual. Refer to this document for more information related to the calculation formulae.

#### IEC 61131-3 PLC

An IEC 61131-3 programming tool (IsaGRAF® platform) is available with the T300 for developing PLC programs.

This IsaGRAF® platform is an external software tool to be installed on a PC. It is used to develop specific custom applications in the following programming languages:

- **SFC**: Sequential Function Chart
- **FBD**: Function Block Diagram
- **LD**: Ladder Diagram
- **ST**: Structured Text
- **IL**: Instruction List

## Management of RBAC and security policy

The T300 is provided with a standard security policy and a default RBAC (roles assigned to a number of predefined users).

The T300 security policy is managed by a special tool - SAT (Security Administration Tool).

The SAT can be used during the engineering phase to redefine or change the system access restrictions, including the access rights and responsibilities, via an RBAC (Role-Based Access Control) model.

Once the security policy is established in the SAT, the commissioning phase done in the Web server will be only limited to adding or deleting users, to modify their associated passwords, and to assign or modify one or more of the roles predefined in the SAT to these users.

See the **Managing Users and Roles** section for more information on how to set these parameters.

Instructions on how to configure the security policy in the SAT are given in the **SAT User Manual**. Refer to this document for more information.

# Easergy SC150

## Switch Controller Unit



# Easergy SC150

## Switch Controller Unit

### General description

#### All advanced functions for MV line and switchgear management in a compact box

- Switchgear control and monitor
- Advanced fault detection
- Power measurement
- Power quality
- Sectionalizer automation
- Embedded operator HMI



The SC150 supports the following functions related to one MV cubicle:

- MV switchgear control and monitor
- MV current and voltage measurement
- Fault passage detection and indication
- Local automation
- Power measurement and power quality

### MV switchgear control and monitor

The SC150 is compatible with any form of MV switchgear:

- Single or dual control-command to the switch
- Control security by dual relays: select and execute
- Local and remote control with remote or local operating mode
- Motor mechanism voltage control: 12 Vdc to 220 Vdc and 120 Vac to 220 Vac
- Dummy control simulation available remotely or locally

### MV current and voltage measurement

- SC150 is compatible with standard current sensors according to IEC 60044-1
- Three mountings are possible for acquiring current measurement:
  - 3 phase CTs
  - 1 core balance CT
  - 3 phase CTs + 1 core balance CT

#### SC150 Part Number

Reference	Description
EMS59201	SC150-CT-VT/LPVT current transformer interface – VTs and LPVT voltage interface
EMS59202	SC150-CT- CAPA current transformer interface – capacitor voltage interface (VPIS, VDS, PPACS)

#### Voltage measurement or indication using from different types of sensors:

- LPVT (Low Power VTs) according to IEC 60044-7
- Standard MV/LV VTs with secondary from 57 Vac to 220 Vac according to IEC 60044-2
- Schneider VPIS (switchgear voltage indicator) with voltage output
- VDS voltage indicator with voltage output according to IEC 61243-5
- External divider capacitor mounted on the MV cable head

# Easergy SC150 Switch Controller Unit

## General description

---

### Fault Passage Indicator (FPI)

The fault current detections are compatible with all existing ground neutral systems with or without presence of distributed generation. The fault detection is based on international standards of ANSI codes:

- Phase overcurrent fault detection (ANSI 50/51)
- Ground (earth) fault detection (ANSI 50N/51N)
- Negative sequence overvoltage/broken conductor detection (ANSI 47)
- Directional phase overcurrent fault detection (ANSI 67)
- Directional ground (earth) fault detection (ANSI 67N)

Three ammetric fault detection instances and two directional fault detection instances, each with their specific settings and detection mode, can operate separately or simultaneously on the MV fault detector and for each SC150 channel. The first instance that checks the fault condition activates the detector and the corresponding indicator on the T300.

The ability to combine instances allows the T300 to adapt to the characteristics and type of protection used upstream in line with the MV network characteristics. This also enables adjustment based on the fault current values measured by the measurement sensors.

For example, one instance can be defined for overload detection (typically an IDMT curve) and another instance can be defined for short-circuit detection (typically a DT curve).

Each instance includes 2 groups of settings. These 2 groups correspond to 2 sets of thresholds and time delays that are typically linked to 2 upstream protection settings.

### MV Power measurements and power quality

Advanced power measurement and power quality are available on each SC150 in accordance with EN50160 directive:

- Power measurements according to the principles of IEC 61557-12
- Voltage power quality according to the principles of IEC 61000-4-30 class S

### Automation systems

The automation systems concerning several switchgear and MV network systems such as Automatic Transfer Source (ATS), self healing, etc., are hosted in HU250 and are designed in a IEC 61131-3 PLC workbench.

The sectionalizer automation (SEC) concerning one switchgear is managed by the SC150 module. This automation is factory predefined but configurable on site (setting).

Sectionalizer (SEC): Automatic control for opening the MV switch following detection of a number of fault currents in the source substation reset cycle.

# Easergy SC150

## Switch Controller Unit

General description

### Local operator front panel (HMI)

#### Display of information by coloured LEDs

- Module status
- Alarm status
- Local/remote status (information provided by the HU250 module)
- Automation status: ON/OFF and lock status

#### 3 customisable LEDs

#### Switch status

- Main switch position (open, closed, intermediate)
- Ground switch position

#### Fault detection and voltage indications

- Fault detection status with direction
- Voltage presence status

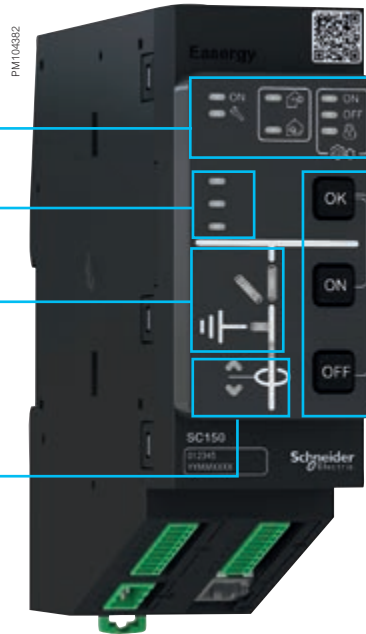

#### Local operator switch control

The local switch control is allowed when the operating mode on the HU250 is set to local:

- In Local mode: the command from the operator cabinet is confirmed, any order from the remote control center is locked
- In Remote mode: local commands are not permitted, orders from the remote control center are validated
- Switch control: the operator must press the OFF or ON buttons and the OK button.
- The local control can be enabled/disabled by configuration

#### Automation system activation

The automation system is activated and deactivated globally by pressing the control and validation buttons at the same time on the HU250.

#### Daisy chain LAN

- Internal Ethernet LAN for Easergy T300 modules
- Ethernet 10/100 Base

#### Switchgear status

- 8 singles or duals Wet input (0 V Common)
- compliant to IEC 61131 -2

#### Switchgear control

2 digital outputs configurable

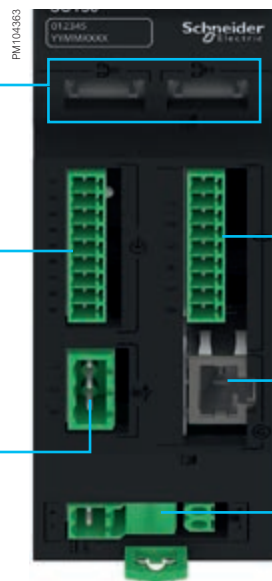

#### Current acquisition

4 current inputs with standard CT

#### Voltage acquisition

3 phase acquisition through RJ45 interface and accessory sensors

#### Daisy chain power supply

12-48 Vdc

# Easergy SC150 Switch Controller Unit

## General description

### Management of different types of switches

- A library of ready-to-use switchgear control is provided and corresponds to all motor mechanism controls:
  - Single point control
  - Double point control
  - Simple mechanical motor (tumbler type)
  - One-latch operating mechanism
  - Two-latch operating mechanism
- The required control settings are configurable

### Switchgear operation

- To help the reliability of the operation, the switch command is executed via two serial relays: selection and execution. If only one relay is activated or if the “select relay” does not return to normal position, the switch command is not performed or locked and an alarm is generated
- Dummy control function allows simulating switch command actions on the SC module, locally or remotely via the web pages
- In addition, the voltage motor output on the PS50 power supply can be activated only when one command is processing

### General functional characteristics

Technical	
Clock synchronization	Clock synchronization from HU250 IEEE1588
Time-stamped resolution	SNTP: 10 ms IEEE 1588: Configurable 1 ms; 5 ms; 10 ms

### Switchgear control functions

Logical nodes	Data Object	Description
XSWI	MainXSWI	MV switchgear position status
CSWI	MainCSWI	Switchgear control function
SSWI	MainSSWI	Switchgear supervision
PhXSWI	OpCnt	Number of operations
SCSWI	SimCSWI	Dummy control simulated position control
XSWI	SimXSWI	Dummy control simulated position status
XSWI	EarthXSWI	Ground switch position status
CILO	MainCILO	Switchgear Interlocking
GGIO	FeaGGIO	Other inputs
GAPC	SecGAPC	Sectionalizer (SEC) automatic control

# Easergy SC150

## Switch Controller Unit

### Switchgear control

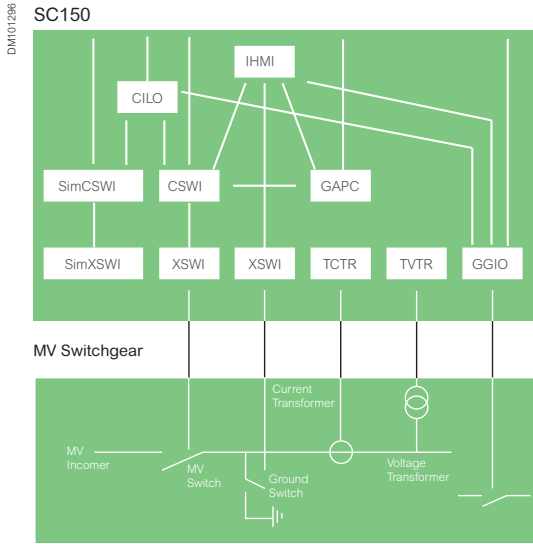

#### Switchgear control settings

MainCSWI	Type of control point	Pulsing SPC or DPC Latched SPC or DPC SBO (select before operate) SPC or DPC if supported by SCADA protocol
	Pulse operating time	50 ms to 20 s in 10 ms step
	Return position time (operation time out)	1 s to 30 s in 100 ms step
MainXSWI	Type of status point	Single point status SPS Double point status DPS
	Double-bit intermediate state filtering time delay	1 s to 30 s in 100 ms step
EarthXSWI	Type of status point	Single point status SPS Double point status DPS
FeaGGIO	Type of status point	Single point status SPS
	Change memory time	0: disable 5 ms to 2 s in 1 ms step
General GGIO setting (SPS and DPS)	Debouncing time	0: disable 5 ms to 30 ms in 1 ms step
	Chatter filtering	Monitoring period: 0: disable - 5 ms to 1 min in 1 ms step Maximum number of changes: 1 to 255 in 1 change step
MainCILO		Digital input 5 dedicated for interlocking : activate /deactivate

# Easergy SC150

## Switch Controller Unit

### Switchgear control

#### Characteristics

Outputs	
Rated motor mechanism voltage	12 Vdc to 127 Vdc / 90 Vac to 220 Vac
Rated voltage	250 Vac
Max switching voltage	440 Vac
Rated current	8 A
Limiting continuous current	8 A
Limiting making current, max 4s	15 A
Breaking capacity max	2000 VA
Typical motor control current	16 A for 50 ms and 6 A for 15 s

Input	
8 single or dual wet inputs (0V common) compliant to IEC 61131 -2	

Standard wiring	
2 SPS or 1 DPS	Switch opened Switch closed
1 DPS or 2 SPS or 1SPS	Ground switch closed Ground switch open
1 SPS	Switch interlocking
1 SPS	Voltage presence
2 SPS	Free

#### Connection example

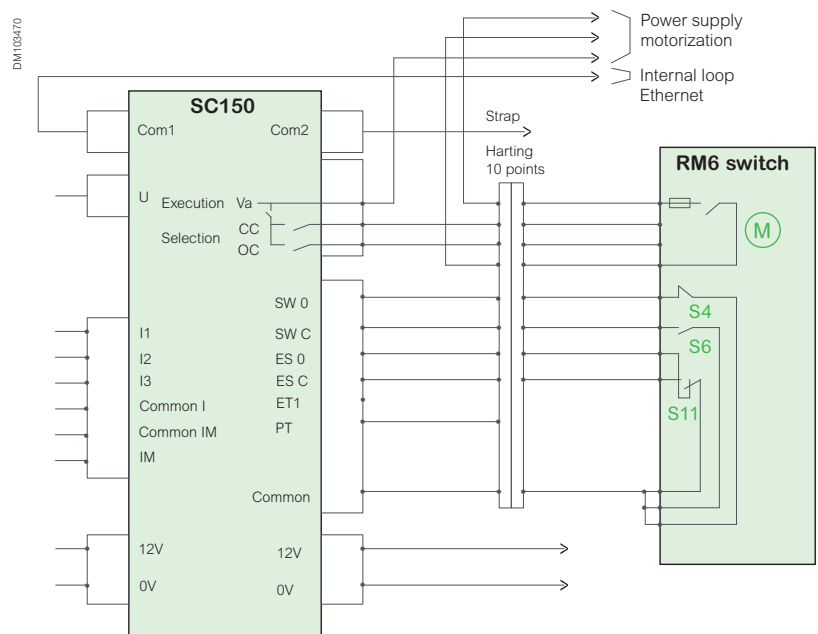

MV switch mechanics control wiring

# Easergy SC150 Switch Controller Unit

## Voltage measurement

The SC150 offers many capabilities and quality levels to measure and monitor MV voltage. The voltage metering accuracy depends mainly on the kind of MV voltage sensors. According to the selection table, the SC150 allows the measurement of MV voltage for:

- MV Fault passage indication
- Automation and monitoring
- Voltage measurement
- Power measurement
- Power quality

Logical node name:

**TVTRx**

x being the number of the instance

## MV Voltage acquisition

Easergy SC150 can be connected to one or several types of MV voltage sensor mounted in the Medium Voltage cubicle.

MV voltage sensors or interface	Description
VPIS-VO (V3)	Schneider Electric Voltage Presence Indicator System with voltage output according to IEC 62271-206. The VPIS-VO (V3) is connected to capacitor divider mounted in MV cubicle
VDS	Type LRP, LRM and LR Voltage Detector System with voltage output according to IEC 61243-5 The VDS is connected to capacitor divider mounted in MV cubicle
PPACS	External capacitor divider connected to the MV cable head
VTs	Standard VTs according to IEC 60044-2 with external Easergy SC150 - VT - adapter
LPVT	Low Power VTs according to IEC 60044-7

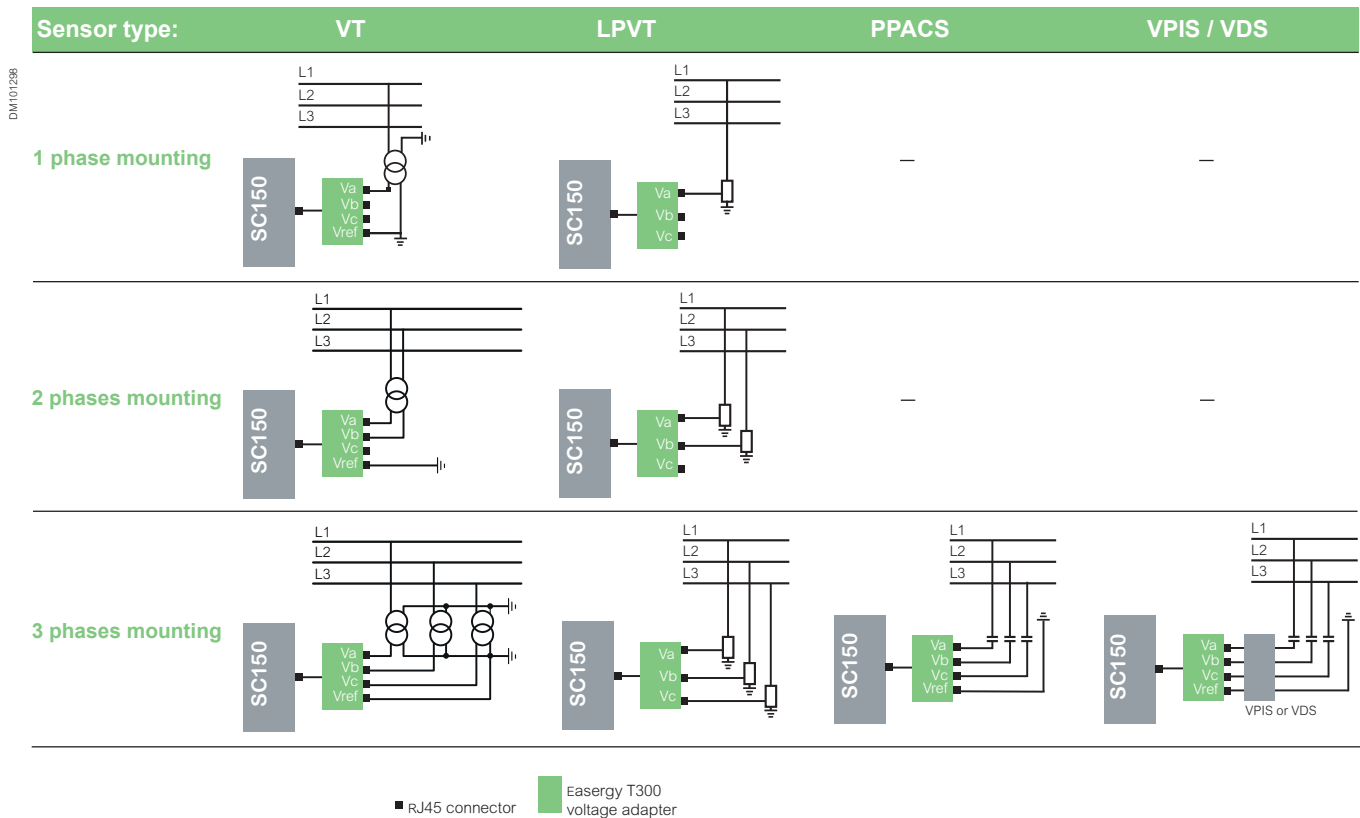

# Easergy SC150 Switch Controller Unit

## Voltage measurement

### Voltage configuration selection guide

Functions	No voltage	Single phase VT or LPVT	3 phase VT or LPVT	VPIS V3 VDS PPACS
<b>FPI</b>				
ANSI 50/51	•	•	•	•
ANSI 50N/51N	•	•	•	•
ANSI 67			•	•
ANSI 67N			•	•
ANSI 47			•	•
ANSI 27		•	•	•
ANSI 59		•	•	•
ANSI 59N			•	•
<b>Measurement</b>				
Voltage measurement 3 phases			•	•
Voltage measurement single phase		•		
Residual voltage			•	•
Power measurement		•	•	
Power quality			•	
<b>Automation</b>				
Sectionalizer		•	•	•
Automatic Transfert of Source <sup>(*)</sup>		•	•	•

<sup>(\*)</sup> Consult us for availability



# Easergy SC150 Switch Controller Unit

## Voltage measurement

### Voltage measurement settings and characteristics

Voltage input setting		
Type of sensor input	VPIS VO; VDS; PPACS; LPVT; VT; Sample value from other SC150	
Voltage input wiring	Single phase; 3 phases	
Un network rated voltage	3 kV to 36 kV in 1 V step	
Capacitor rated value VPIS, VDS and PPACs	Automatic calibration	
LPVT	Rated value	Configurable from 0 V to 10 V in 0.001 V step
	Magnitude correction	<ul style="list-style-type: none"> <li>0.5 to 2.0 in 0.00001 step</li> <li>Phase angle: -180° to +180°</li> </ul>
VT	Secondary rated value	Configurable from 50 V to 250 V in 0.001 V step
	Magnitude correction	30 to 60 in 0.001 step
PhRot	<ul style="list-style-type: none"> <li>1 = ABC</li> <li>2 = ACB</li> </ul>	

Voltage measurement characteristics		
Metering range	0.1 Un to 2 Un	
Accuracy without sensor	Standard	IEC 61557-12
	Voltage	<ul style="list-style-type: none"> <li>0.5% - from 20% Un to 120% Un</li> <li>5% - Un &lt; 20% and Un &gt; 120%</li> </ul>
Voltage accuracy with sensors	LPVT	0.5% with calibration
MV voltage range	Rated voltage (Un)	up to 36 kV
	Frequency	45 to 67 Hz
Voltage Input Impedance	<ul style="list-style-type: none"> <li>SC150 capacitor interface: 4 MΩ</li> <li>SC150 LPVT-VT interface: 10 MΩ</li> </ul>	

### Voltage acquisition adapter

The different MV sensors used with the SC150 are summarized in Accessories Chapter.

Each type of voltage sensor requires a specific adapter (available as an option) for connection to the SC150 module.

# Easergy SC150 Switch Controller Unit

## Current measurement

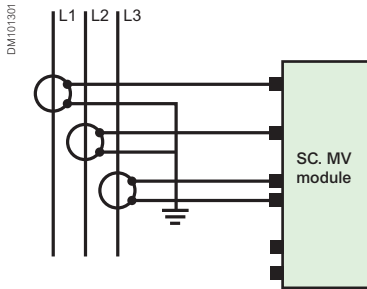

Mounting A: 3 phase CTs

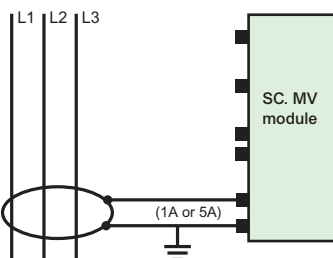

Mounting C: 1 core balance CT

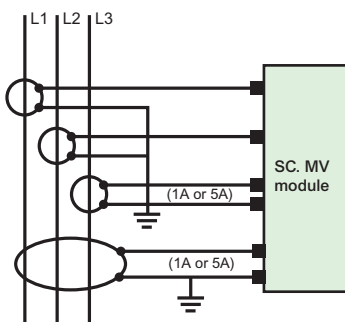

Mounting D: 3 phase CTs  
+ 1 core balance CT

Logical node name:

**TCTR<sub>x</sub>**

x being the number of the instance

## Description

The Easergy SC150 module offers many high-performance features needed to measure and detect a fault current on the MV line.

Three CT mountings are possible depending on the required measurement capabilities, the neutral system of the MV network, the ground fault detection capability required and the MV cables used.

## MV Current acquisition

- Type A: 3 phase current transformers
- Type C: 1 core balance current transformer
- Type D: 3 phase current transformers and 1 core balance current transformer

## Applications and selector guide

Functions	Mounting		
	Type A	Type C	Type D
<b>MV cable type</b>			
Unipolar cables	•	•	•
Tripolar cables		•	
<b>FPI</b>			
ANSI 50/51	•		•
ANSI 50N/51N	•	•	•
ANSI 67	•		•
ANSI 67N	•	•	•
Sensitive ground fault detection (50N/51N and 67N)			•
<b>Measurement</b>			
Phase current RMS	•		•
Residual current RMS		•	•
Residual current computed	•		•
True power measurement	•		•
<b>Automation</b>			
Sectionalizer	•	•	•
Automatic Transfer of Source (*)	•	•	•

(\*) Consult us for availability

# Easergy SC150

## Switch Controller Unit

### Current measurement

#### Current transformer settings and characteristics

Settings		
Type of CT mounting		<ul style="list-style-type: none"> <li>Type A I1, I2, I3</li> <li>Type C: IO</li> <li>Type D: I1, I2, I3, IO</li> </ul>
Primary phase CT rated (In)		Adjustable from: 50 A to 1250 A in 1 A step
Secondary phase CT rated (Ins)		1 A / 5 A
Primary core balanced CT rated (Ino)		Adjustable from: 50 to 1250 A in 1A step
Secondary core balanced CT rated (Inos)		1 A / 5 A
CT connection		<ul style="list-style-type: none"> <li>Normal</li> <li>Inverted</li> </ul>
Characteristics		
Measurement range	Phase CT input	0.01 In to 7 In
	Core balanced CT input	0.01 In to 3.5 In
Accuracy	Standard	IEC 61557-12
	Current	0.5 % : from 0.1 In to 1.2 In
Permissible overload		<ul style="list-style-type: none"> <li>10 A In continuous</li> <li>50 A In-10 s per hour</li> <li>120 A -1 s</li> </ul>
Impedance		1miliOhm
Burden		0.025 VA

# Easergy SC150 Switch Controller Unit

## Fault current detection

Advanced Fault Passage Indicator based on IEC 61850 data model and ANSI code

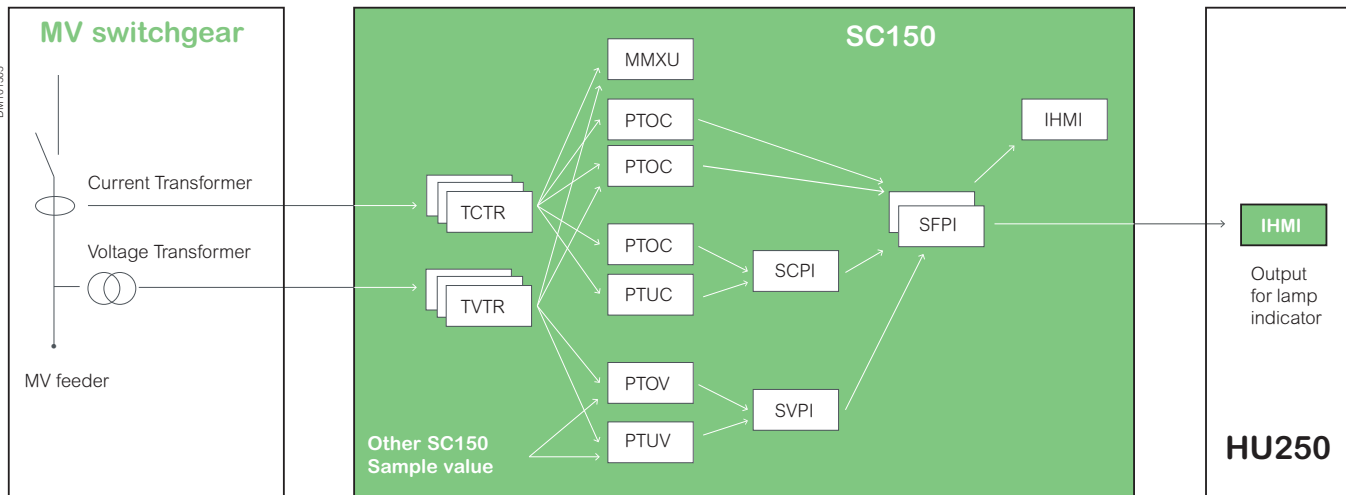

Logical node name:  
**SFPI**

### All types of fault currents are tracked

The SC150 offers a complete range of Fault Passage Indicators (FPI) needed to detect a fault current in any kind of neutral system with or without the presence of distributed energy resources on the MV or LV network

The FPI aim is to provide persistent indication of the presence or absence of a fault current and also track all non-permanent faults current in order to facilitate network maintenance and improve the quality of services.

The FPI function includes counters to memorize the type and the number of fault current, to be able to make diagnostics or statistics about the quality of the network.

The following FPI events can be activated and memorized:

- Permanent fault current: fault current confirmed by SVPI or SCPI
- Semi-permanent fault current: eliminated by the slow cycles of recloser (cycle 2 or cycle 3)
- Transient fault current: eliminated by the fast cycle (cycle 1)

### Fault detection confirmation

In order to detect a persistent or non permanent fault current on the network, a fault detection can be configured:

- Unconfirmed
- Confirmed by voltage dip from power supply
- Confirmed by voltage absence
- Confirmed by current absence

# Easergy SC150 Switch Controller Unit

## Fault current detection

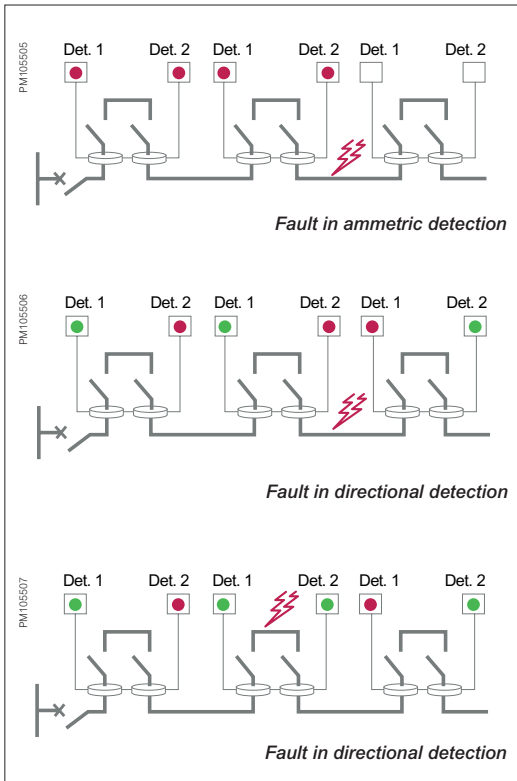

Examples of colors indicating a fault

### Inrush filter

A filter for detecting transformer inrush current can be enabled on the T300 to help prevent spurious fault currents being detected on the MV network.

A current peak may occur on power-up of the MV network due to energization of the transformers and saturation of the phase CTs installed on the network. These current peaks may activate the fault current detectors falsely by tripping the configured thresholds.

To avoid this phenomenon, an algorithm is used to discriminate fault currents from transformer inrush currents on network power-up.

The algorithm for detecting the transformer inrush phenomenon is based on an analysis of the ratio between the second harmonic distortion and the fundamental current on the 3 network phase currents. The inrush filter becomes active when a high proportion of second harmonics are detected.

The inrush filter is only possible for ANSI 50/51, ANSI 50N/51N, and ANSI 67 type detection, and for instances 1 and 2 only.

### The fault detection is indicated:

- By two LEDs on each SC150 module
- By a flashing light outside the station
- Remotely to the SCADA system via the communication protocol

### FPI reset

All types of fault current are memorized by the system during the outage in order to be able to locate the fault current on the network when it is not energized.

Memorized fault current can be cleared:

- By a timer delay, configurable
- By manual action on the front cabinet of HU250 (general reset for all modules)
- By remote control from the SCADA
- By return of voltage presence (configurable)

### MV Fault Detector Logical Nodes

The T300 fault detection algorithms are based on the ANSI standards as well as on a certain number of logical nodes (LN, as described in standard IEC 61850) each with their own specific role. These are given for information purposes in the table below.

LN Type Name	LN class	Description
PhPTOC	PTOC	Phase over-current detection (ANSI 50/51)
EfPTOC	PTOC	Ground fault over-current detection (ANSI 50N/51N)
BcPTOV	POTV	Broken conductor detection (ANSI 47)
DirPhPTOC	PTOC	Directional phase over-current detection (ANSI 67)
DirEfPTOC	PTOC	Directional ground fault over-current detection (ANSI 67N)
AbsPTUC	PTUC	Current absence detection
PrsPTOC	PTOC	Current presence
AbsPTUV	PTUV	MV feeder voltage absence.
PrsPTOV	PTOV	MV feeder voltage presence
SVPI	SVPI	Voltage presence indicator based on inputs from PTOV, PTUV
SCPI	SCPI	Current presence indicator based on inputs from PTOC, PTUC
SFPI	SFPI	Computation of MV fault passage indication based on fault detection on confirmation (SVPI and/or SCPI)

# Easergy SC150 Switch Controller Unit

## Fault current detection

### Description

This over-current fault detection is based on the fundamental component of the 3 phase current rms (CT mounting type A and D).

### Setting groups

2 setting groups are available.  
Each instance has its own settings in each setting group.

A control allows you to change from one setting group to another during operation.

Logical node name:

**PhPTOCx**

x being the number of the instance

### Example of over-current detection

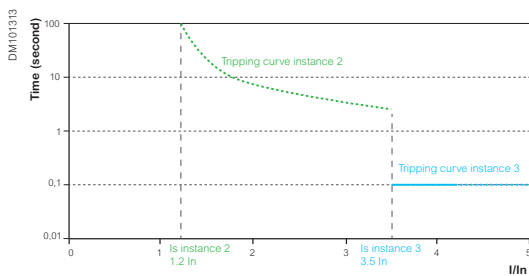

3 instances (fault detection) can run simultaneously with different settings:

- Instance 1: Disabled
- Instance 2: Enabled / IEC standard inverse /A
- Instance 3: Enabled / Definite Time (DT) curve

## ANSI 50/51: Phase over-current fault detection

### ANSI 50/51 : Over-current characteristics - LN: PHPTOC

Number of instances	3
Setting groups	2
Fault indication	<ul style="list-style-type: none"> <li>• General fault current</li> <li>• Phase on fault current: instance 1, 2 or 3</li> </ul>

### Setting (per instance)

Instance activity	<ul style="list-style-type: none"> <li>• Instance 1: disabled or enabled</li> <li>• Instance 2: disabled or enabled</li> <li>• Instance 3: disabled or enabled</li> </ul>				
Detection mode	<ul style="list-style-type: none"> <li>• Definite Time: All instance</li> <li>• Indefinite Time (IDMT): Instance 1 and 2 <ul style="list-style-type: none"> <li>- IEC standard inverse / A</li> <li>- IEC long time inverse / B</li> <li>- IEC very inverse / B</li> <li>- IEC extremely inverse / C</li> <li>- IEEE moderately inverse</li> <li>- IEEE very inverse</li> <li>- IEEE extremely inverse</li> </ul> </li> </ul>				
Over-current threshold	<table border="1"> <tr> <td>DT</td> <td>From 0.02 I<sub>N</sub> to 4 I<sub>N</sub> in 1 A step</td> </tr> <tr> <td>IDMT</td> <td>From 0.02 I<sub>N</sub> to I<sub>N</sub> in 1 A step</td> </tr> </table>	DT	From 0.02 I <sub>N</sub> to 4 I <sub>N</sub> in 1 A step	IDMT	From 0.02 I <sub>N</sub> to I <sub>N</sub> in 1 A step
DT	From 0.02 I <sub>N</sub> to 4 I <sub>N</sub> in 1 A step				
IDMT	From 0.02 I <sub>N</sub> to I <sub>N</sub> in 1 A step				
Time threshold	<table border="1"> <tr> <td>DT</td> <td>0 (Instance 3 only) / 0.05 - 300 s</td> </tr> <tr> <td>IDMT</td> <td>0.1 s to 12.5 s in 1 ms step</td> </tr> </table>	DT	0 (Instance 3 only) / 0.05 - 300 s	IDMT	0.1 s to 12.5 s in 1 ms step
DT	0 (Instance 3 only) / 0.05 - 300 s				
IDMT	0.1 s to 12.5 s in 1 ms step				
Reset time	DT 0 s - 0.05 - 300 s in 1 ms step				
Inrush filter (Instance 1 and 2)	Disabled / Enabled				

# Easergy SC150 Switch Controller Unit

## Fault current detection

### Description:

Ground fault detection is based on residual current values measured by a core balanced current transformer (type C and D) or calculated from 3 phase current transformers (type A and D).

With the mounting type D, we can accommodate two ground fault detections:

- Calculated residual current from 3 phase current transformer
- Measured residual current from core balanced sensors for high sensitivity

### Logical node name:

**EfPTOCx**

x being the number of the instance

### Example of ground detection

3 instances (fault detection) can run simultaneously with different settings:

- Instance n°1: Disabled
- Instance n°2: Enabled / IEC standard inverse /A
- Instance n°3: Enabled / Definite Time (DT) curve

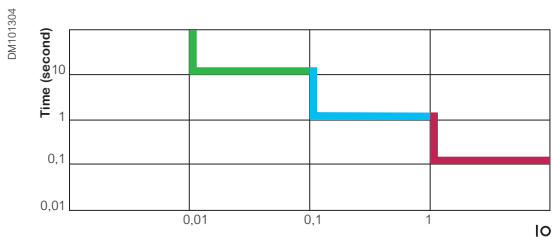

## ANSI 50N/51N: Ground over-current fault detection

### ANSI 50N/51N : Ground over-current characteristics

Number of instances	3 instances can run simultaneously with different settings
---------------------	--

Setting groups	2 groups
----------------	----------

Fault current indication	<ul style="list-style-type: none"> <li>• Fault detected</li> <li>• Cross country: Instance 3</li> </ul>
--------------------------	---

### Setting

Instance activity	<ul style="list-style-type: none"> <li>• Instance 1: Disabled or enabled</li> <li>• Instance 2: Disabled or enabled</li> <li>• Instance 3: Disabled or enabled</li> </ul>
-------------------	---

Residual current acquisition	<ul style="list-style-type: none"> <li>• <math>I_{res}</math> (by summation of the three phases)</li> <li>• <math>I_0</math> (directly from the core balanced CT)</li> </ul>
------------------------------	--

Detection mode	<ul style="list-style-type: none"> <li>• Definite Time: all instance</li> <li>• Indefinite Time (IDMT): Instance 1 and 2 <ul style="list-style-type: none"> <li>– IEC standard inverse / A</li> <li>– IEC long time inverse / B</li> <li>– IEC very inverse / B</li> <li>– IEC extremely inverse</li> <li>– IEEE moderately inverse</li> <li>– IEEE very inverse</li> <li>– IEEE extremely inverse</li> </ul> </li> </ul>
----------------	---

Over-current threshold	DT	• $I_{res}$ and $I_0$ : from $0.008 I_N$ to $1.6 I_N$ in 1 A steps
------------------------	----	--

IDMT	• $I_{res}$ and $I_0$ : from $0.008 I_N$ to $I_N$ in 1 A steps
------	--

Time threshold	DT	0 (Instance 3 only) / 0.05 - 300 s
----------------	----	------------------------------------

IDMT	0.1 s to 12.5 s in 1 ms steps
------	-------------------------------

Reset time	0s to 300 s in 1 ms steps
------------	---------------------------

Inrush filter (Instance 1 and 2)	Disabled / Enabled
----------------------------------	--------------------

# Easergy SC150 Switch Controller Unit

## Fault current detection

### Description:

The directional phase-to-phase short-circuit detection is based on the measurement of 3 phase current (type A and D) and voltage.

It can operate with different types of voltage inputs: refer to the voltage acquisition description.

Logical node name:

**DPHPTOCx**

x being the number of the instance

### Simplified description of the directional phase over-current detection

The phase over-current function in the chosen direction (forwards or backwards) is activated if:

- At least one of the 3 phase currents is higher than the defined threshold ( $I_s$ ) during the tripping time ( $T_s$ )
- The phase shift  $\alpha$  between the current and its voltage polarization is ranged between  $(\theta_0 + 90^\circ)$  and  $(\theta_0 - 90^\circ)$ , where  $\theta_0$  is the characteristic angle

The presence of 2 instances means that 2 directional phase over-current functions can run simultaneously with different settings and/or direction.

## ANSI 67 - Directional phase over-current fault detection

### ANSI 67 - Directional phase over-current Characteristics

Number of instances	2 instances can run simultaneously with different settings
Setting groups	2 groups
Fault current indication	Phase on fault current detected by instance with direction (forwards or backwards)

Setting		
Instance activity		<ul style="list-style-type: none"> <li>• Instance 1: disabled or enabled</li> <li>• Instance 2: disabled or enabled</li> </ul>
Detection mode		<ul style="list-style-type: none"> <li>• Definite Time</li> <li>• Indefinite Time (IDMT):                             <ul style="list-style-type: none"> <li>– IEC standard inverse / A</li> <li>– IEC long time inverse / B</li> <li>– IEC very inverse / B</li> <li>– IEC extremely inverse / C</li> <li>– IEEE moderately inverse</li> <li>– IEEE very inverse</li> <li>– IEEE extremely inverse</li> </ul> </li> </ul>
Over-current threshold (by instance)	DT	From $0.02 I_N$ to $4 I_N$ in 1 A steps
	IDMT	From $0.02 I_N$ to $I_N$ in 1 A steps
Time threshold (by instance)	DT	0.05 s to 300 s in 1 ms steps
	IDMT	0,1 s to 12,5 s in 1 ms steps
Reset time (by instance)	DT	0 to 300s in 1 ms steps
Direction of the fault detected		Backward / Forward
Inrush filter		Disabled / Enabled
Detection angle		$30^\circ$ ; $45^\circ$ or $60^\circ$ (default value $45^\circ$ )

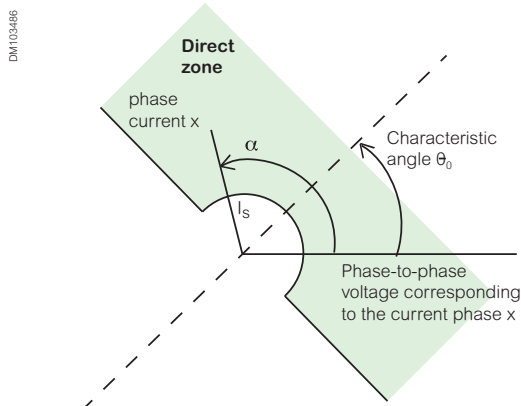



# Easergy SC150 Switch Controller Unit

## Fault Passage Indicator

### Description:

The directional ground short-circuit detection is based on the measurement of residual current measured (type C and D) or calculated (type A and D) and the voltage.

It can operate with different types of voltage inputs: refer to voltage acquisition description.

Logical node name:

**DEfPTOCx**

x being the number of the instance

There are 3 steps to fault detection:

1. The residual voltage must exceed the threshold Minimum residual voltage, during a longer time than Operate delay time threshold.

2. The direction of the fault current is determined by examining the current projected onto the residual voltage.

It is possible also by configuration to only validate faults with a high current peak during this transient phase.

3. The presence of the fault current detected in step 1 is then validated by residual voltage drop.

The presence of 2 instances means that 2 directional phase over-current functions can run simultaneously with different settings and/or direction.

## ANSI 67N:Directional ground fault current detection

### ANSI 67N - Characteristics

Number of instances	2 instances can run simultaneously with different settings
Setting groups	2
Fault current indication	Phase on fault current by instance with direction (forwards or backwards)

### Directional ground over-current setting (by instance): 67

Instance activity	<ul style="list-style-type: none"> <li>• Instance 1: disabled or enabled</li> <li>• Instance 2: disabled or enabled</li> </ul>
Residual current acquisition	<ul style="list-style-type: none"> <li>• <math>I_{res}</math> (by summation of the three phases)</li> <li>• <math>I_0</math> (directly from the core balanced CT)</li> </ul>
$I_0$ (directly from the core balanced CT)	Definite Time
Minimum residual voltage threshold	6 to 30% $V_n$ in 1% steps
Operate delay time	0.05 s to 300 s in 1 ms steps
Reset delay time	0 to 300 s in 1 ms steps
Direction of the fault	Backward / Forward
Validation by residual current and voltage peaks	Disabled / Enabled (current and voltage)
Minimum (blocking) operating current	$I_{res}$ : 0.015 $I_N$ to 2.3 $I_N$ in 1 A steps $I_0$ : 0.01 $I_N$ to 2.3 $I_N$ in 0.5 A from 0.5 A to 10 A then 1 A steps
Minimum (blocking) operating voltage	6 to 60% $V_n$ in 1% steps Only when the sensor is different from a VPIS. This threshold is taken into account only if the validation with sample threshold is enabled

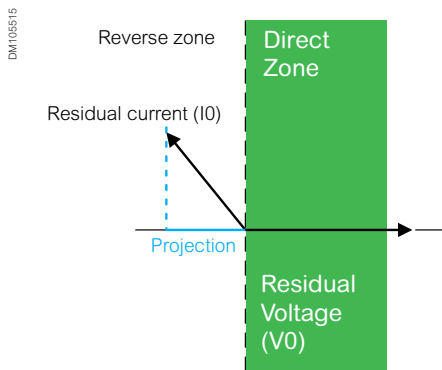

Principle of projecting the residual current onto the residual voltage to determine the direction of the fault current.

# Easergy SC150 Switch Controller Unit

## Network monitoring

### Description:

Detection of phase balances resulting from phase inversion or unbalanced supply, detected by the measurement of negative sequence voltage.

It allows detecting a loss of one or two phases on medium voltage network (broken conductor) and sends an alarm to the control center.

**Associated with ANSI 47, detection on the LV side with LV150, Easergy T300 can detect a blown fuse in the substation (forwards and backwards of the MV/LV transformer).**

Logical node name:

**BcPTOV x**

x being the number of the instance

## ANSI 47 – Negative sequence overvoltage (Voltage broken conductor detection)

### Voltage broken conductor characteristics

Number of instances	2 instances can run simultaneously with different settings
Setting groups	2
Fault current indication	Fault current detected

### Broken conductor setting (by instance)

Instance activity	<ul style="list-style-type: none"> <li>Instance 1: disabled or enabled</li> <li>Instance 2: disabled or enabled</li> </ul>
Phase voltage detection threshold	10 to 100% Vn in 1% step
Operating time delay:	0 to 300 s in 1 ms step
Fault detection reset	<ul style="list-style-type: none"> <li>Reset voltage threshold: 2 to 30% Vn</li> <li>Reset time delay: 0 to 300 s in 1 ms step</li> </ul>

### Description:

Detection of insufficient or unbalanced network voltage to trigger:

Instance 1 et 2 :

- ANSI 27 : Network monitoring (indication)

Instance 3 :

- Network presence for:
  - Fault Passage Indicator validation
  - HMI Network presence indication
  - Automation

### Characteristics:

- Measured quantity is phase-to-phase voltage or phase-to-neutral voltage
- Each phase is monitored

Logical node name:

**AbsPTUV x**

x being the number of the instance

## ANSI 27 – Undervoltage

### Characteristics

Number of instance	3
Setting groups	2
Detection mode	Definite time
Reset ratio (hysteresis)	106%

### Setting

Measured voltage	3 phase-ground
Operation mode	On any phase
Us < threshold	10 to 100% Vn in 1% step
DT time delay	0 ms to 300 s in 1 ms step
Reset time delay	0 to 300 s in 1 ms step

# Easergy SC150 Switch Controller Unit

## Network monitoring

### Description:

Detection of abnormally high network voltage or checking for sufficient voltage to enable:

Instance 1 et 2 :

- ANSI 59 : Network monitoring (indication)

Instance 3 :

- Network presence for:
  - Fault Passage Indicator validation
  - HMI Network presence indication
  - Automation

### Characteristics:

- Measured quantity is single phase
- The voltage presence is set when all phases are confirmed
- The overvoltage presence is set when any phase is on fault detected

Logical node name:

PrsPTOV x

x being the number of the instance

## ANSI 59 – Overvoltage

### Characteristics

Number of instance	3
Setting groups	2
Detection mode	Definite time
Reset ratio (hysteresis)	93%

### Setting

Measured voltage	Phase-ground
Operation mode	On any phase or on all 3 phases
Us < threshold	20 to 200% Vn in 1% step
DT time delay	0 ms to 300 s in 1 ms step
Reset time delay	0 to 300 s in 1 ms step

### Description:

Detection of abnormal voltage by measuring residual voltage to trigger:

Instance 1, 2 and 3:

- ANSI 59N : Residual voltage detection (indication)

### Characteristics:

- Residual voltage can be calculated or measured.

Logical node name:

FPTOV x

## ANSI 59N – Neutral voltage displacement

### Characteristics

Number of instance	3
Setting groups	2
Detection mode	Definite time
Reset ratio (hysteresis)	93%

### Setting

Measured voltage	Phase-phase / phase-ground
Us < Threshold	10 to 200% Un in 1% step (phase-ground)
DT time delay	0 ms to 300 s in 1 ms step
Reset time delay	0 ms to 300 s in 1 ms step

# Easergy SC150 Switch Controller Unit

## Network monitoring

### Description:

Used to confirm network absence on 3 phases to trigger:

- FPI detection confirmation
- Load shedding or source transfer automation for example.
- Network absence indication

### Characteristics:

- Sensitive to the lowest value of the phase currents

## ANSI 37 – Undercurrent

### Characteristics

Number of instance	1 (presence/absence)
Setting groups	1
Reset ratio (hysteresis)	0.2% x In

### Setting

I < Threshold (37)	0.002 In to 0.02 In in 0.1 %
DT time delay	0 ms to 300 s in 1 ms step

Logical node name:

AbsPTUC x

# Easergy SC150 Switch Controller Unit

## Sectionalizer automation

The SC150 can directly manage the sectionalizer automation associated with a Load Break Switch (LBS) for overhead line management.

The LBS can be installed in an underground substation or overhead pole top.

Sectionalizer automation is used on an MV overhead line or an underground to overhead line. It requires a circuit breaker-recloser at the head of the line.

The role of this automation function is to command the opening of the MV switch managed by the SC150 after a defined number of fault currents detected have been detected during an unsuccessful reclose cycle of the upstream recloser. The sectionalizer automation function therefore converts a switch into a sectionalizing switch.

The disconnection logic is used to isolate the section exhibiting the fault condition by opening the switch during the voltage sag of the reclose cycle.

Sectionalizer automation can be enabled individually on each SC150 module on the T300.

The automation function is enabled or disabled globally on the T300 (for all SC150 modules) either remotely from the SCADA system or locally:

- By pressing the "ON" button on the front of the HU250 module
- Via the Web server

### Operation

In normal operating conditions the MV network is energized and the switch is closed.

The automation function sends an open command to the MV switch if:

- Automation is enabled on the channel
- The switch is closed
- The number of fault currents detected counted reaches the number configured (Reclose cycles number)
- The voltage is absent

The automation cycle is reset at the end of the **Primary CB recloser maximum operation time**.

The detected fault currents counter is reset at the end of this time delay.

Automation remains inactive if the number of detected fault currents counted during this time period does not reach the value defined by setting.

The voltage source used to detect the absence of the MV network during the cycle can be acquired and defined in different ways :

- By voltage measurement sensors
- By digital input
- By the AC power supply (in this case, the T300 must be powered by a low voltage source from the MV line on which the switch is installed)

### Blocking Automation

Certain conditions can block the automation function. The automation blocking conditions are associated with any action that makes it impossible to operate the MV switch, namely:

- If the T300 is in local mode and the Enable local mode to block automation option is enabled by configuration
- If the switch interlock digital input is enabled and the External input mode for open commands blocking option is enabled by configuration
- If the switch position is unknown at the time of the command and the Block if switch position is unknown or same as command option is enabled by configuration

DM103487



DM103488

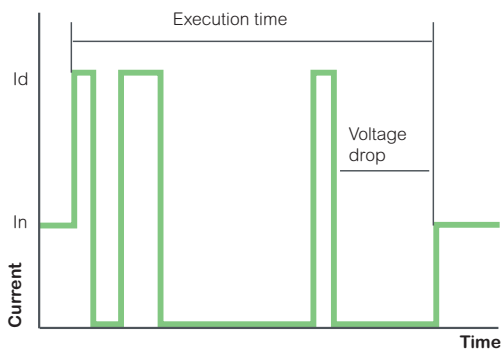

### Characteristics

Setting groups	2 groups
Automation indication	<ul style="list-style-type: none"> <li>• Automation on</li> <li>• Automation off</li> <li>• Automation locked</li> </ul>

### Sectionalizer setting

Sectionalizer active	Enable / Disable
Number of reclose cycles before opening	1 to 4
Maximum execution time after fault detection	20 s to 5 min in 1 s step
Enable lockout on switch operation failure	Enable / Disable
Direction mode	Forward, backward, both

# Easergy SC150 Switch Controller Unit

## Characteristics

Utilities are coming under increasing pressure from both customers and regulatory bodies alike to review the quality of power they are providing (EN50160).

This requires monitoring of their networks for various indices such as number of and duration of outages, dip/swell voltages and system harmonics.

The SC150 offers many high performance capabilities to meter and monitor the MV network with the same current and voltage sensors without the need to add an expensive specialized device.

The SC150 is compliant with IEC 61557-12 for the power measurement and IEC61000-4-30 class S for the power quality.

Easergy T300 has a large capacity of storage for SCADA transmission and/or local consultation. All recorded measurements are consultable via the web server locally or remotely with trends and diagram or table. The measurement log can be also downloaded in Excel format.

Logical node name:

MMXU

## MV measurement

### General characteristics

Standards	
Current, voltage, power and energy	IEC 61557-12/PMD/SD/K70/1

Power quality	IEC61000-4-30 class S
---------------	-----------------------

General	
Current accuracy	0.5% from 0.1 In to 1.2 In
Voltage accuracy	0.5% from 20% Un to 120% Un
Active power	1%
Active energy accuracy	1%
Frequency range	45 to 67 Hz

Current input	
Impedance	1 milliohm
Burden	0.025 VA

### Measured and metered values

	Base	PM option	Power quality option
--	------	-----------	----------------------

#### Instantaneous RMS values

Current: true rms	<ul style="list-style-type: none"> <li>3 phase and residual</li> <li>3 phase average</li> </ul>	% unbalanced
Voltage: true rms	<ul style="list-style-type: none"> <li>3 phase and residual</li> <li>3 phase average</li> </ul>	% unbalanced
Frequency		•
Active, reactive, apparent power (total & per phase)		Signed
Power factor (Total & per phase)		Signed

#### Energy values

Active, reactive, apparent energy		Signed
Configurable accumulation mode		•

#### Demand values

Voltage & current.	•	•
Active, reactive, apparent power		•
Synchronization of the measurement window		•
Demand windows calculation mode		Fixed

# Easergy SC150 Switch Controller Unit

## Characteristics

### Measured and metered values

	Base	Power Meter option	Power Quality option
<b>Other measurements</b>			
Last current demand value before fault detection or switch opening	•		
Last voltage demand value before fault detection	•		
Last voltage value before broken conductor fault detection	•		
<b>Power quality measurement</b>			
Harmonic distortion – current and voltage			• (*)
Individual harmonics – current and voltage			• (*)
Voltage dip and swell events			•
Events			•
Voltage and current unbalance			•
Voltage magnitude			•
<b>Data recording</b>			
Average current rms Min/max : 1 day, 7 days, 1 month, 1 year		•	
Demand values at 3 months		•	
Event logs	•		
Alarms	•		
Counter	•	•	

(\*) Up to H15

# Easergy SC150 Switch Controller Unit

## Characteristics

### Measured and metered values setting

Demand value		
Demand computed mode	Block (synchronized on the T300 RTU clock from the HU250)	
Demand value computed period	Demand value computed period 1, 2, 5, 10, 15, 20, 30, 60 minutes	
Minimum and maximum value	By day, 7 days, 1 month, 1 year	
Power quality Voltage setting		
Voltage swell	Threshold	100% to 150% of Un in 1% steps
Voltage dip	Threshold	5% to 100% of Un in 1% steps
Voltage dip and swell short duration	DT time delay	10 ms to 60 s in 1 ms steps (2 instances of setting for short and long detection)
Voltage interruption	Threshold	1% to 90% of Un in 1% steps
Voltage interruption duration	DT time delay	60 s to 900 s in 1 s steps
Current unbalance	Threshold	1% to 100% of In in 1% steps
	DT time delay	200 ms to 60 s in 1 ms steps
Voltage unbalance	Threshold	1% to 100% of In in 1% steps
	DT time delay	200 ms to 60 s in 1 ms steps



# Easergy SC150 Switch Controller Unit

## Characteristics

### General characteristics

Dielectric compatibility			
Dielectric	IEC 60255-27	Common mode (CM):	<ul style="list-style-type: none"> <li>Insulation (50 Hz/1 min.): 2 kV</li> <li>Surge (1.2/50 <math>\mu</math>s): 5 kV</li> </ul>
Electromagnetic compatibility / Immunity			
Electrostatic discharge	IEC 61000-4-2 Level 4/ Criteria B	15 kV in air 8 kV at contact	
Radiated RF electromagnetic fields	IEC 61000-4-3 Level 4/ Criteria A	30 V/m – 27 MHz to 6 GHz	
Fast transients	IEC 61000-4-4 Level 4/ Criteria A	Power supply, Ethernet	CM: $\pm$ 4 kV 5 kHz – 100 kHz
		Other circuits	CM: $\pm$ 2 kV 5 kHz – 100 kHz
Surge	IEC 61000-4-5 Power supply: Level 4/ Criteria A  Other circuits: Level 3/ Criteria A	<ul style="list-style-type: none"> <li>CM: 2 kV - wave 1.2/50 <math>\mu</math>s</li> <li>DM: 1 kV - wave 1.2/50 <math>\mu</math>s</li> </ul>	
Conducted RF disturbances	IEC 61000-4-6 Level 3/ Criteria A	10 Veff	
		0.15 MHz to 80 MHz	
Power frequency magnetic field	IEC 61000-4-8 Level 5/ Criteria B	<ul style="list-style-type: none"> <li>100 A/m – 50 Hz enduring</li> <li>1000 A/m from 1 to 3 s</li> </ul>	
Immunity to voltage dips	IEC 61000-4-29 Criteria A	Voltage dip:	<ul style="list-style-type: none"> <li>24 Vdc : 100 ms</li> <li>48 Vdc : 500 ms</li> </ul>
		Voltage interruption:	<ul style="list-style-type: none"> <li>24 Vdc : 100 ms</li> <li>48 Vdc : 500 ms</li> </ul>
Pulse magnetic field immunity	IEC 61000-4-9 Level 5/ Criteria A	1000 A/m	
Conducted common mode disturbance	IEC 61000-4-16 Level 4/ Criteria A	CM: 30 V for 15 Hz to 150 kHz 300 V during 1 s	
Damped oscillatory waves	IEC 61000-4-18 Level 3/ Criteria A	CM: 100 kHz, 1 MHz, 3 MHz, 10 MHz, 30 MHz - 2 kV	
Emission tests			
Radiated disturbances	CISPR22	Class A (EN5502)	

**Criteria A definition:** The unit shall continue to operate as intended during and after the test. No degradation of performance or loss of function is allowed below a performance level specified by the manufacturer, when the apparatus is used as intended. The performance level may be replaced by a permissible loss of performance.

**Criteria B definition:** The unit shall continue to operate as intended after the test. No degradation of performance or loss of function is allowed below a performance level specified by the manufacturer, when the apparatus is used as intended. The performance level may be replaced by a permissible loss of performance. During the test, degradation of performance is however allowed. No change of actual operating state or stored data is allowed.

# Easergy SC150

## Switch Controller Unit

### Characteristics

#### General characteristics

Environmental conditions		
Operating temperature	IEC 60068-2-1	-40° C to +70° C
	IEC 60068-2-2	
Storage temperature	IEC 60068-2-1	-40° C to +85° C
	IEC 60068-2-2	
Damp heat, steady state	IEC 60068-2-78	93% RH, 40°C, RH no condensation , 56 days
Change of temperature	IEC 60068-2-14	-40° C to +70° C, 5° C/min, 10 Cycles, 27 h without condensation
Damp heat, cyclic	IEC 60068-2-30	144 h: 6 cycles of 24 h (+55° C, 93% HR during 9 h; +25° C, 95% HR during 6 h)
Salt spray test	IEC 60068-2-11	168 h
Product safety standards		
Protection of persons and goods	IEC 60255-27	
Fire resistance	IEC 60695-2-11	850° C
Power supply		
Rated supply voltage		12...48 Vdc (+/-20 %)
Power consumption		< 2 VA

#### Mechanical characteristics

Degree of protection	IEC 60529	<ul style="list-style-type: none"> <li>• Front cabinet: IP4x</li> <li>• Module body: IP2x</li> </ul>
Robustness	IEC 62262	IK7 2 J
Vibrations	IEC 60068-2-6	10 - 2000 Hz / 1g (peak value) 10 cycles
Bumps	IEC 60068-2-29	10 g / 16 ms / 1000 Bumps "non energized"
Shocks	IEC 60068-2-27	10 Gn / 11 ms / 3 pulses "in operation"
Weight		0.515 kg
Dimensions (H x W x D)		140 mm x 45 mm x 140 mm

Notes

---

# Easergy LV150

## Low Voltage monitoring

# Easergy LV150

## Low Voltage monitoring

### General description

Easergy LV150 is the right answer to optimize the Low Voltage (LV) network management and assets. It helps you to:

- Detect LV unbalanced or Phase losses (MV or LV issue)
- Reduce the LV outages durations
- Measure the energy power flow with LV distributed generation
- Manage the peak load with exhaustive data
- Help ensure the efficiency and reliability of your network and equipment
- Reduce transformer faults and extend life
- Monitor the power quality deliver according to EN50160 directive
- Avoid the loss of neutral issues

The Easergy LV150 is an unmatched low voltage monitoring module designed for the public MV/LV substation. It combines accurate 3-phase energy and power measurements with data logging, power quality analysis, alarming and temperature capabilities not typically available in such a compact RTU.

The Easergy LV150 is compliant with stringent international standards that enhance its metering accuracy and power quality measurements, as specified by the safety standard requirement for the MV/LV substation.

Easergy LV150 gives you the energy intelligence and control needed to track performance, stay informed in real time of critical conditions and empower you to make strategic decisions. It will help you increase reliability, maximize the use of resources and improve service. The main functions of LV150 are:

- Transformer temperature monitoring
- LV incomer power monitoring
- LV incomer power quality monitoring
- LV network voltage fault detection (loss of neutral at transformer level)

## Current measurement and monitoring

The LV150 has a fourth CT for measuring of 3 phases and direct neutral current measurement. In demanding utilities applications, where loads are non-linear and the cable size of the neutral is not the same as those of the phases, measuring neutral current is necessary to avoid overload and loss of neutral. In addition, the LV150 provides measured and calculated ground current value, not available in meters with 3 CTs.

## Voltage measurement and monitoring

The voltage inputs are designed according to over-voltage Category IV define in IEC60255-27 for the MV/LV distribution substation.

- 6kVrms 1min / 10kVrms 1s
- 20kV choc (1.2/50  $\mu$ s)

The LV150 to measure the 3 phases (L-N) and neutral/ground voltage for power metering, power quality and voltage monitoring as:

- Broken conductor detection (ANSI 47): detection of one phase loss due to the MV or LV site broken conductor or fuse blown
- Undervoltage (ANSI 27)
- Overvoltage (ANSI 59)



### LV150 Part Number

Reference	Description
EMS59300	LV150 module
EMS59574	AC voltage adapter

# Easergy LV150

## Low Voltage monitoring

### General description

---

#### Power measurements

according to IEC 61557-12/PMD/SD/K70/1

- Voltage and current RMS values
- Min/max current RMS on 1 day, 7 days, 1 month 1 year)
- Real, apparent and reactive power in four quadrants for knowing the energy power flow with distributed generation
- Energy value received and delivered
- THD on voltage and current per phase
- Individual harmonics tension and current including neutral that can harm transformer and cable connection.
- Demand value for following peak demands with time stamping.

#### Power quality

according to IEC61000-4-30 class S

- Power quality monitoring with supply magnitude, voltage dip and swell, voltage unbalance and harmonic voltage.
- Voltage unbalance
- Voltage magnitude

#### Transformer monitoring

- Temperature monitoring and alarm
- Peak load measurement

# Easergy LV150

## Low Voltage monitoring

### General description

### Local operator front panel (HMI)

#### Display of information by coloured LEDs

- Module status
- Alarm status

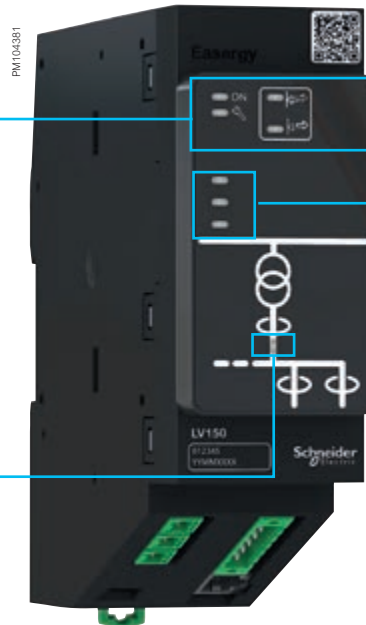

3 customisable LEDs

#### FPI and voltage indications

- Voltage presence status

#### Daisy chain LAN

- Internal Ethernet LAN for Easergy T300 modules
- Ethernet 10/100 Base

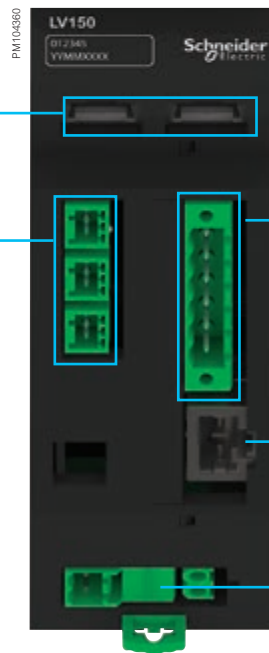

#### Current acquisition

- 3 phase and neutral acquisition

#### 3 temperature sensors inputs

- Measurement:
  - 55°C to 250°C (-67°F to 482°F)
- Resolution: 1°C (1°F)
- 3 analog inputs for connection of 3 wire PT100 temperature sensors

#### Voltage acquisition

- 3 phase and neutral acquisition through a voltage adapter

#### Daisy chain power supply

- 12-48 Vdc

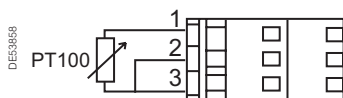

# Easergy LV150

## Low Voltage monitoring

### Connection

- The Low voltage acquisition 3 phases and neutral is done through an AC resistive divider voltage adapter in order to help ensure the high level of voltage insulation
- The LV voltage adapter can be installed in the LV switchboard with its protection and connected to the LV150 by Ethernet RJ45 cable. The maximum length is 4m with cable type (S/STP or S/FTP)
- Nevertheless, the LV150 can be also installed in the LV switchboard and connected to internal Ethernet communication to Easergy T300 by Ethernet cable

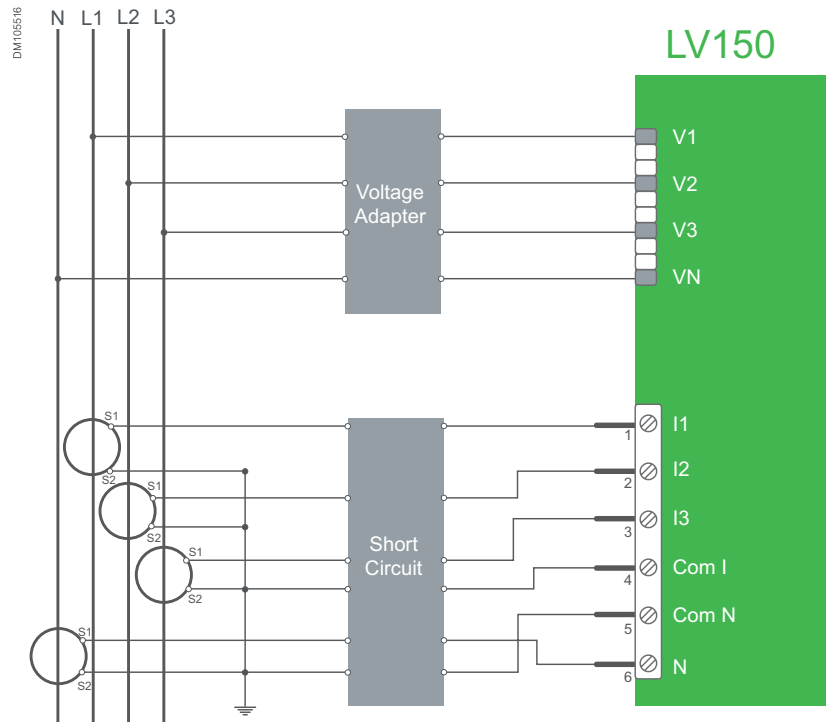

Connection example



Voltage adapter for LV150 (ref: EMS59574)

#### Ethernet RJ45 cable connected between voltage adapter and LV150

Description	Length (maximum 4 m)	Reference
Cable type	CCA770 0.6 m	59660
S/STP	CCA772 2 m	59961
or S/FTP	CCA774 4 m	59962



# Easergy LV150

## Low Voltage monitoring

### Network monitoring

#### Description:

Detection of phase balances resulting from phase inversion or unbalanced supply, detected by the measurement of negative sequence voltage.

It allows detecting a loss of one or two phases on medium voltage network (broken conductor) and sends an alarm to the control center.

**Associated with ANSI 47, detection on the MV side with SC150 , Easergy T300 can detect a blown fuse in the substation (forwards and backwards MV/LV transformer)**

Logical node name:

**BcPTOV x**

x being the number of the instance

## ANSI 47 – Negative sequence overvoltage (Voltage broken conductor detection)

#### Voltage broken conductor characteristics

Number of instances	2 instances can run simultaneously with different settings
Setting groups	2
Fault indication	Fault detected

#### Broken conductor setting (by instance)

Instance activity	<ul style="list-style-type: none"> <li>Instance 1: disabled or enabled</li> <li>Instance 2: disabled or enabled</li> </ul>
Phase voltage detection threshold	10 to 100% Vn in 1% step
Operating time delay:	0 to 300 s in 1 ms step
Fault detection reset	<ul style="list-style-type: none"> <li>Reset voltage threshold: 2 to 30% Vn</li> <li>Reset time delay: 0 to 300 s in 1 ms step</li> </ul>

#### Description:

Detection of insufficient or unbalanced network voltage to trigger:

Instance 1 et 2 :

- ANSI 27 : Network monitoring (indication)

Instance 3 :

- HMI Network presence indication

#### Characteristics:

- Measured quantity is phase-to-phase voltage or phase-to-neutral voltage.
- Each phase is monitored.

Logical node name:

**AbsPTUV x**

x being the number of the instance

## ANSI 27 – Undervoltage

#### Characteristics

Number of instance	3
Setting groups	2
Detection mode	Definite time
Reset ratio (hysteresis)	106%

#### Setting

Measured voltage	3 phase-ground
Operation mode	On any phase
Us < threshold	10 to 100% Un in 1% step
DT time delay	0 ms to 300 s in 1 ms step
Reset time delay	0 to 300 s in 1 ms step

# Easergy LV150

## Low Voltage monitoring

### Network monitoring

#### Description:

Detection of abnormally high network voltage or checking for sufficient voltage to enable:

Instance 1 et 2 :

- ANSI 59 : Network monitoring (indication)

Instance 3 :

- HMI Network presence indication

#### Characteristics:

- Measured quantity is single phase
- The voltage presence is set when all phases are confirmed
- The overvoltage presence is set when any phase is on fault current detection

Logical node name:

**PrsPTOV x**

x being the number of the instance

## ANSI 59 – Overvoltage

#### Characteristics

Number of instance	3
Setting groups	2
Detection mode	Definite time
Reset ratio (hysteresis)	93%

#### Setting

Measured voltage	Phase-ground
Operation mode	On any phase or on all 3 phases
Us < threshold	20 to 200% Un in 1% step
DT time delay	0 ms to 300 s in 1 ms step
Reset time delay	0 to 300 s in 1 ms step

#### Description:

Detection of abnormal voltage by measuring residual voltage to trigger:

Instance 1, 2 and 3:

- ANSI 59N : Residual voltage detection (indication)

#### Characteristics:

- Residual voltage can be calculated or measured.

Logical node name:

**FPTOV x**

## ANSI 59N – Neutral voltage displacement

#### Characteristics

Number of instance	3
Setting groups	2
Detection mode	Definite time
Reset ratio (hysteresis)	93%

#### Setting

Measured voltage	Phase-phase / phase-ground
Us < Threshold	10 to 200% Un in 1% step (phase-ground)
DT time delay	0 ms to 300 s in 1 ms step
Reset time delay	0 ms to 300 s in 1 ms step

# Easergy LV150

## Low Voltage monitoring

### Characteristics

#### Electrical characteristics

##### Input-voltage (with voltage adapter)

Network	3 phases and neutral
Nominal voltage	L - L : 190 to 400 Vac
Frequency	45 to 67Hz
Impedance	10 MΩ

##### Input-current

Nb of current input	4 current inputs: 3 phases and neutral with different setting for phase and neutral
Primary rated value	50 to 3000 A
Rated nominal current	1A or 5A
Current measurement range	0.01 to 7 In (rated nominal current)
Permissible overload	<ul style="list-style-type: none"> <li>• 10 A In continuous</li> <li>• 50 A In-10s per hour</li> <li>• 120A -1s</li> </ul>
Impedance	1 milliohm
Burden	0.025 VA

##### Input-analog

Type	3 analog 3 wire PT100 temperature sensors
Measurement range	-55 to 250°C (-67°F to 482°F)
Resolution	1°C (1°F)
Accuracy	1%

##### Power supply

Voltage input	12V to 48V dc (-15%, +20%)
Burden	3 VA; max typical: 1,5 VA

#### Current acquisition setting

##### Input-current setting

Primary phase CT rated	Adjustable from 50 A to 3000 A in 1A step
Primary neutral CT rated	Adjustable from 50 A to 3000 A in 1A step

# Easergy LV150

## Low Voltage monitoring

### Characteristics

Utilities are coming under increasing pressure from both customers and regulatory bodies alike to review the quality of power they are providing (EN50160).

This requires monitoring of their networks for various indices such as number of and duration of outages, dip/swell voltages and system harmonics.

The LV150 offers many high performance capabilities to meter and monitor the MV network with the same current and voltage sensors without the need to add an expensive specialized device.

The LV150 is compliant with IEC 61557-12 for the power measurement and IEC IEC1000-4-30 for the power quality.

Easergy T300 has a large capacity of storage for SCADA transmission and/or local consultation. All recorded measurements locally are consultable via the web server locally or remotely with trends and diagram or table. The measurement log can be also downloaded in Excel format.

Logical node name:

**MMXU**

## LV measurement

### General characteristics

Current, voltage, power and energy	IEC 61557-12/PMD/SD/K70/1
Power quality	IEC6000-4-30 class S
Current accuracy	0.5% from 0.1 In to 1.2 In
Voltage accuracy	0.5% from 20% Un to 120% Un
Active power	1%
Active energy accuracy	1%
Frequency range	45 to 67 Hz

### Measured and metered values

	PM	Power quality option
--	----	----------------------

#### Instantaneous RMS values

Current: true rms	<ul style="list-style-type: none"> <li>3 phases and neutral</li> <li>3 phases and neutral average</li> </ul>	% unbalanced
Voltage: true rms	<ul style="list-style-type: none"> <li>3 phases and neutral</li> <li>3 phases and neutral average</li> </ul>	% unbalanced
Frequency	•	
Active, reactive, apparent power (total & per phase)	Signed	
Power factor (Total & per phase)	Signed	

#### Energy values

Active, reactive, apparent energy	Signed
Configurable accumulation mode	•

#### Demand values

Voltage & current.	•
Active, reactive, apparent power	•
Synchronization of the measurement window	•
Demand windows calculation mode	Fixed

# Easergy LV150

## Low Voltage monitoring

### Characteristics

#### Measured and metered values

	PM	Power quality option
<b>Other measurements</b>		
Last current demand value before fault detection or switch opening	•	
Last voltage demand value before fault detection	•	
Last voltage value before broken conductor fault detection	•	
<b>Power quality measurement</b>		
Harmonic distortion – current and voltage		• (*)
Individual harmonics – current and voltage		• (*)
Voltage dip and swell events		•
Events		•
Voltage unbalance		•
Voltage magnitude		•
<b>Data recording</b>		
Average current rms Min/max : 1 day, 7 days, 1 month, 1 year	•	
Demand values at 3 months	•	
Event logs	•	
Alarms	•	
Counter	•	

(\*) Up to H15

# Easergy LV150

## Low Voltage monitoring

### Characteristics

#### Measured and metered values setting

Demand value		
Demand computed mode	Block (synchronized on the T300 RTU clock from the HU250)	
Demand value computed period	Demand value computed period 1, 2, 5, 10, 15, 20, 30, 60 minutes	
Minimum and maximum value	By day, 7 days, 1 month, 1 year	
Power quality Voltage setting		
Voltage swell	Threshold	100% to 150% of $U_n$ in 1% steps
Voltage dip	Threshold	5% to 100% of $U_n$ in 1% steps
Voltage dip and swell short duration	DT time delay	10 ms to 60 s in 1 ms steps (2 instances of setting for short and long detection)
Voltage interruption	Threshold	1% to 90% of $U_n$ in 1% steps
Voltage interruption duration	DT time delay	60 s to 900 s in 1 s steps
Current unbalance	Threshold	1% to 100% of $I_n$ in 1% steps
	DT time delay	200 ms to 60 s in 1 ms steps
Voltage unbalance	Threshold	1% to 100% of $I_n$ in 1% steps
	DT time delay	200 ms to 60 s in 1 ms steps

# Easergy LV150

## Low Voltage monitoring

### Characteristics

#### General characteristics

Dielectric compatibility			
Dielectric	IEC 60255-27	Common mode (CM):	<ul style="list-style-type: none"> <li>Insulation (50 Hz/1 min.): 2 kV</li> <li>Surge (1.2/50 <math>\mu</math>s): 5 kV</li> </ul>
Electromagnetic compatibility / Immunity			
Electrostatic discharge	IEC 61000-4-2 Level 4/ Criteria B	15 kV in air 8 kV at contact	
Radiated RF electromagnetic fields	IEC 61000-4-3 Level 4/ Criteria A	30 V/m – 27 MHz to 6 GHz	
Fast transients	IEC 61000-4-4 Level 4/ Criteria A	Power supply, Ethernet	CM: $\pm$ 4 kV 5 kHz – 100 kHz
		Other circuits	CM: $\pm$ 2 kV 5 kHz – 100 kHz
Surge	IEC 61000-4-5 Power supply: Level 4/ Criteria A  Other circuits: Level 3/ Criteria A	<ul style="list-style-type: none"> <li>CM: 2 kV - wave 1.2/50 <math>\mu</math>s</li> <li>DM: 1 kV - wave 1.2/50 <math>\mu</math>s</li> </ul>	
Conducted RF disturbances	IEC 61000-4-6 Level 3/ Criteria A	10 Veff	
		0.15 MHz to 80 MHz	
Power frequency magnetic field	IEC 61000-4-8 Level 5/ Criteria B	<ul style="list-style-type: none"> <li>100 A/m – 50 Hz enduring</li> <li>1000 A/m from 1 to 3 s</li> </ul>	
Immunity to voltage dips	IEC 61000-4-29 Criteria A	Voltage dip:	<ul style="list-style-type: none"> <li>24 Vdc : 100 ms</li> <li>48 Vdc : 500 ms</li> </ul>
		Voltage interruption:	<ul style="list-style-type: none"> <li>24 Vdc : 100 ms</li> <li>48 Vdc : 500 ms</li> </ul>
Pulse magnetic field immunity	IEC 61000-4-9 Level 5/ Criteria A	1000 A/m	
Conducted common mode disturbance	IEC 61000-4-16 Level 4/ Criteria A	CM: 30 V for 15 Hz to 150 kHz 300 V during 1 s	
Damped oscillatory waves	IEC 61000-4-18 Level 3/ Criteria A	CM: 100 kHz, 1 MHz, 3 MHz, 10 MHz, 30 MHz - 2 kV	
Emission tests			
Radiated disturbances	CISPR22	Class A (EN5502)	

**Criteria A definition:** The unit shall continue to operate as intended during and after the test. No degradation of performance or loss of function is allowed below a performance level specified by the manufacturer, when the apparatus is used as intended. The performance level may be replaced by a permissible loss of performance.

**Criteria B definition:** The unit shall continue to operate as intended after the test. No degradation of performance or loss of function is allowed below a performance level specified by the manufacturer, when the apparatus is used as intended. The performance level may be replaced by a permissible loss of performance. During the test, degradation of performance is however allowed. No change of actual operating state or stored data is allowed.

# Easergy LV150

## Low Voltage monitoring

### Characteristics

#### General characteristics

Environmental conditions		
Operating temperature	IEC 60068-2-1	-40° C to +70° C
	IEC 60068-2-2	
Storage temperature	IEC 60068-2-1	-40° C to +85° C
	IEC 60068-2-2	
Damp heat, steady state	IEC 60068-2-78	93% RH, 40°C, RH no condensation , 56 days
Change of temperature	IEC 60068-2-14	-40° C to +70° C, 5° C/min, 10 Cycles, 27 h without condensation
Damp heat, cyclic	IEC 60068-2-30	144 h: 6 cycles of 24 h (+55° C, 93% HR during 9 h; +25° C, 95% HR during 6 h)
Salt spray test	IEC 60068-2-11	168 h
Product safety standards		
Protection of persons and goods	IEC 60255-27	
Fire resistance	IEC 60695-2-11	850° C
Power supply		
Rated supply voltage		12...48 Vdc (+/-20 %)
Power consumption		< 2 VA

#### Mechanical characteristics

Degree of protection	IEC 60529	<ul style="list-style-type: none"> <li>• Front cabinet: IP4x</li> <li>• Module body: IP2x</li> </ul>
Robustness	IEC 62262	IK7 2 J
Vibrations	IEC 60068-2-6	10 - 2000 Hz / 1g (peak value) 10 cycles
Bumps	IEC 60068-2-29	10 g / 16 ms / 1000 Bumps "non energized"
Shocks	IEC 60068-2-27	10 Gn / 11 ms / 3 pulses "in operation"
Weight		0.46 kg
Dimensions (H x W x D)		140 mm x 45 mm x 140 mm



Notes

---

# Easergy PS50, PS25 Power Supply

# Easergy PS50, PS25 Power Supply

## General description

The Easergy T300 backup power supplies are designed for long power supply interruption and to maintain control and monitoring of the entire MV substation during outages.

### High-availability backup power supply range for control and monitoring applications

Designed to supply all components in the substation including switchgear mechanics and motors

- Designed for severe environments with a high level of insulation
- Designed for very long outage times
- Easy maintenance with only one battery



PS25



PS50

## Easergy PS50, PS25 Power supply

Depending on the version, the power supply provides backup operating power for long power supply interruptions for:

- MV switchgear motor mechanisms and circuit breaker coils
- Transmission devices (e.g., radio)
- Electronic modules of T300
- Third-party devices such as protection relays, fault passage indicators and other electronic devices

### Two power supply models are adapted to various applications and to various sizes of T300:

	PS25	PS50
12 V IEDs		36 W
12 V Telecom		18 W
24 V / 48 V permanent (IEDs)		10 W
Peak for motor: With battery		300 W
Single output 12 V	48 W	
Single output 24 V	48 W	

*Power available for each voltage output depending on the version*

### Power supply part numbers

Type	Reference	Description
PS25-12 V	EMS58585	12 V for monitoring
PS25-24 V	EMS58586	24 V for monitoring
PS50-24 V	EMS58587	24 V motor for controller
PS50-48 V	EMS58588	48 V motor for controller

### Battery part numbers

Type	Reference	Description
BAT24 AH	EMS58582	12 V - 24 Ah; 10 years
BAT38 AH	EMS58583	12 V - 38 Ah; 10 years
BAT5.5 AH	EMS58589	12 V - 5.5 Ah; 12 years
BAT2.5 AH	EMS58584	12 V - 2.5 Ah; 5 years

# Easergy PS50, PS25 Power Supply

## General description

### Designed for severe environments:

The Easergy PS50 is ideal for isolated sites that are regularly struck by lightning.

- 10 kV insulation and 20 kV surge
- Protected against neutral cutout
- High temperature range: -40° C to 70° C

### and easy maintenance:

- Only an unique battery (PS50 and PS25-12) for easy maintenance and robust lifespan (> 10 years)
- Battery end-of-life monitoring for preventive maintenance

### Recommended power supply by application

- PS50 for controller solution
  - High availability due to the separate voltage output for IEDs, telecom and motor
  - High efficiency and high energy backup autonomy
  - PS50 is the power supply in our packaged solution
  - Embedded high insulation
- PS25 for monitoring solution
  - High autonomy with small battery
  - PS25 is the power supply in our packaged solution

### Power supply and battery

- Battery charging and monitoring for long battery life
  - Temperature-compensated charger
  - Charging current limitation
- Prevention against serious discharge
  - Protection against deep discharge
  - Protection against over voltage
- Battery availability check (PS50)
  - Periodic battery test
  - Battery status indication
  - Capacity indication

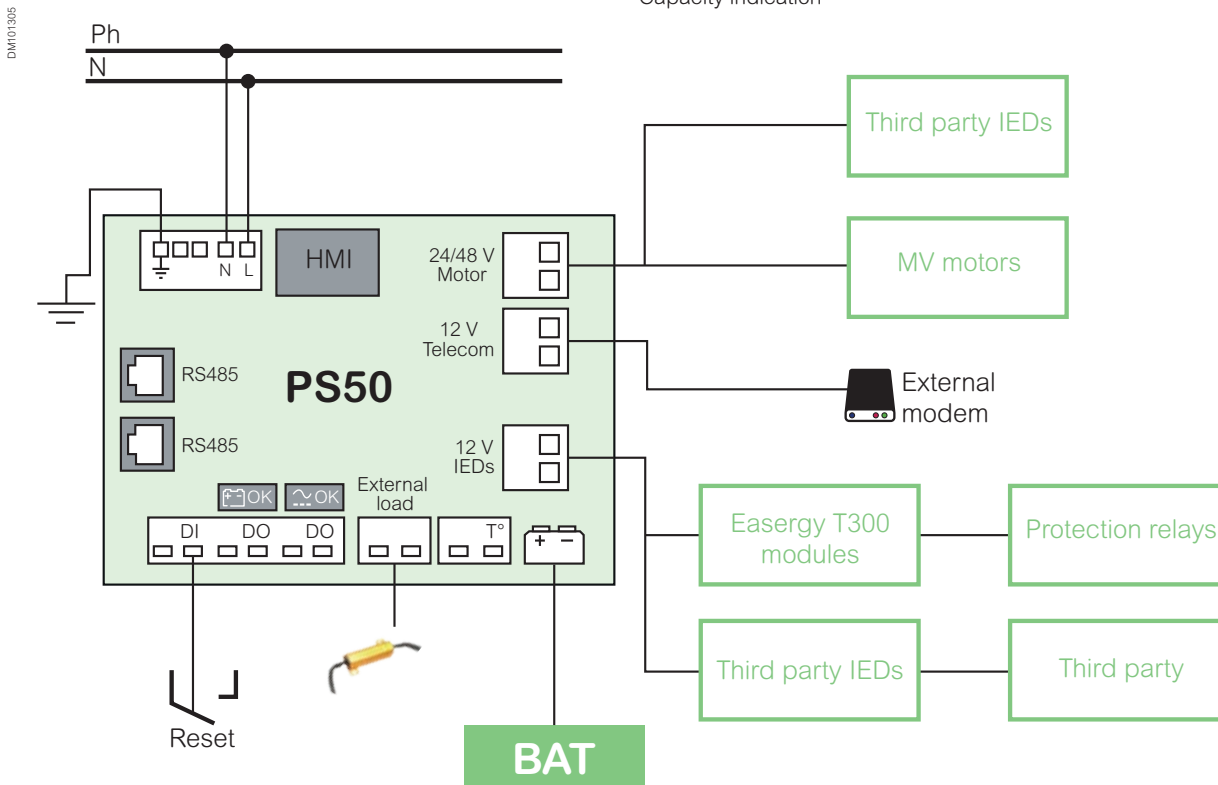

Example of power supply application with PS50

# Easergy PS50, PS25 Power Supply

## Power supply selection guide

	PS50	PS25	
		12 V	24 V
			

### Application

Controller	•		
Monitor	•		•

### Easergy T300 module size

Number of Modules	Up to 16	Up to 20
-------------------	----------	----------

### Output voltage

12 Vdc dedicated to IEDs	•	•	•
12 Vdc for Telecom devices	•		
24 Vdc or 48Vdc for switchgear motor and IEDs	•		

### Input voltage

AC voltage input	90 to 264 Vac - 50/60 Hz single phase	85 to 264 Vac - 47/63 Hz single phase
DC voltage input	110 to 220 Vdc	110 to 345 Vdc
Over voltage	Up to 440 Vac	

### Output characteristics

12 Vdc IEDs	Rated output power	36 W	48 W	48 W
	Rated output voltage	12 V (10.5 V to 15 V)	10 Vdc to 16 Vdc	22.5 Vdc to 29.5 Vdc
	Continuous current	3 A	4 A	2 A
	Overload limit	8 A	7 A	3 A
	Short circuit peak current	13 A – 50 ms		
	Output overvoltage protection	15.5 V	< 35 Vdc	35 Vdc
12 Vdc telecom	Rated output voltage	12 V (10.5 V to 15 V)		
	Rated output power	18 W		
	Continuous current	1.5 A		
	Overload limit	8 A		
	Short circuit peak current	13 A -50 ms		
	Output overvoltage protection	15.5 V		
48 or 24 Vdc motor and IEDs		<b>24 V</b>	<b>48 V</b>	
	Rated output voltage	24 V ± 10%	48 V ± 10%	
	Rated output power	10 W		
	Continuous current	0.4 A	0.2 A	
	Overload limit	3 A	1.5 A	
	Short circuit peak current	40 A	40 A	
	Rated output power	300 W (60s max)		
	Rated output current	30 A-50 ms then 12 A-15 s	15 A-50 ms then 6 A-15 s	
	Output overvoltage protection	27 V	55 V	

# Easergy PS50, PS25 Power Supply

## Power supply selection guide

	PS50	PS25	
		12 V	24 V
			

### Voltage output monitoring

12 Vdc Telecom	The output can be switched off on the current load and time thresholds, in order to disconnect a radio locked in permanent transmission (latch up).	Configurable: Enable / Disable Current: 0.2 to 4 A Duration: 1 s to 5 min	
24 V or 48 V output	V output interruption management: activated only for motor control	•	
12 Vdc IEDs	Sleep mode management	•	

### Voltage output protection (all voltage outputs)

Overload and short circuit	•	•
Over temperature	•	•
Over-voltage	•	•

### Battery management

Number of batteries	1	1	2
Charger capacity	Up to 38 Ah	Up to 10 Ah	
Battery type	Sealed lead maintenance free type		
	Rated voltage	10.5 V to 15 V	9.6 to 13.6 Vdc 19.2 to 27.9 Vdc
Battery charging control	Max charging current	Battery type configurable: 38 AH, 24 AH or others <38 AH 0.8 A	
	Temperature compensated from internal T° measurement	•	
	Charging time	10 h to 24 h	3 h to 24 h
Battery protection	Against serious discharge	•	9.6 V 19.2 V
	Against short circuit	•	•
	Against reverse polarity connection	•	•
Battery test	Battery test on internal load (AC and DC method)	•	•
	Battery test on dedicated external load <sup>(*)</sup>	•	
	Automatic periodic tests	•	
	Activated by communication	•	
Battery monitoring	Detection of battery end of life	•	•
	Detection of battery connection/disconnection	•	
Energy backup management	Sleep mode	•	
	Sleep mode timer configurable	•	
	Wake-up by network returns	•	
	Wake-up by push button	•	
	Wake-up by digital input	•	



### Local HMI (LED on the power supply)

Power input absence	•	•
Equipment status	•	•
48 V/24 V power supply status	•	
12 V IED power supply status ON	•	
12 V telecom power supply status ON	•	
Battery status detected or battery end of life	•	•
Modbus communication status	•	

(\*) Consult us for availability



# Easergy PS50, PS25 Power Supply

## Power supply selection guide

	PS50	PS25	
		12 V      24 V	
			
<b>Auxiliary contact</b>			
Battery status	•		
Battery is ON		•	
AC supply ON (voltage presence)	•	•	
Relay type - breaking capacity	60 Vdc – 2 A	1 A / 30 V	
<b>Voltage output protection (all voltage outputs)</b>			
Overload and short circuit	•	•	
Over temperature	•	•	
Overvoltage	•	•	
<b>Communication and monitoring Protocol</b>			
Communication via Modbus RS485	•		
<b>Voltage and current output measurement</b>			
12 V IEDs output	Current measurement Voltage measurement	• •	
12 V telecom output	Current measurement Voltage measurement	• •	
24/48 V motor output	Current measurement Voltage measurement	• •	
Battery voltage output	Current measurement Voltage measurement	• •	
<b>Status information</b>			
AC supply voltage presence	•	•	
12 V and 48 V or 24 V output issue	•		
Battery monitoring	Battery disconnected	•	
	Battery is under charge	•	•
	Battery is in float mode	•	•
	Battery is discharging	•	•
	Battery charge level indicator	•	
	Battery status	•	•
	Serious discharge alarm	•	
Battery low	•	•	
Time-stamped events	100 events		
<b>Settings</b>			
AC voltage presence and loss (threshold)	•		
Battery monitoring: low voltage threshold	•		
Battery monitoring: deep discharge threshold (serious discharge)	•		
Battery charger parameter	•		
Battery test period	•		
Battery nominal capacity	•		
Energy backup enable/ Disable	•		
Energy backup threshold	•		
Energy backup time duration	•		

# Easergy PS50, PS25 Power Supply

## Power supply selection guide

	PS50	PS25
		12 V 24 V
		
<b>Commands</b>		
Restart 12 V -48 V/24 V (Energy Backup)	•	
<b>Mechanical</b>		
Weight	2.75 kg	0.45 kg
Dimensions (H x W x D)	190 x 270 x 71 mm	99 x 67.5 x 115 mm
	Vertical	Vertical
<b>Temperature</b>		
Operating temperature range	-40 °C to +70 °C	-25°C to 70°C
Storage temperature range	-40 °C to +70 °C	-40°C to +85°C
<b>Battery</b>		
Brand	Yuasa	5.5 Ah: Sonneschein 2.5 Ah: Yuasa
Voltage/ampereage	12 V -24 Ah 12 V -38 Ah	12 V - 5.5 Ah 12 V - 2.5 Ah
Type	Lead acid	
Lifespan	10 years	5.5 Ah: 12 years 2.5 Ah: 5 years
Storage temperature	-20 to +60 °C	
Charging temperature	-15 to +50 °C	
Discharging temperature	-20 to +60 °C	
Weight	SWL1100: 14 kg SWL750: 9 kg	<3 kg



# Easergy PS50, PS25 Power Supply

## Battery autonomy

Easergy T300 backup power supplies are designed to provide power during a long outage.

The battery autonomy depends on:

- The Easergy T300 configuration (number of modules)
- The external IED load
- The type of telecom devices and the cycle of communication with the control center
- The characteristics of the MV switchgear motor mechanism and the number of open / close cycles
- The type and capacity of the batteries
- The environment conditions (temperature, battery age, etc.)

In order to extend the battery autonomy in a long power interruption situation, PS50 can enter a sleep mode.

The backup energy thus saved can help ensure an additional open/close operation (plus associated communications) of the MV switchgear when power is restored.

The following examples of energy backup duration are based on the following loads:

- Different configuration of Easergy T300 (number of modules)
- Motor consumption
- Communication consumption

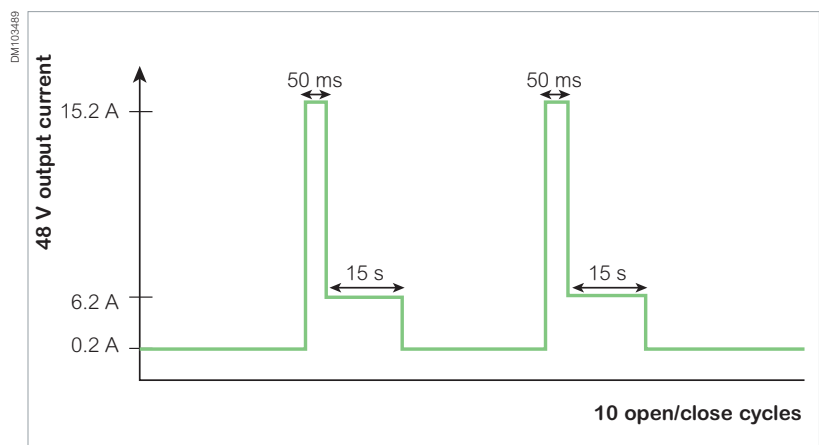

- Telecom consumption

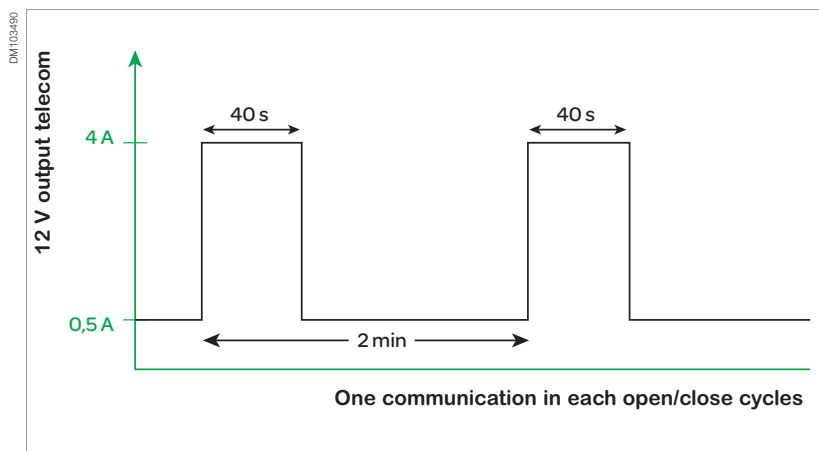

- Temperature: 20° C

# Easergy PS50, PS25 Power Supply

## Battery autonomy

Example of power outage cycle and battery autonomy with PS50

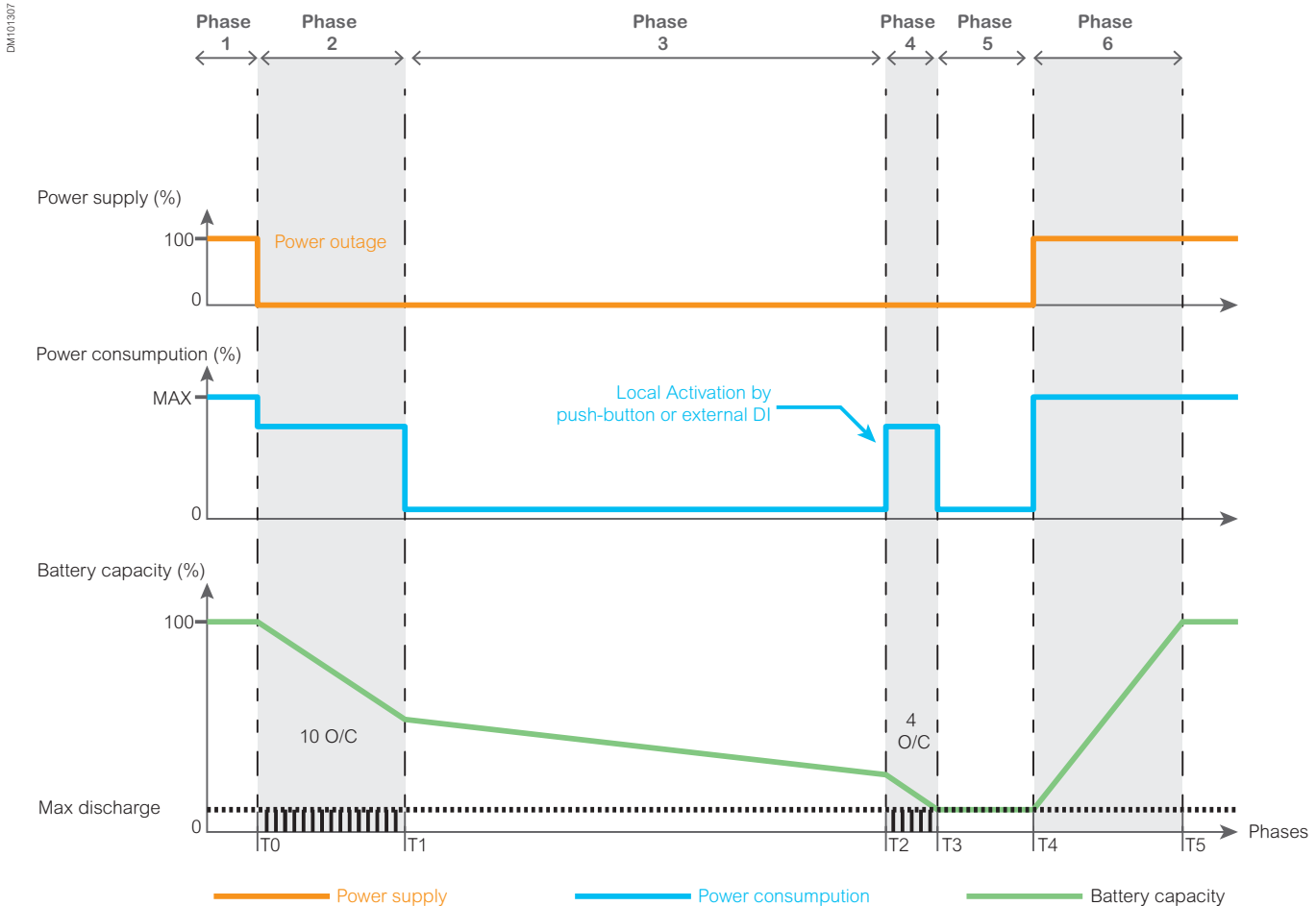

### Phase 1

AC supply present and the battery is fully charged

### Phase 2: Power outage

- Power supply absent, all loads are supplied from the battery
- Up to 10 open/close (O/C) operations are executed on MV switch motorization during this phase
- One control center radio communication for each O/C cycle

### Phase 3: Sleep mode

- After a period of time (configurable), the sleep mode is activated to preserve battery capacity
- The voltage outputs are shut down and low power consumption mode is activated

### Phase 4: Wake-up

- The power supply is awakened by pressing the button or via the external digital input
- Up to 4 O/C operations on the motorization are performed during this period
- One control center radio communication in each O/C cycle

### Phase 5: Deep sleep

When the minimum discharge threshold is reached, the power supply enters deep sleep mode

### Phase 6: AC supply is back

Power supply indicates an abnormal condition until battery capacity is above a certain threshold, the PS50 is again in Power On mode

# Easergy PS50, PS25 Power Supply

## Battery autonomy

Example of PS50 autonomy for each battery type, depending on presence of sleep mode and wake-up mode

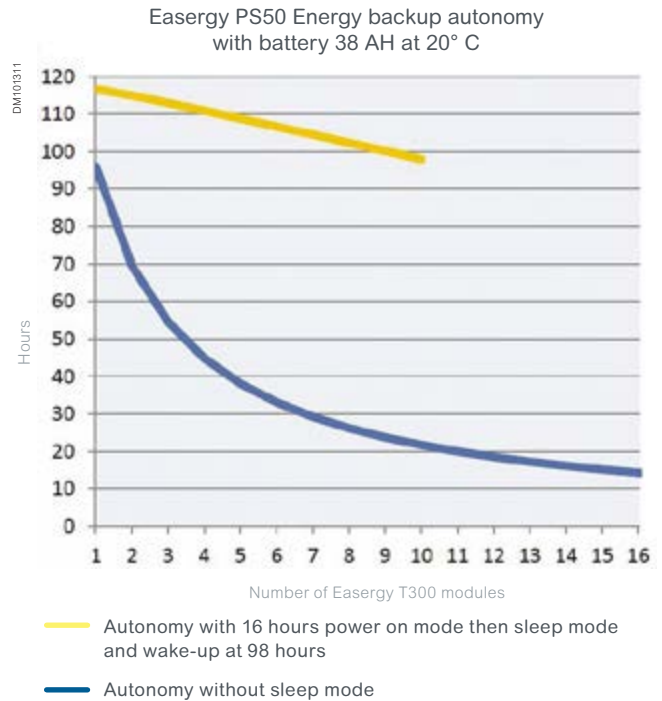
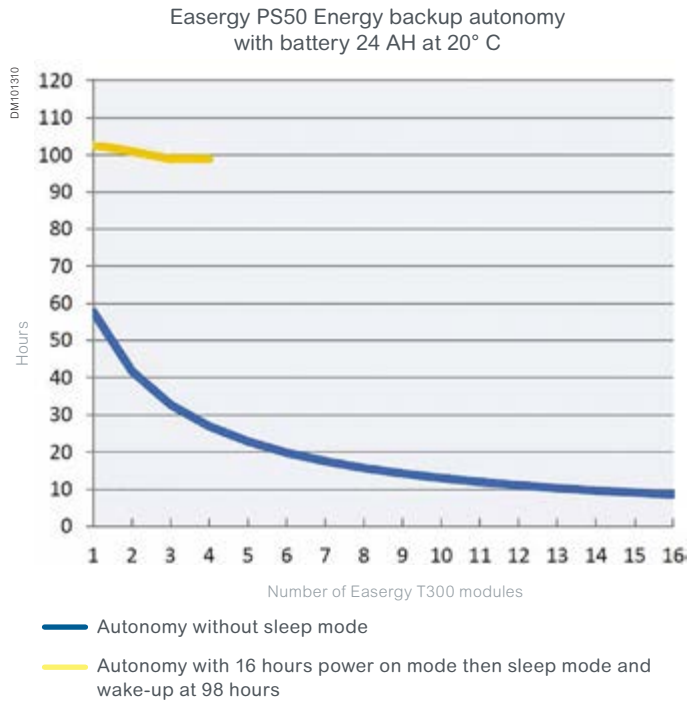

Example of autonomy for PS50 and PS25 without sleep mode, depending on battery type

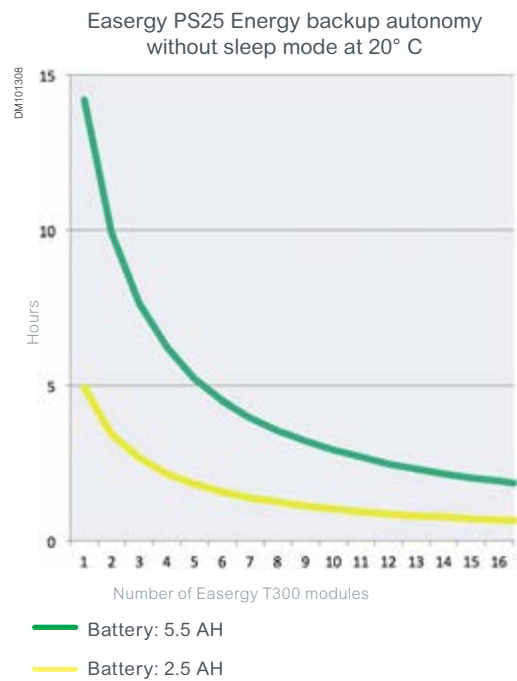
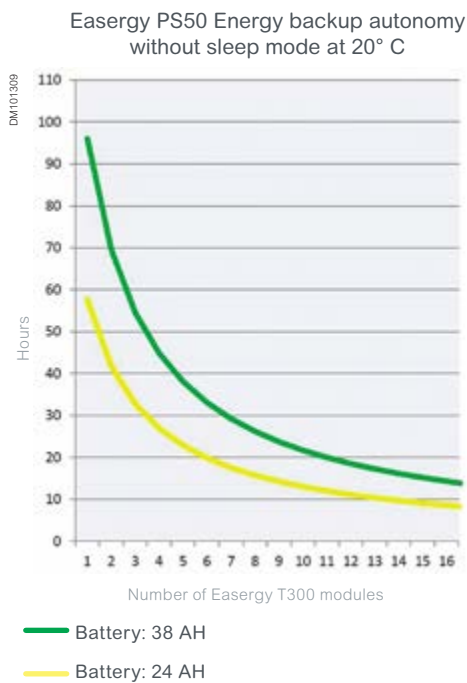

# Easergy PS25 Power Supply

## Characteristics

### General characteristics

<b>Electrostatic discharge</b>	<b>EN 61000-4-2</b>
Housing	Level 3
Contact discharge	6 kV
Discharge in air	8 kV
Comments	Criterion B
<b>Electromagnetic HF field</b>	<b>EN 61000-4-3</b>
Housing	Level 3
Frequency range	80 MHz ... 2 GHz
Field intensity	10 V/m
Comments	Criterion A
<b>Fast transients (burst)</b>	<b>EN 61000-4-4</b>
Input	4 kV (level 4 - asymmetrical: conductor to ground)
Output	2 kV (level 3 - asymmetrical: conductor to ground)
Signal	1 kV (level 2 - asymmetrical: conductor to ground)
Comments	Criterion B
<b>Surge current loads (surge)</b>	<b>EN 61000-4-5</b>
Input	4 kV (level 4 - asymmetrical: conductor to ground) 2 kV (level 4 - symmetrical: conductor to conductor)
Output	2 kV (Level 3 - asymmetrical) 1 kV (Level 3 - symmetrical)
Signal	2 kV (Level 3 - asymmetrical) 1 kV (Level 3 - symmetrical)
Comments	Criterion B
<b>Conducted interference</b>	<b>EN 61000-4-6</b>
Input/Output/Signal	Level 3
Frequency range	10 kHz ... 80 MHz
Voltage	10 V
Comments	Criterion A

**Criteria A definition:** The unit shall continue to operate as intended during and after the test. No degradation of performance or loss of function is allowed below a performance level specified by the manufacturer, when the apparatus is used as intended. The performance level may be replaced by a permissible loss of performance.

**Criteria B definition:** The unit shall continue to operate as intended after the test. No degradation of performance or loss of function is allowed below a performance level specified by the manufacturer, when the apparatus is used as intended. The performance level may be replaced by a permissible loss of performance. During the test, degradation of performance is however allowed. No change of actual operating state or stored data is allowed.

# Easergy PS25 Power Supply

## Characteristics

### General characteristics

Insulation voltage input/output	
In accordance with EN 50178 and EN 60950	2 kV (routine test) 4 kV (type test)
Ambient conditions	
Ambient temperature (operation)	-25 °C ... 70 °C (> 60 °C derating)
Ambient temperature (storage/transport)	-40 °C ... 80 °C
Max. permissible relative humidity (operation)	95 % (at 25 °C, no condensation)
Vibration (operation)	< 15 Hz, amplitude ±2.5 mm in acc. with IEC 60068-2-6 15 Hz ... 150 Hz, 2.3g, 90 min.
Shock	30g in all directions in acc. with IEC 60068-2-27
Pollution degree in acc. with EN 50178	2
Climatic class	3K3 (in acc. with EN 60721)
Standards	
Electrostatic discharge	EN 61000-4-2
Electromagnetic HF field	EN 61000-4-3
Fast transients	EN 61000-4-4
Surge current loads	EN 61000-4-5
Conducted interference	EN 61000-4-6
Electrical Equipment for machinery	EN 60204
Safety transformers for power supply units	EN 61558-2-17
Electrical safety (of information technology equipment)	EN 60950/VDE 0805 (SELV) EN 61558-2-17
Electronic equipment for use in electrical power installations	EN 50178/VDE 0160 (PELV)
SELV	EN 60950 (SELV) EN 60204 (PELV)
Safe isolation	DIN VDE 0100-410 DIN VDE 0106-1010
Protection against electric shock, basic requirements for safe isolation in electrical equipment	DIN VDE 0106-101
Approvals	
UL approvals	UL Listed UL 508 UL/C-UL Recognized UL 60950
Mechanical characteristics	
Degree of protection	IP20
Class of protection	II (in an enclosed control cabinet)
MTBF	> 500 000 h in acc. with IEC 61709 (SN 29500)
Type of housing	Polyamide PA, color: green
Weight	0.45 kg
Dimensions H / W / D (state of delivery)	99 mm / 67.5 mm / 115 mm

# Easergy PS50 Power Supply

## Characteristics

### General characteristics

Dielectric compatibility			
Dielectric	IEC 60255-27	AC supply inputs	<ul style="list-style-type: none"> <li>CM: Insulation (50 Hz/1 min.): 10 kV</li> <li>CM: Surge (1.2/50 µs): 20 kV</li> <li>DM: Surge (1.2/50 µs): 8 kV</li> </ul>
		Others	<ul style="list-style-type: none"> <li>CM: Insulation (50 Hz/1 min.): 2 kV</li> <li>CM: Surge (1.2/50 µs): 5 kV</li> <li>DM: Insulation (50 Hz/1 min.): 1 kV</li> <li>DM: Surge (1.2/50 µs): 3 kV</li> </ul>
Emission tests			
Radiated disturbances	CISPR22	Class A (EN5502)	
Conducted disturbances	CISPR22	Class A (EN5502)	
Electromagnetic compatibility / Immunity			
Electrostatic discharge	IEC 61000-4-2	15 kV in air	
	Level 4 / Criteria B	8 kV at contact	
Radiated RF electromagnetic fields	IEC 61000-4-3	30 V/m – 27 MHz to 6 GHz	
Fast transients	IEC 61000-4-4	AC supply Output V, RS485	CM: ±4 kV (L4) 5 kHz – 100 kHz
		Other circuits	CM: ±2 kV (L3) 5 kHz – 100 kHz
Surge	IEC 61000-4-5	AC supply input	<ul style="list-style-type: none"> <li>CM: 4 kV (L4) - wave 1.2/50 µs</li> <li>DM: 2 kV (L4) - wave 1.2/50 µs</li> </ul>
		Others	<ul style="list-style-type: none"> <li>CM: 2 kV (L3) - wave 1.2/50 µs</li> <li>DM: 1 kV (L3) - wave 1.2/50 µs</li> </ul>
Conducted RF disturbances	IEC 61000-4-6	10 Veff	
	Level 3 / Criteria A	0.15 MHz to 80 MHz	
Power frequency magnetic field	IEC 61000-4-8	<ul style="list-style-type: none"> <li>100 A/m – 50 Hz enduring</li> <li>1000 A/m from 1 to 3 s</li> </ul>	
	Level 5 / Criteria B		
Pulse magnetic field	IEC 61000-4-9	1000 A/m	
	Level 5 / Criteria A		
Conducted common mode disturbance	IEC 61000-4-16	CM: 30 V for 15 Hz to 150 kHz 300 V during 1 s	
	Level 4 / Criteria A		
Damped oscillatory waves	IEC 61000-4-18	CM: 100 kHz, 1 MHz, 3 MHz, 10 MHz, 30 MHz - 2 kV	
	Level 3/ Criteria A		

**Criteria A definition:** The unit shall continue to operate as intended during and after the test. No degradation of performance or loss of function is allowed below a performance level specified by the manufacturer, when the apparatus is used as intended. The performance level may be replaced by a permissible loss of performance.

**Criteria B definition:** The unit shall continue to operate as intended after the test. No degradation of performance or loss of function is allowed below a performance level specified by the manufacturer, when the apparatus is used as intended. The performance level may be replaced by a permissible loss of performance. During the test, degradation of performance is however allowed. No change of actual operating state or stored data is allowed.

# Easergy PS50 Power Supply

## Characteristics

### General characteristics

Environmental conditions		
Operating temperature	IEC 60068-2-1	-40°C to +70°C
	IEC 60068-2-2	
Storage temperature	IEC 60068-2-1	-40° C to +70°C
	IEC 60068-2-2	
Damp heat, steady state	IEC 60068-2-78	93% RH, 40° C, RH no condensation , 56 days
Change of temperature	IEC 60068-2-14	-40°C to +70°C , 1°C/min , 10 cycles , 27 h without condensation
Damp heat, cyclic	IEC 60068-2-30	144 h: 6 cycles of 24 h (+55°C, 93% HR during 9 h; +25°C, 95% HR during 6 h)
Salt spray test	IEC 60068-2-11	168 h
Product safety standards		
Protection of persons and goods.	IEC 60255-27	
Insulation resistance	IEC 60255-27	• 500 V CM & DM
		• R>100 MΩ
Fire resistance	IEC 60695-2-11	850°C
Flame retardant	IEC 60695-11-5	• Flame application: 5 times 15 s each.
		• Interval between each application: 15 s or 1 time 30 s
Protective bounding continuity	IEC 60255-27	12 V , <0.1 Ω, 60 s

### Mechanical characteristics

Degree of protection	IEC 60529	IP20
Robustness	IEC 62262	IK7 2 J
Vibrations	IEC 60068-2-6	10 to 2000 Hz / 1g (peak value) 10 cycles
Bumps	IEC 60068-2-29	10 g / 16 ms / 1000 Bumps "non energized"
Shocks	IEC 60068-2-27	10 Gn / 11 ms / 3 pulses "in operation"
Weight		2.75 kg
Dimensions H / W / D (state of delivery)		190 x 270 x 71 mm

# Easergy PS50, PS25 Power Supply

## Installation

PS50 and PS25 are DIN rail mounted for easy integration in any MV/LV substation (e.g., low voltage compartment of the MV switchgear).

PS50 includes on its front face a DIN rail, to which T300 modules can easily be attached.

### PS50

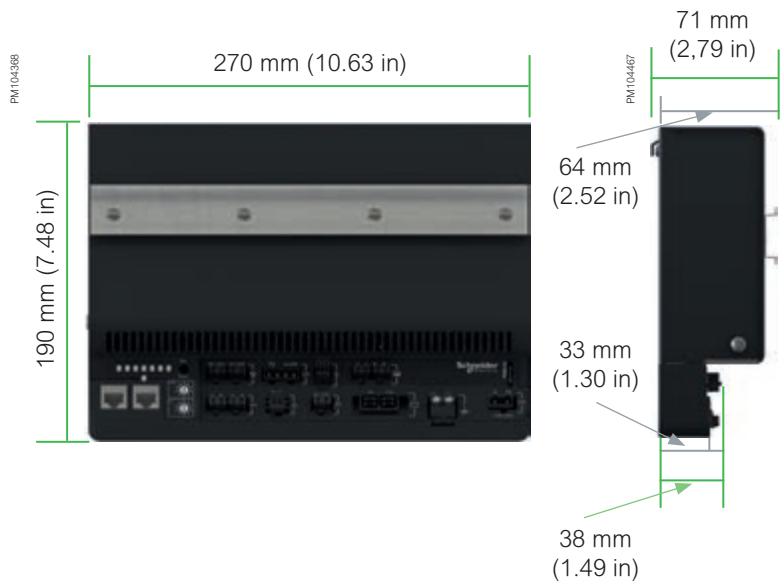

### PS25





Notes

---

# Cabinet and Smart RMU Solution

# Cabinet and Smart RMU Solution

---

<b>Ready-to-use solution Catalog</b>	<b>100</b>
General description	100
T300-IV1 cabinet	101
T300-OVR cabinet	102
T300-OM1 cabinet	103
Smart RMU offer	104

---

# Ready-to-use solution Catalog

## General description

Information presented on front panels is visible through a window, without opening the door.



### Ready-to-use cabinet solution

- A selection of ready-to-use cabinets is available off-the-shelf for fast delivery and installation.
- Cabinets are also modular and flexible in order to offer a just-right solution
- The web configurator allows you to quickly build your configuration (hardware and software)

T300 is offered as a compact Feeder RTU solution standardized in a complete cabinet build and corresponding to the standard requirements of an MV/LV substation. These solutions are modular and can be adapted to the specific requirements.

All configurations can be extended on-site with different Easergy T300 modules. You can consult our Engineering Centers to design or customize a dedicated solution.

Three types of enclosure are available as standard, depending on the installation environment:

- Indoor controller cabinet
- Outdoor controller cabinet, wall-mounted or pole-mounted
- Indoor and outdoor monitoring, wall-mounted or pole-mounted

Three types of enclosure are offered as standard:

- T300-IV1: Vertical wall-mounted cabinet for indoor applications
- T300-OVR: Vertical wall-mounted cabinet for outdoor applications
- T300-OM1: Indoor and outdoor medium monitor cabinet (consult us for availability)



Indoor Vertical version – T300-IV1

# Ready-to-use solution Catalog

## T300-IV1 cabinet

**Modules assembled on a DIN rail including:**

- 1 Power Supply PS50
- 1 Front Head Unit HU250
- 1 to 4 modules Switch Controller SC150



Reserved for one LV150 module

1 AC 1Ph+N breaker

1 battery 24 Ah or 38 Ah

Terminal 10 points switch connectors are mounted to the underside of the enclosure.

**A pre-configured flange**

is available on the lower part. This flange includes cut-out cable gland plates and so enables installation of any size of cable with any diameter. This flange is IP65 degree of protection.

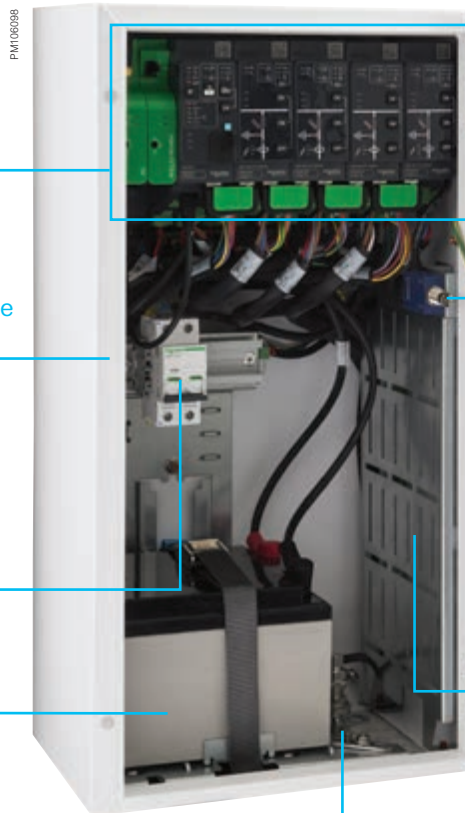

T300-IV1 cabinet  
Indoor Vertical version

**Optional**

**Opened door contact**

Connected internally to a digital input, it enables remote indications of the door status (open/closed).

**CTs easy access plug**

The connections of the CTs are normally made directly on the SC150 modules themselves. This option enables centralization of the CT connections for the unit's SC150 modules in a more accessible location on the right-hand side of the enclosure.

**Transmission plate**

A free space for installation of external transmission devices

- Height = 300 mm
- Width = 60 mm
- Depth = 220 mm

This space includes a metallic plate (optional) for the installation of a radio or modem.

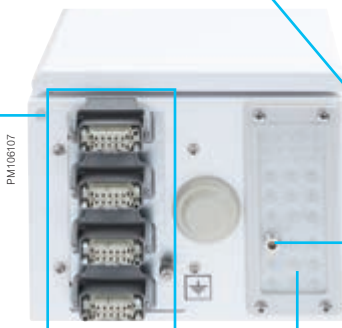

**Antenna surge arrester**

For GSM/3G or radio purposes, it helps prevent surge and deterioration due to antenna overvoltage.

**T300-IV1 Characteristics**

• **Dimensions**

- Basic enclosure:  
H 600 x W 310 x D 250 mm
- Basic enclosure + 10 point connectors:  
H 640 x W 310 x D 250 mm

- **Weight:** 40 kg
- **Material:** Metallic
- **Mounting:** Wall-mounted, vertically
- **Protection indice:** IP31 - IK07
- **Paint color reference:** RAL 9003

# Ready-to-use solution Catalog

## T300-OVR cabinet

**Modules assembled on a DIN rail including:**

- 1 Power Supply PS50
- 1 Front Head Unit HU250
- 1 to 4 modules Switch Controller SC150

**1 AC 1Ph+N breaker**



Reserved for one LV150 module

**1 battery 24 Ah or 38 Ah**

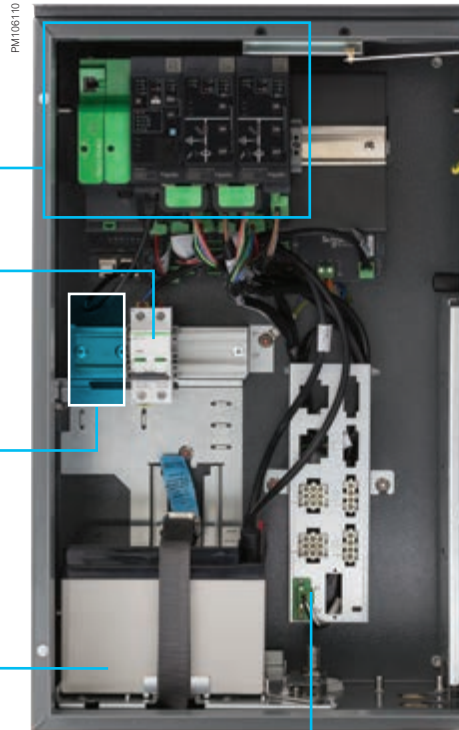

T300-OVR cabinet  
Outdoor Vertical version

**Optional**

**Opened door contact**

Connected internally to a digital input, it enables remote indications of the door status (open/closed).

**Antenna surge arrester**

For GSM/3G or radio purposes, it helps prevent surge and deterioration due to antenna overvoltage.

Ringmaster specific  
AMP switch and current  
transformer connectors

**Connection**

- All cable access is located on the lower part of the enclosure
- An adjustable sliding plate at the lower part of the enclosure facilitates entry to the switch and current cables and also locks the cable glands
- All switch and current cable connections are compatible with the Ringmaster standard



**T300-OVR Characteristics**

• **Dimensions**

Basic enclosure:  
H 600 x W 380 x D 275 mm

• **Weight:** 40 kg

• **Material:** Metallic

• **Mounting:**

- Wall-mounted, vertically
  - The enclosure can be attached to the Ringmaster using the standard T200E mounting kit

• **Protection indice:** IP54 - IK09

• **Paint color reference:** RAL 7012

# Ready-to-use solution Catalog

T300-OM1 cabinet (consult us for availability)

## Modules assembled on a DIN rail including:

- 1 Front Head Unit HU250
- 1 to 5 modules Switch Controller SC150

Reserved for one more optional SC150

1 AC 1Ph+N breaker

1 Battery 5,5 Ah or 2,5 Ah

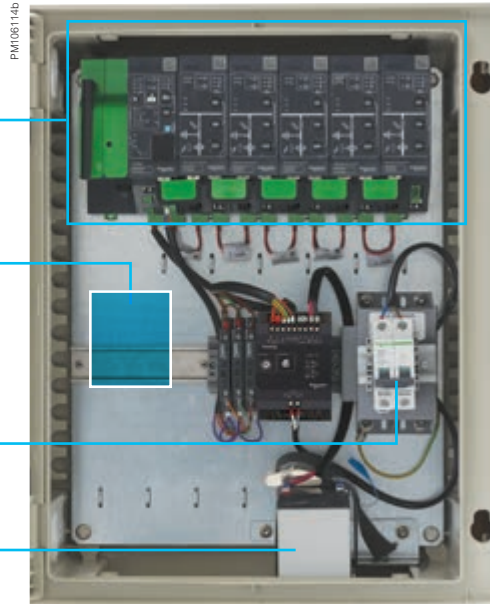

T300-OM1 cabinet  
Outdoor version

## Optional

### Opened door contact

Connected internally to a digital input, it enables remote indications of the door status (open/closed).

## Connection

All cable access is located on the lower part of the enclosure.



## T300-OM1 Characteristics

- **Dimensions**  
Basic enclosure:  
H 530 x W 430 x D 200 mm
- **Weight:** 40 kg
- **Material:** Polyester
- **Mounting:**  
Wall-mounted or pole-mounted, vertically
- **Protection indice:** IP54 - IK09
- **Paint color reference:** RAL 7012

## Smart RMU: Best-in-class technologies in one solution

- Built on decades of electrical distribution experience, the smart RMU is robustly engineered to provide superior safety and reliability – even in the harshest environment.
- Easy to install and operate, a fully SF6-insulated smart RMU is:
- Embedded with safety features, such as rotating arc technology\* and visible earthing contact
- Protected by standard or custom metal enclosure for indoor or outdoor\* installation
- Enriched with smart interfaces for self-powered relays, fault passage indicators (FPIs), and sensors
- Compliant with the latest IEC standards for connectivity, automation schemes, and cybersecurity

\*Available for Ringmaster and RM6

## Sensors for the smart RMU

The smart ring main unit includes a set of fully integrated sensors for voltage, power, current, and temperature monitoring. For faster and simpler on-site assembly, the sensors are pre-installed where possible (due to application some sensors are supplied in kit form).

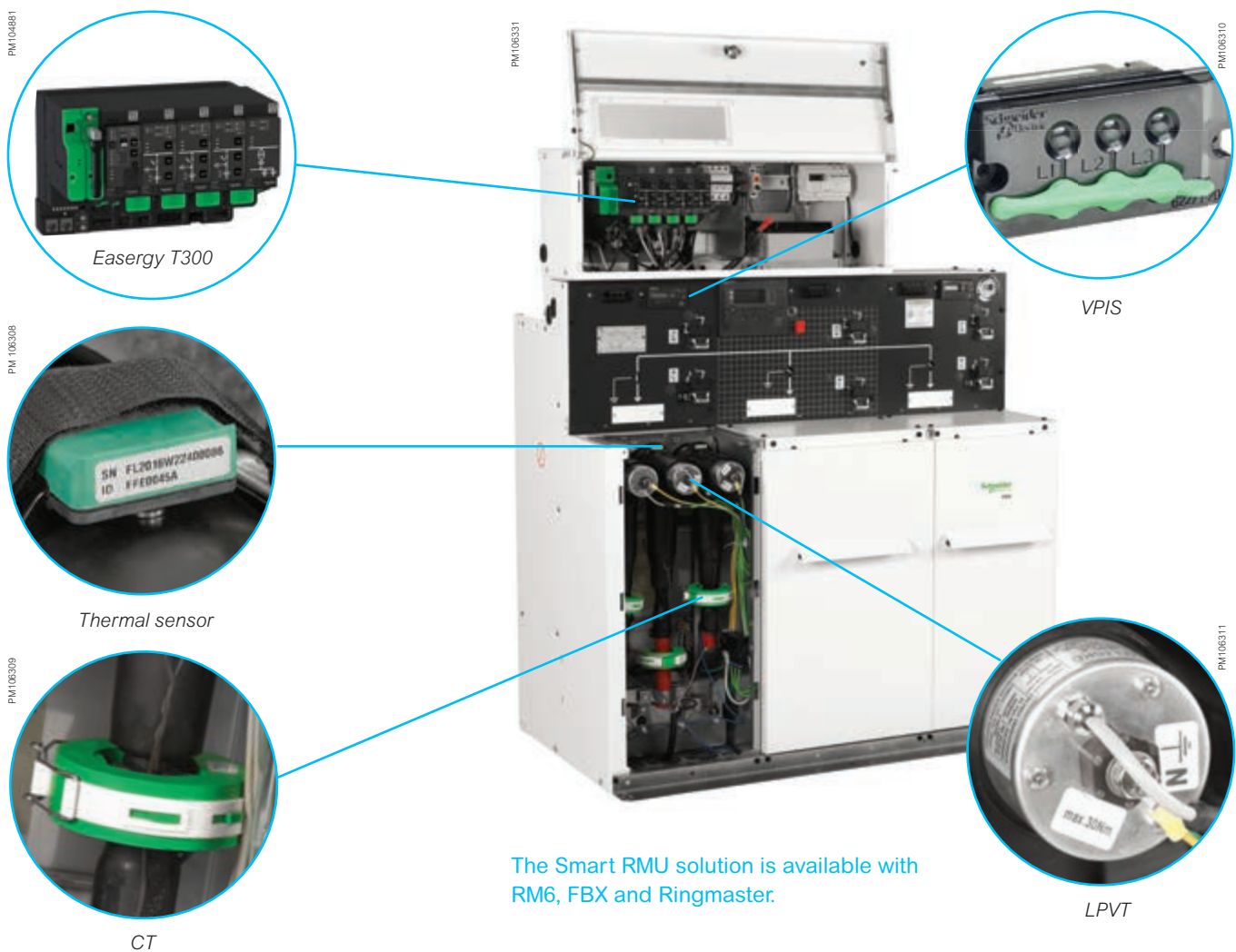

The Smart RMU solution is available with RM6, FBX and Ringmaster.



Notes

---

# Accessories





# Accessories

Voltage adapter	108
CT current transformer	110
Installation accessories	111

# Easergy T300 Voltage adapter

## MV Voltage adapter

The different MV sensors used with the SC150 are summarized in the table below. Each type of voltage sensor requires a specific adapter (available as an option) for connection to the SC150 module:

	Description	Part #
 <p>PM106126</p>	<p><b>Voltage adapter for VTs</b></p> <ul style="list-style-type: none"> <li>Voltage inputs                             <ul style="list-style-type: none"> <li>U rated value: LN 22V to 240V - LL 38V to 400 V</li> </ul> </li> <li>Product safety standards                             <ul style="list-style-type: none"> <li>IEC/EN 61010-1 ed.3, CAT III, 400 V L-N / 690 V L-L</li> <li>UL 61010-1 ed.3 and CSA-C22.2 No. 61010-1 ed.3, CAT III, 347 V L-N / 600 V L-L</li> <li>IEC/EN 62052-11, protective class II</li> </ul> </li> <li>Standard insulation                             <ul style="list-style-type: none"> <li>Common mode: 2.5 kV (50 Hz, 1 min) 5 kV (1.2/50 μs)</li> <li>Differential mode: 4 kV (1.2/50 μs)</li> </ul> </li> <li>IP 30</li> </ul>	EMS59572
 <p>PM106129</p>	<p><b>VDS Adapter</b></p> <ul style="list-style-type: none"> <li>Voltage input: LL from 1 V to 30 V max</li> <li>IP: IP 30</li> </ul>	EMS59571
 <p>PM106128</p>	<p><b>VPIS Adapter</b></p> <ul style="list-style-type: none"> <li>Voltage input: LL from 1 V to 30 V max</li> <li>IP 30</li> </ul>	EMS59570
 <p>PM106127</p>	<p><b>PPACS Adapter</b></p> <ul style="list-style-type: none"> <li>Voltage input: LL from 1 V to 30 V max</li> <li>Cable length: 54 cm</li> <li>IP 30</li> </ul>	EMS59575
 <p>PM106130</p>	<p><b>LPVT RJ45-RJ45 sensors Hub</b></p> <ul style="list-style-type: none"> <li>Mounting: Din rail and plastic clamp</li> <li>Size: 90x45x35 mm</li> <li>IP 30</li> </ul>	EMS59573

# Easergy T300

## Voltage adapter

### LV Voltage adapter

The LV150 voltage measurement requires a specific adapter (available in spare part) for connection to the module. This Voltage adapter helps ensure the insulation level needed in the MV/LV substation.



Description	Part #
<b>AC Voltage adapter for LV150</b> <ul style="list-style-type: none"> <li>• Voltage inputs           <ul style="list-style-type: none"> <li>– U rated value: LN 22V to 240V - LL 38V to 400 V</li> </ul> </li> <li>• Product safety standards           <ul style="list-style-type: none"> <li>– IEC/EN 61010-1 ed.3, CAT III, 400 V L-N / 690 V L-L</li> <li>– UL 61010-1 ed.3 and CSA-C22.2 No. 61010-1 ed.3, CAT</li> <li>– III, 347 V L-N / 600 V L-L</li> <li>– IEC/EN 62052-11, protective class II</li> </ul> </li> <li>• Standard insulation           <ul style="list-style-type: none"> <li>– Common mode: 10 kV (50 Hz, 1 s), 6 kV (50 Hz, 1 min) 5 kV (1.2/50 μs)</li> <li>– Differential mode: 4 kV (1.2/50 μs)</li> </ul> </li> <li>• IP 30</li> </ul>	EMS59574

# Easergy T300 CT current transformer

PM104250



Resinated phase split core CT, class 1 (ref. EMS58183) or class 3 (ref. EMS58175)

PM104500



Resinated split core balanced CT (ref. EMS58111)

PM106347



CT AMP connector to screw connector adapter (ref. EMS58130)

PM104654



Current sensors connection cable with AMP connectors (ref. EMS58132 to 137)

Easergy T300 can be used with standard CT compliant with IEC61869, part 1 + 2 for the MV measurement (fault current detection and power measurement) and LV measurement.

The current sensors used for measuring can be 1A or 5A secondary with security factor limiting the current to 100A secondary -1s.

### Accuracy class

It consists in controlling the right adaptation of the CT on the accuracy class aspect.

The total dissipated power of the measurement circuit (T300 + cables) should not be greater than the specified limit of the CT. This limit is for different standard classes. If necessary, the choice of the cable section, the CT should be modified to fit the requirement.

Refer to the Burden of current input of SC150 and LV150 : impedance input = 1milliOhms.

The following split core CT are designed mainly for retrofit. A large range of CT are available in Schneider Electric Catalogue.

You can consult us for more information and additional split core CT solution.

### MV and LV current sensors

MV current sensor characteristics	Phase current sensors	Phase or core balanced current sensors
Standard	IEC61869-1	
Internal diameter	50 mm	150 mm
External diameter	110 mm	190 mm
Thickness	35 mm	45 mm
Primary CT rating	500 A	
Type of CT	Split-core and closed CT	Split-core CT
Secondary CT rating	1 A	
Accuracy on rated frequency range	Class 3 and Class 1	
Rated frequency	50 or 60 Hz	
Rated frequency range	47 to 500 Hz	
Security factor	6	
Operating range	5 A to 1800 A	
Rated continuous thermal current	600 A	
Rated short-time thermal current (I <sub>th</sub> ) (CT in short-circuit)	25 kA during 1 s	
Secondary voltage without charge for a primary current, varying from 0 to 12.5 kA and varying from 0 to 50 kA	< 1000 V rms < 5000 V peak	
Isolation voltage (wiring included)	4 kV 50 Hz 1 minute in common mode	
Impulse test 1.2/50 μs (wiring included)	5 kV peak in common mode and differential mode	

# Easergy T300 Installation accessories

The different accessories used with the SC150 are summarized in the table below.

		Description	Part #
<b>Current sensors kit</b>			
PM106250		+	PM106347 
		<ul style="list-style-type: none"> <li>3 encapsulated phase split CT class 3, and 1 CTs cable connection with screw connectors</li> </ul>	EMS58171
		<ul style="list-style-type: none"> <li>3 encapsulated phase split CT 500/1, class 1, and 1 CTs cable connection with screw connectors</li> </ul>	EMS58182
PM106500		+	PM106347 
		<ul style="list-style-type: none"> <li>1 encapsulated split core balanced CT, and 1 CT cable connection with screw connectors</li> </ul>	EMS58111
<b>MV Switchgear motor connection cable</b>			
PM106313			
		<p>The connection cable for wiring to the MV cubicle is available with several lengths and comprises:</p> <ul style="list-style-type: none"> <li>One 10-pin tamper-proof connector</li> <li>One labelled connection cable: cable cross-section 1.5 mm<sup>2</sup></li> </ul>	EMS58791 to 795
PM106315			
		<p>The cubicle connector is also available without cable.</p> <p><i>Note: the cubicle connection cable is not supplied with the T300-OVR. It is an option that can be ordered with the Ringmaster cubicle.</i></p>	EMS58770
<b>PPACS cable</b>			
PM104552			
		<p>The PPACS cable for wiring to the MV cubicle is available with several lengths and comprises:</p> <ul style="list-style-type: none"> <li>Three voltage sockets for connection to the capacitive divider of the three separate connectors of each phase cable</li> <li>One Harting connector for the connection to the T300-SC150 via LVCx cable and PPACS adapter</li> </ul>	EMS58381 to 385
<b>Outdoor indicator lamp</b>			
PM106322			
PM106323			
		<ul style="list-style-type: none"> <li>An external lamp can be connected to the SC150 module of the T300 to indicate a fault current detection</li> <li>The output is powered to allow rhythmic illumination of the lamp</li> <li>Characteristics:                             <ul style="list-style-type: none"> <li>Sealed 6 V lamp: IP54</li> <li>Connection by 1.5 mm<sup>2</sup> cable (not supplied)</li> <li>Period of flash 1 s</li> </ul> </li> </ul>	59998
<b>Cellular antenna</b>			
PE55302			
		<p>Depending the installation and the cabinet, the external antenna for mobile data modem is requested in order to have a good transmission coverage.</p> <p>Two versions are available :</p> <ul style="list-style-type: none"> <li>Outdoor version with 5m cable and type N connector. Must be used with surge arrester</li> <li>Indoor version with 5m cable and type SMA connector</li> </ul>	EMS59160 EMS59162
<b>GPS antenna</b>			
PM106744			
		<p>External GPS antenna for HU250 clock synchronisation with modem 4G.</p> <ul style="list-style-type: none"> <li>Main Characteristics:                             <ul style="list-style-type: none"> <li>Time synchronisation accuracy: 1 ms</li> <li>Frequency: 1575 +/- 3 MHz</li> <li>Bandwith: min 10 MHz</li> <li>Connector: SMA</li> <li>Cable length: 5 m</li> <li>Mounting: magnetic base</li> </ul> </li> </ul>	EMS59161

# Schneider Electric Service



# Schneider Electric Service

---

Providing peace of mind throughout your installation life cycle	114
--	-----

---

Endorsing the most eco-friendly products in the industry: Green Premium™	115
---	-----

---

# Providing peace of mind throughout your installation life cycle

How can you cut costs and improve performance at the same time?

When it comes to your electrical distribution infrastructure, the answer is straight-forward - get professional expertise.

## Life cycle services

DM4109843

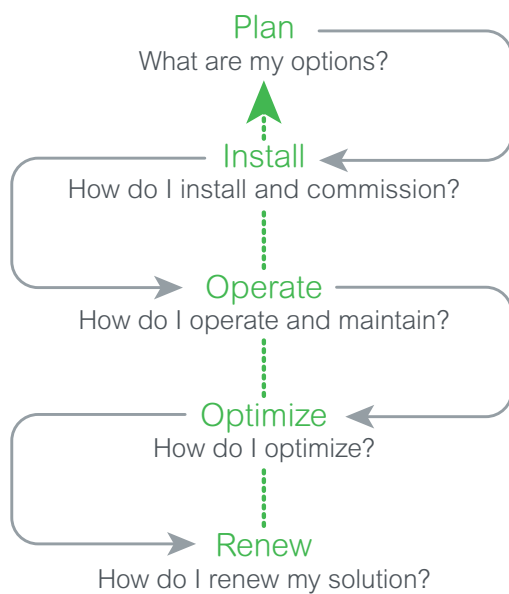

When it comes to your electrical distribution installation, we can help you:

- Increase productivity, reliability, and safety
- Mitigate risk and limit downtime
- Keep equipment up to date and extend its lifespan
- Cut costs and increase savings
- Improve your return on investment

### CONTACT US!

[www.schneider-electric.com/electricaldistributionervices](http://www.schneider-electric.com/electricaldistributionervices)

## Plan

We help you plan the full design and execution of your solution, looking at securing your process and optimizing your time:

- **Technical feasibility studies:**  
Accompany you to design a solution in your given environment
- **Preliminary design:**  
Accelerate turnaround time to come to a final solution design

## Install

We help you install efficient, reliable, and safe solutions based on your plans:

- **Project management:**  
Designed to help you complete your projects on time and within budget
- **Commissioning:**  
Ensure your actual performance versus design, through on-site testing and commissioning, tools, and procedures

## Operate

We help you maximize your installation uptime and control your capital expenditures through our service offering:

- **Asset operation solutions**
- **Advantage service plans**
- **On-site maintenance services**
- **Spare parts management**
- **Technical training**

## Optimize

We provide recommendations to improve your safety, availability, reliability, and quality:

- **MP4 electrical assessment:**  
Define your improvement and risk management program

## Renew

We extend the life of your system while providing upgrades and offers to take full responsibility for the end-of-life processing of old electrical equipment:

- **Retrofit:**  
Keep up to date and improve the performance of your electrical installations
- **MV product end of life:**  
Recycle and recover your outdated equipment with end-of-life services

## Endorsing the most eco-friendly products in the industry



Green Premium is the only label that allows you to effectively develop and promote an environmental policy whilst preserving your business efficiency. This ecolabel guarantees compliance with the most up-to-date environmental regulations, but it does more than this.

Our Green Premium ecolabel is committed to offering transparency by disclosing extensive and reliable information related to the environmental impact of its products:

### RoHS

Our products are subject to RoHS requirements at a worldwide level, even for the many products that are not required to comply with the terms of the regulation. Compliance certificates are available for products that fulfill the criteria of this European initiative, which aims to eliminate hazardous substances.

### REACH

We apply the strict REACH regulation to our products at a worldwide level and disclose extensive information concerning the presence of SVHC (Substances of Very High Concern) in all of these products.

### PEP: Product Environmental Profile

Assumption data, for each of the lifecycle phases on all of our products, in compliance with the ISO 14025 PEP ecopassport program. PEP is especially useful for monitoring, controlling, saving energy, and/or reducing carbon emissions.

### EoLI: End of Life Instructions

Available at the click of a button, these instructions provide:

- Recyclability rates for our products.
- Guidance for mitigating personnel hazards during the dismantling of your products and before recycling operations.
- Parts identification for recycling or for selective treatment, to mitigate environmental hazards/incompatibility with standard recycling processes.



Discover what we mean by green ....

**Check your products!**

Over **75%** of our manufactured products have been awarded the Green Premium ecolabel

# Commercial references

# Commercial references

---

<b>Digital configuration and ordering tools</b>	<b>118</b>
<hr/>	
<b>Easergy T300</b>	<b>119</b>
Easergy HU250: Head unit and communication interfaces	119
Easergy SC150: Switchgear controller and option	120
Easergy LV150 : Low Voltage monitoring	120
Easergy PS50/PS25: Power supply	120
Cabinet integration	121
<hr/>	
<b>Accessories</b>	<b>122</b>
Voltage sensors and adapter	122
Communication accessories	122
Current sensors	123
Switchgear connection kit	123
Outdoor indicator lamp	123
Communication accessories	123
<hr/>	
<b>Tools</b>	<b>124</b>
<hr/>	

# Digital configuration and ordering tools

**EASERGY T300 CONFIGURATOR:**  
 The unique web tool to quickly and easily configure your Easergy T300 Feeder RTU.

## Fast and simple

You will find a detail of Easergy T300 offer on the Schneider Electric Website.

The commercial reference with description is available on the product selector and a webconfigurator allows you to define a configuration for Cabinet, OEM solution and accessories:

<http://www.schneider-electric.com/en/product-range-presentation/62399-easergy-t300>



# Easergy T300

Number of identical T300 configurations ordered

- Please indicate the Part No. (for example: **EMS59000**) to your Schneider Electric correspondent.
- For other variants please contact your Schneider Electric correspondent

The order forms can be used to define T300 accessories.

Check the boxes  that match your choices.

Easergy HU250:  
Head unit and  
communication  
interfaces

Part No.	Qty.	Designation
----------	------	-------------

### Model

EMS59000	<input type="checkbox"/>	Easergy HU250: Head Unit gateway
EMS59010	<input type="checkbox"/>	HU250 set of connectors
EMS59528	<input type="checkbox"/>	10 Ethernet jumper module LAN connection

### Communication interfaces

EMS59150	<input type="checkbox"/>	Empty modem box for Easergy HU250
EMS59151	<input type="checkbox"/>	RS232-485 modem box for Easergy HU250
EMS59152	<input type="checkbox"/>	2G/3G modem box for Easergy HU250
EMS59154	<input type="checkbox"/>	4G US standard modem box for Easergy HU250
EMS59155	<input type="checkbox"/>	4G EU standard modem box for Easergy HU250

### Protocols

EMS59020	<input type="checkbox"/>	IEC 60-870-5-101 slave
EMS59021	<input type="checkbox"/>	DNP3 serial slave
EMS59032	<input type="checkbox"/>	Modbus serial master
EMS59040	<input type="checkbox"/>	IEC 60-870-5-104 slave
EMS59041	<input type="checkbox"/>	DNP3 slave TCP
EMS59042	<input type="checkbox"/>	Modbus slave TCP
EMS59061	<input type="checkbox"/>	DNP3 master TCP
EMS59060	<input type="checkbox"/>	IEC 60-870-5-104 master

### Customer database and configuration

EMS59640	<input type="checkbox"/>	Standard configuration and setting
----------	--------------------------	------------------------------------

### Language

EMS59540	<input type="checkbox"/>	English
EMS59541	<input type="checkbox"/>	French

# Easergy T300

## Easergy SC150: Switchgear controller and option

Part No.	Qty.	Designation
----------	------	-------------

### Module variant

EMS59201	<input type="checkbox"/>	Easergy SC150-CT-LPVT/VT: Switch controller with std current CT and LPVT-VT voltage sensors
EMS59202	<input type="checkbox"/>	Easergy SC150-CT-CAPA :Switch controller with std current CT and VPIS/VDS/PPACS voltage sensors
EMS59220	<input type="checkbox"/>	SC150 set of connectors

### Firmware options

EMS59230	<input type="checkbox"/>	Broken conductor detection
EMS59231	<input type="checkbox"/>	Power measurement
EMS59232	<input type="checkbox"/>	Power quality

## Easergy LV150 : Low Voltage monitoring

Part No.	Qty.	Designation
----------	------	-------------

### Module variant

EMS59300	<input type="checkbox"/>	LV150: Low Voltage Power monitoring
EMS59320	<input type="checkbox"/>	Set of connectors for Easergy LV150

### Software Options

EMS59330	<input type="checkbox"/>	Broken conductor detection
EMS59331	<input type="checkbox"/>	Power quality measurement

## Easergy PS50 / PS25: Power supply

Part No.	Qty.	Designation
----------	------	-------------

### Power supply module

EMS58587	<input type="checkbox"/>	Easergy PS50-24V: backup power supply 24V output for motor
EMS58588	<input type="checkbox"/>	Easergy PS50-48V: backup power supply 48V output for motor
EMS58585	<input type="checkbox"/>	Easergy PS25-12V: backup power supply 12V output
EMS58586	<input type="checkbox"/>	Easergy PS25-24V: backup power supply 24V output

### Battery

EMS58590	<input type="checkbox"/>	PS50 set of connectors
EMS58582	<input type="checkbox"/>	12V - 24 AH 10 years lifespan
EMS58583	<input type="checkbox"/>	12V - 38 AH 10 years lifespan
EMS58584	<input type="checkbox"/>	12V - 2.5 AH 5 years lifespan
EMS58589	<input type="checkbox"/>	12V - 5.5 AH 10 years lifespan



# Easergy T300

## Cabinet integration (only cabinet and accessories)

Part No.	Qty.	Designation
<b>Indoor controller cabinet</b>		
EMS59450	<input type="checkbox"/>	Easergy T300-IV1-1 SW: for 1 SC150
EMS59451	<input type="checkbox"/>	Easergy T300-IV1-2 SW: for 2 SC150
EMS59452	<input type="checkbox"/>	Easergy T300-IV1-3 SW: for 3 SC150
EMS59453	<input type="checkbox"/>	Easergy T300-IV1-4 SW: for 4 SC150
<b>Outdoor controller cabinet</b>		
EMS59470	<input type="checkbox"/>	Easergy T300-OVR-1 SW: for 1 SC150
EMS59471	<input type="checkbox"/>	Easergy T300-OVR-2 SW: for 2 SC150
EMS59472	<input type="checkbox"/>	Easergy T300-OVR-3 SW: for 3 SC150
EMS59473	<input type="checkbox"/>	Easergy T300-OVR-4 SW: for 4 SC150
<b>Indoor and outdoor controller cabinet</b>		
EMS59480	<input type="checkbox"/>	Easergy T300-OM1: up to 6 modules
<b>Cabinet options</b>		
EMS59510	<input type="checkbox"/>	Cabinet door status
EMS59511	<input type="checkbox"/>	CT terminal block_1sw
EMS59512	<input type="checkbox"/>	CT terminal block_2sw
EMS59513	<input type="checkbox"/>	CT terminal block_3sw
EMS59514	<input type="checkbox"/>	CT terminal block_4sw
EMS59515	<input type="checkbox"/>	Radio kit
EMS59516	<input type="checkbox"/>	Transmission device plate
EMS59517	<input type="checkbox"/>	PPACS terminal bloc
EMS59518	<input type="checkbox"/>	GPRS antenna connector and surge

## Voltage sensors and adapter

Part No.	Qty.	Designation
<b>Voltage adapter</b>		
EMS59570	<input type="checkbox"/>	VPIS VO RJ45
EMS59571	<input type="checkbox"/>	VDS RJ45
EMS59572	<input type="checkbox"/>	VT voltage adapter (SC150)
EMS59573	<input type="checkbox"/>	LPVT RJ45-RJ45 hub
ENS59574	<input type="checkbox"/>	LV AC voltage adapter (LV150)
EMS59575	<input type="checkbox"/>	PPACS
<b>Ethernet cable</b>		
59660	<input type="checkbox"/>	CCA770 L-0.6 m: Voltage adapter RJ45 connection cable
59661	<input type="checkbox"/>	CCA770 L-2 m: Voltage adapter RJ45 connection cable
59662	<input type="checkbox"/>	CCA770 L-4 m: Voltage adapter RJ45 connection cable
<b>LVPT sensors</b>		
03816498N0	<input type="checkbox"/>	LPVT-24kV
<b>VPIS V3 with Voltage Output</b>		
VPI62613	<input type="checkbox"/>	VPIS-VO: VPI62613
VPI62614	<input type="checkbox"/>	VPIS-VO: VPI62614
VPI62615	<input type="checkbox"/>	VPIS-VO: VPI62615
VPI62616	<input type="checkbox"/>	VPIS-VO: VPI62616
VPI62617	<input type="checkbox"/>	VPIS-VO: VPI62617
VPI62618	<input type="checkbox"/>	VPIS-VO: VPI62618
VPI62619	<input type="checkbox"/>	VPIS-VO: VPI62619
<b>PPACS sensors</b>		
EMS58378	<input type="checkbox"/>	PPACS divider capacitor connector
EMS58381	<input type="checkbox"/>	PPACS cable 2 m
EMS58382	<input type="checkbox"/>	PPACS cable 3 m
EMS58383	<input type="checkbox"/>	PPACS cable 5 m
EMS58385	<input type="checkbox"/>	PPACS cable 10 m

## Current sensors

Part No.	Qty.	Designation
<b>MV Fault Passage Indicator sensors</b>		
EMS58175	<input type="checkbox"/>	3 split core CT 500/1 class 3 - 47 mm (to be ordered with one of the CT cable below)
EMS58171	<input type="checkbox"/>	3 split core CT 500/1 class 3 - 47 mm + CT cable with screw connectors
EMS58111	<input type="checkbox"/>	1 split core balanced CT 500/1 class 3 - 120 mm + CT cable with screw connectors
EMS58183	<input type="checkbox"/>	3 split core CT 500/1 class 1 - 47 mm (to be ordered with one of the CT cable below)
EMS58182	<input type="checkbox"/>	3 split core CT 500/1 class 1 - 47 mm + CT cable with screw connectors
<b>CT cable</b>		
EMS58132	<input type="checkbox"/>	3 Phase cable - 3 meters
EMS58133	<input type="checkbox"/>	3 Phase cable - 5 meters
EMS58135	<input type="checkbox"/>	3 Phase cable - 10 meters
EMS58137	<input type="checkbox"/>	3 Phase cable - 15 meters

## Switchgear connection kit

Part No.	Qty.	Designation
EMS58770	<input type="checkbox"/>	T300-CP00: Without switch cable
EMS58791	<input type="checkbox"/>	T300-CP03: 3 m MV switch motorization cable
EMS58792	<input type="checkbox"/>	T300-CP05: 5 m MV switch motorization cable
EMS58793	<input type="checkbox"/>	T300-CP10: 10 m MV switch motorization cable
EMS58794	<input type="checkbox"/>	T300-CP15: 15 m MV switch motorization cable
EMS58795	<input type="checkbox"/>	T300-CP25: 25 m MV switch motorization cable

## Outdoor indicator lamp

Part No.	Qty.	Designation
59988	<input type="checkbox"/>	Outdoor Fault Passage Indicator lamp

## Communication accessories

Part No.	Qty.	Designation
<b>Antenna</b>		
EMS59160	<input type="checkbox"/>	Outdoor 3G/4G antenna connector type N 5m cable used with surge connector
EMS59162	<input type="checkbox"/>	Outdoor 3G/4G antenna connector type SMA 5m cable direct connection to modem box
EMS59518	<input type="checkbox"/>	3G/4G surge connector for external antenna with cable for HU250 connection



# TOOLS

[schneider-electric.com](https://schneider-electric.com)

This international web site allows you to access all the Schneider Electric solutions and product information via:

- Comprehensive descriptions
- Range datasheets
- A download area
- Product selectors

You can also access information dedicated to your business and contact your Schneider Electric country support.



PM1103687



# TOOLS

## Web selector

This site allows you to access Schneider Electric products in just two clicks via a comprehensive range of datasheets, with direct links to:

- Complete libraries: technical documents, catalogs, FAQs, brochures
- Selection guides from the e-catalog
- Product discovery sites and their animations

You will also find illustrated overviews, news to which you can subscribe, and a list of country contacts

## Training

Training allows you to acquire the expertise (installation design, working with power on, etc.) to increase efficiency and improve customer service.

The training catalog includes beginner's courses in electrical distribution, knowledge of MV and LV switchgear, operation and maintenance of installations, and design of LV installations, to give a few examples.

Schneider Electric Industries SAS

35 rue Joseph Monier  
92500 Rueil-Malmaison, France  
Tel : +33 (0)1 41 29 70 00

[www.schneider-electric.com](http://www.schneider-electric.com)

February 02, 2018  
NRJED314621EN

©2018 Schneider Electric SE. All rights reserved.  
All Schneider Electric trademarks and service marks are the property of Schneider Electric SE, its subsidiaries and affiliated companies.